

Urban Watershed Forestry Manual

Part 2: Conserving and Planting Trees at Development Sites



United States Department of Agriculture
Forest Service
Northeastern Area
State and Private Forestry
NA-TP-01-06
May 2006

Urban Watershed Forestry Manual

Part 2. Conserving and Planting Trees at Development Sites

Second in a Three-Part Manual Series on Using Trees to Protect and Restore Urban Watersheds

Prepared by:

Karen Capiella, Tom Schueler, and Tiffany Wright
Center for Watershed Protection
8390 Main Street, Second Floor
Ellicott City, MD 21043
www.cwp.org
www.stormwatercenter.net

Prepared for and published by:

United States Department of Agriculture
Forest Service
Northeastern Area
State and Private Forestry
11 Campus Boulevard, Suite 200
Newtown Square, PA 19073
www.na.fs.fed.us

May 2006



ABOUT THIS MANUAL SERIES

This manual is the second in a three-part series on using trees to protect and restore urban watersheds. A brief description of each part follows.

Part 1. Methods for Increasing Forest Cover in a Watershed introduces the emerging topic of urban watershed forestry. This part also presents new methods for the watershed planner or forester, to systematically measure watershed forest cover and select the best methods for maintaining or increasing this cover by protecting, enhancing, and reforesting large parcels of primarily public land across the watershed. These methods are based on extensive review of the latest research and input from experts in a wide range of related fields.

Part 2. Conserving and Planting Trees at Development Sites presents specific ways to enable developers, engineers, or landscape architects to incorporate more trees into a development site. The proposed approach focuses on protecting existing trees, planting trees in storm water treatment practices, and planting trees in other open spaces at a development site. This part introduces conceptual designs for storm water treatment practices that utilize trees as part of the design (referred to as storm water forestry practices.) These designs were developed with input from experts in storm water engineering, forestry, and a range of related fields.

Part 3. Urban Tree Planting Guide provides detailed guidance on urban tree planting that is applicable at both development site and watershed scales. Topics covered include site assessment, planting design, site preparation and other pre-planting considerations, and planting and maintenance techniques. An Urban Tree Selection Guide is included for use in selecting the best tree and shrub species for the planting site.

Urban watershed forestry is a new practice that draws from multiple disciplines, including forestry, hydrology, engineering, landscape architecture, mapping, planning, and soil science. Consequently, some ideas drawn from each discipline have been simplified in this manual series in order to be easily understood by a diverse audience. In addition, the latest and most relevant research from each discipline has been used to support the new practice. The research summarized in these manuals, however, is not intended to provide a comprehensive literature review.

This manual series draws heavily upon research and examples from the Chesapeake Bay watershed and the northeastern region of the United States. The manuals primarily apply to these regions, and may also apply in other humid regions of the country where the natural vegetative cover is predominately forest. Finally, several elements in the manuals are brand new and will require additional testing, research, and analysis. We welcome future additions to the methodology, techniques, and designs presented.

ACKNOWLEDGMENTS

This manual was developed by the Center for Watershed Protection in cooperation with the USDA Forest Service, Northeastern Area State and Private Forestry. Funding for this project was provided by the USDA Forest Service, through the Chesapeake Bay Program Forestry Workgroup, under grant number 03-DG-11244225-163. Portions of this manual were funded by cooperative agreement CP-82981501 with the U.S. Environmental Protection Agency, Office of Water.

The preparation of the manual was greatly influenced by two design workshops held in Annapolis, MD, in winter 2004. The first workshop focused on developing conceptual designs for integrating trees and storm water treatment practices, while the second workshop developed guidelines for planting trees in specific urban locations. More than 40 local, regional, and national experts participated in the workshops, including foresters, storm water engineers, landscape architects, arborists, urban soil scientists, watershed planners, and representatives from parks, and transportation and utility companies.

The Center for Watershed Protection project team included:

- Karen Cappiella
- Tom Schueler
- Ted Brown
- Chris Swann
- Tiffany Wright

Special thanks go to Stephanie Sprinkle for her assistance in organizing the workshops, to Neely Law for providing an editorial review of the manual, and to Sarah Weammert, Bryan Astheimer, and Anne Kitchell for their research contributions.

Thanks are extended to the following individuals at the USDA Forest Service: Watershed Project Officer Al Todd, for his patience, insights, and contributions throughout the duration of this project; Jennifer Curkendall, for her assistance in organizing the workshops and for reviewing the materials produced; Ken Belt, Richard Pouyat, Phillip Rodbell for providing comments and input throughout the project; Roderick Salguero and Lisa Hoover, for valuable assistance in developing the Urban Tree Selection Guide; and Matt Arnn, for developing the graphics for this manual.

Thanks go, too, to the following reviewers of Part 2:

- Sherri Albrecht, URS Corporation
- Stewart Comstock, Maryland Department of the Environment
- Jennifer Curkendall, USDA Forest Service
- Mark Green, City of Topeka, KS
- Dudley Hartel, Southern Center for Urban Forestry Research and Information
- Phillip Rodbell, USDA Forest Service
- Al Todd, USDA Forest Service
- Roberta Zwier, AMEC Earth and Environmental

In addition, many of the concepts presented in this manual were developed by these participants of the two design workshops:

- Matt Arnn, USDA Forest Service
- Miles Barnard, Southfork Studios

Acknowledgments

- Ken Belt, USDA Forest Service
- Ted Brown, Center for Watershed Protection
- Rick Brush, Montgomery County, MD, Department of Permitting Services
- Karen Capiella, Center for Watershed Protection
- Sally Claggett, USDA Forest Service
- Steve Cohen, KCI Technologies, Inc.
- Stewart Comstock, Maryland Department of the Environment
- Martha Corrozi, Chesapeake Bay Program
- Martin Covington, Carroll County, MD, Bureau of Resource Management
- Jennifer Curkendall, USDA Forest Service
- Doug Curtis, National Park Service, U.S. Department of the Interior
- Allen Davis, University of Maryland
- Barbara Deutsch, Casey Tree Endowment
- Mike Galvin, Maryland Department of Natural Resources
- Steve Genua, Potomac Electric Power Company (PEPCO)
- Jason Grabosky, Rutgers University
- Mark Green, City of Topeka, KS
- Guy Hager, Parks and People Foundation
- Michael Helfrich, Gamma Engineering
- Lili Herrera, Cornell University
- Brian Le Couteur, Metropolitan Washington Council of Governments
- Vicki Luther, Carroll County, MD, Bureau of Resource Management
- Reggie Parrish, U.S. Environmental Protection Agency
- Rich Pouyat, USDA Forest Service
- Graham Ray, Deep Root Partners, L. P.
- Julian Ray, Deep Root Partners, L. P.
- Phillip Rodbell, USDA Forest Service
- Frank Rodgers, Parks and People Foundation
- Tom Schueler, Center for Watershed Protection
- Richard Straight, USDA Forest Service
- Anne Strang, Maryland Department of Natural Resources Forest Service
- Chris Swann, Center for Watershed Protection
- Al Todd, USDA Forest Service
- Jim Urban, James Urban and Associates
- Charles Wallis, Maryland Department of the Environment
- Tom Whitlow, Cornell Urban Horticulture Institute
- Tiffany Wright, Center for Watershed Protection
- Kaveh Zomorodi, Dewberry and Davis
- Roberta Zwier, AMEC Earth and Environmental

Table of Contents

| | |
|---|-----|
| List of Tables | v |
| List of Figures | v |
| List of Text Boxes | vii |
| Acronyms Used | vii |
| Chapter 1: Introduction | 1 |
| Why Conserve and Plant Trees at Development Sites? | 1 |
| Benefits of Trees at Development Sites | 2 |
| Economic benefits | 2 |
| Environmental benefits | 3 |
| Community benefits | 5 |
| Regulatory Considerations for Trees at Development Sites | 6 |
| Unique Properties of the Urban Planting Environment | 8 |
| Chapter 2. How to Conserve and Plant Trees at Development Sites | 12 |
| Conserving Existing Trees During Construction | 12 |
| 1. Inventory Existing Forest..... | 12 |
| 2. Identify Trees to Protect..... | 14 |
| 3. Design the Development With Tree Conservation in Mind..... | 15 |
| 4. Protect Trees and Soil During Construction | 18 |
| 5. Protect Trees After Construction..... | 20 |
| Planting Trees at Development Sites | 20 |
| 1. Select Planting Sites..... | 20 |
| 2. Evaluate and Improve Planting Sites | 21 |
| 3. Plant and Maintain Trees | 23 |
| Chapter 3. Design and Planting Guidelines for Storm Water Forestry Practices | 24 |
| Wooded Wetland | 29 |
| Bioretention and Bioinfiltration Facilities | 35 |
| Alternating Side Slope Plantings (Swale)..... | 38 |
| Tree Check Dams (Swale) | 40 |
| Forested Filter Strip | 43 |
| Multi-Zone Filter Strip..... | 46 |
| Linear Storm Water Tree Pit | 49 |
| Chapter 4. Planting Trees Along Streets and in Parking Lots | 53 |
| Planting Trees Along Local Streets..... | 57 |
| Planting Trees in Parking Lots..... | 61 |

Appendix A. Forest Stand Delineation A-1
Appendix B. Tree Protection Specifications B-1
References References-1

List of Tables

Table 1. Economic Benefits of Trees at Development Sites 3
 Table 2. Environmental Benefits of Trees at Development Sites..... 5
 Table 3. Community Benefits of Trees at Development Sites 5
 Table 4. Regulations Related to Conserving and Planting Trees at Development Sites..... 6
 Table 5. Potential Regulatory Barriers to Tree Conservation, Planting, and Growth at
 Development Sites 7
 Table 6. Forest and Tree Inventory Guidance 13
 Table 7. Selecting Priority Trees and Forests for Conservation..... 15
 Table 8. Methods for Addressing Urban Planting Constraints 22
 Table 9. Pollutant Removal (Median %) by Standard Storm Water Treatment Practices..... 24
 Table 10. Characteristics of Storm Water Treatment Practices That May Limit Tree Growth 25
 Table 11. Inundation in Selected Storm Water Treatment Practices 26
 Table 12. Potential Engineering Conflicts and Resolutions for Planting Trees in Storm
 Water Treatment Practices 27

List of Figures

Figure 1. Large tracts of forest and mature trees can be conserved during development..... 1
 Figure 2. Healthy trees can increase property values and aid home sales. 2
 Figure 3. Trees and natural areas provide many recreational opportunities. 5
 Figure 4. Stress from harsh urban conditions can kill a street tree. 8
 Figure 5. A typical urban tree pit is about 4 feet by 4 feet and does not provide adequate soil
 volume for most trees..... 9
 Figure 6. Improper disposal of construction materials and inadequate protection negatively
 impact trees at a construction site. 9
 Figure 7. Deer browsing damages seedlings. 10
 Figure 8. Urban heat island effect—Because this tree is surrounded by pavement, it is exposed to high
 temperatures. 10
 Figure 9. A common infrastructure conflict results in tree roots lifting or cracking pavement due to
 inadequate setbacks between trees and pavement. 11
 Figure 10. A map of existing forests on a development site is one product of Forest Stand
 Delineation—a required inventory in the State of Maryland. 14

Urban Watershed Forestry Manual - Part 2

| | |
|---|----|
| Figure 11. An open space design with 72 lots uses less land than a conventional subdivision with the same number of lots. Floodplains and wetlands are considered unbuildable and must be subtracted from gross density. An alternative design provides 66 lots. | 16 |
| Figure 12. Site fingerprinting limits site disturbance to the minimum necessary for building..... | 17 |
| Figure 13. The trunk diameter method is one of four ways to define the critical root zone. | 18 |
| Figure 14. Orange plastic mesh fencing delineates tree protection areas. | 18 |
| Figure 15. Fencing surrounds a mature tree that is to be preserved. | 19 |
| Figure 16. Development sites offer several potential planting areas. | 21 |
| Figure 17. Storm water ponds with trees incorporated offer benefits over a conventional storm water pond with no trees. | 24 |
| Figure 18. Swales with trees offer greater benefits than a swale with no trees. | 25 |
| Figure 19. A storm water pond or wetland contains four planting zones. | 26 |
| Figure 20. Overgrowth of willows in this pond limits maintenance access and essentially creates a monoculture. | 28 |
| Figure 21. A wooded wetland incorporates trees into the design. | 29 |
| Figure 22. A weir wall with a v-notch and a hood resists clogging by woody debris. | 30 |
| Figure 23. A secondary riser helps to keep permanent pools at safe elevations, even when outlets clog. | 30 |
| Figure 24. Tree mounds are one feature of a wooded wetland that incorporates trees. | 31 |
| Figure 25. Tree clusters increase the soil and water volumes available for trees planted on side slopes. | 32 |
| Figure 26. Bioretention and bioinfiltration facilities remove pollutants from storm water runoff using a filter medium. | 35 |
| Figure 27. Alternating side-slope plantings are an attractive way to incorporate trees into swales without obstructing channel flow. | 39 |
| Figure 28. Tree check dams slow runoff and prevent erosion in swales with slopes of 2 percent to 6 percent. | 40 |
| Figure 29. Forested filter strip profile shows how runoff flows through the various zones. | 43 |
| Figure 30. Forested filter strip plan shows its suitability to a linear area. | 44 |
| Figure 31. A multi-zone filter strip includes four successive vegetation zones. | 46 |
| Figure 32. A multi-zone filter strip requires a minimum width of 25 feet. | 47 |
| Figure 33. A linear storm water tree pit collects and treats storm water that is directed from rooftops. | 49 |
| Figure 34. Tree pits are connected through a soil trench, and tree pit protection prevents damage from pedestrian traffic. | 50 |
| Figure 35. The environment differs drastically in a development with no street trees from one with trees that matured to form a canopy over the street. | 53 |
| Figure 36. Non-linear street tree plantings are an alternative to linear roadside plantings. | 54 |

Table of Contents

| | |
|--|----|
| Figure 37. Trees planted in a median strip provide shade, slow traffic, and make a street more attractive than one with little vegetation..... | 54 |
| Figure 38. A cul-de-sac is typically overlooked as a place to plant trees. | 54 |
| Figure 39. Trees planted in holes that are too small may eventually crack nearby pavement..... | 55 |
| Figure 40. The harsh environment of a parking lot can be tempered by including an interior planting strip that allows trees to share rooting space. | 55 |
| Figure 41. Trees can be incorporated into various planting areas along local roads. | 57 |
| Figure 42. Tree planting along local roads can utilize wide, linear planting areas to accommodate large, healthy trees. | 58 |
| Figure 43. Parking lots can be designed to provide larger spaces to plant trees..... | 61 |

List of Text Boxes

| | |
|--|----|
| Box 1. Benefits of Trees at Development Sites..... | 2 |
| Box 2. Hydrologic and Water Quality Benefits of Trees | 4 |
| Box 3. Common Causes of Urban Tree Mortality | 8 |
| Box 4. Mapping Data for Forest Inventory..... | 12 |
| Box 5. Maryland’s Forest Conservation Act..... | 13 |
| Box 6. Better Site Design Techniques to Conserve Forests..... | 17 |
| Box 7. Factors Assessed During the Urban Reforestation Site Assessment..... | 21 |
| Box 8. Design Principles for Urban Tree Planting | 23 |
| Box 9. Desirable Characteristics Of Trees For Storm Water Treatment Practices..... | 27 |

Acronyms Used

| | |
|-----|----------------------------------|
| CRZ | Critical root zone |
| FSD | Forest stand delineation |
| HOA | Homeowners’ association |
| IVM | Integrated vegetation management |
| LOD | Limits of disturbance |
| SFP | Storm water forestry practice |
| STP | Storm water treatment practice |

Chapter 1: Introduction

The purpose of this manual is to present specific strategies and practices that developers, engineers or landscape architects can use to incorporate trees into the design of development sites. This manual outlines three approaches for doing so:

1. Conserving existing trees during construction
2. Integrating trees into storm water treatment practices
3. Planting trees along local roads and in parking lots

Developers, contractors, and landscape architects can conserve and plant trees at new development and redevelopment or infill projects. On forested sites, it is most important to conserve existing forests, particularly high quality stands or large, mature trees (Figure 1). To conserve existing forests, developers should inventory the site to identify the best forested areas to protect, design the development to prevent loss of these trees, and take measures to ensure the protection of remaining trees during and after construction.

Where tree conservation is not an option, development sites provide many opportunities to plant new trees, such as in storm water treatment practices (STPs) and other pervious areas of the site. STPs treat storm water runoff by capturing and temporarily detaining water, allowing pollutants to settle out before entering local receiving waters. While some STPs are not traditionally considered appropriate for tree planting, incorporating trees and shrubs in certain areas of STPs can enhance their esthetic appeal and improve their performance. For the purposes of this manual, STPs that incorporate trees into their design are referred to as **storm water forestry practices (SFPs)**.

The remaining pervious areas of a site that are good but often overlooked candidates for tree planting include local road rights-of-way, landscaped islands in cul-de-sacs or traffic circles, and parking lots. Private lawn areas may also constitute a significant portion of green space at development sites, and developers should certainly strive to conserve or plant trees in lawns as well. Many development sites may have harsh soil and environmental conditions that need to be overcome through appropriate tree selection and proper site preparation before planting.



Figure 1. Large tracts of forest (left) and mature trees (right) can be conserved during development.
Photos: Left—Maryland Department of Natural Resources; Right—District of Columbia Department of Forestry

Why Conserve and Plant Trees at Development Sites?

Conserving or planting trees can address forest conservation, landscaping, or other site design requirements. Forest conservation and tree planting enhance the appeal of a development, increase land and housing values, and can reduce costs for construction and storm water management. Trees

also provide a wide range of environmental, economic, and community benefits (such as air and water quality improvement, reduction of storm water runoff, and wildlife habitat). These additional benefits of trees at development sites are summarized below.

BOX 1. BENEFITS OF TREES AT DEVELOPMENT SITES

Economic benefits

- Decrease heating and cooling costs
- Reduce construction and maintenance costs
- Increase property values
- Positively influence consumer behavior

Community benefits

- Improve health and well-being
- Provide shade and block ultraviolet radiation
- Buffer wind and noise

Environmental benefits

- Reduce urban heat island effect
- Enhance function of STPs

Benefits of Trees at Development Sites

Part 1 of this manual series summarizes urban forest benefits that affect watershed health. This part reviews the benefits that urban trees provide at the parcel scale, particularly those realized by the developer or homeowner. An important note is that some benefits may not be fully realized until the trees reach maturity. Benefits of trees at development sites are listed in Box 1.

Economic benefits

The values of houses in neighborhoods with abundant trees are usually higher than those of comparable houses in neighborhoods without trees (Morales, 1980; Morales and others, 1983; Anderson and Cordell, 1988) (Table 1 and Figure 2). Neighborhood natural areas also increase the value of properties located nearby (Kitchen and Hendon, 1967; More and others 1983; Correll and others, 1978) (Table 1). Additional cost benefits to the developer and ultimately the homeowner can result from conserving existing trees at a development site. Tree conservation can reduce the amount of clearing and grading, paving, and storm water management needed at sites, reducing infrastructure costs as well as reducing mowing costs in the future. Table 1 summarizes the economic benefits of trees at development sites.



Figure 2. Healthy trees can increase property values and aid home sales.

| Table 1. Economic Benefits of Trees at Development Sites | | |
|--|---|---|
| Benefit | Supporting Information | Source |
| Decrease heating and cooling costs | <ul style="list-style-type: none"> • Properly placed trees can reduce heating and cooling costs by 10% to 20% on average within 10-15 years after planting • Trees properly planted next to buildings can reduce summer air conditioning costs by 40%. Direct shading of an air conditioner can increase efficiency up to 10% • Energy use in a house with a treed lot can be 20% to 25% lower per year than for the same house in an open area | Heat Island Group (1996) Parker (1983) Heisler (1986) |
| Reduce construction and maintenance costs | <ul style="list-style-type: none"> • Developers who conserve trees can save up to \$5,000 per acre for clearing, grading, and installing erosion control practices • Developers who conserve trees can save \$2,000 to \$50,000 to treat the quality and quantity of storm water from a single impervious acre • Developers who conserve trees can save \$270 to \$640 per acre on annual mowing and maintenance costs | Schueler (1995) Schueler (2000) WHEC (1992) |
| Increase property values | <ul style="list-style-type: none"> • Property values of homes with trees are an average of 5% to 7% and as much as 20% higher than equivalent properties without trees • Two regional economic surveys document that conserving forests on residential and commercial sites can enhance property values by an average of 6% to 15% and increase the rate at which units are sold or leased. | MD DNR (n.d.) Morales (1980) and Weyerhaeuser Company (1989) |
| Positively influence consumer behavior | <ul style="list-style-type: none"> • Consumer ratings of retail establishments was up to 80% higher for business districts with street trees and other landscaping • Survey results indicated that consumers were more willing to travel farther, visit more frequently, stay longer, and pay for parking in business districts that have trees • Survey participants priced goods an average of 11% higher in landscaped business districts than in districts with no trees | University of Washington (1998) |

Environmental benefits

Trees reduce air temperatures due to the shading effect provided by their canopy and the release of water vapor through evapotranspiration. Even relatively sparse parking lot canopies can exert a significant cooling effect on parking lot climate and vehicle temperatures (Scott and others, 1998). This temperature reduction reduces the volatilization of smog precursors formed in parking lots and also translates into energy savings when trees are planted in appropriate locations near buildings (e.g., the south and west sides of the building and near air conditioning units).

Trees further increase comfort by blocking harmful ultraviolet radiation, reducing windspeed, and reducing noise from lawnmowers, traffic, and other urban sounds. To be effective at reducing noise,

Urban Watershed Forestry Manual - Part 2

a dense, tall, and wide forested buffer should be planted close to the source of the noise. Contiguous rows of trees in widths of 16 feet or more are especially effective (Trees Atlanta, n.d.). Trees also create background noise, such as rustling leaves and wind through the branches, that help to muffle other more offensive noises (Harris, 1992).

Planting trees in storm water treatment practices can increase nutrient uptake, reduce storm water runoff through rainfall interception and evapotranspiration (ET), enhance soil infiltration, provide bank stabilization, increase esthetic appeal, provide wildlife habitat, provide shading, discourage geese, and reduce mowing costs (Shaw and Schmidt, 2003). While few studies exist that directly quantify these benefits, research is available on rainfall interception and ET rates, as well as pollutant removal for individual trees. This data, presented in Box 2, suggests that incorporating trees into STPs may increase their pollutant removal efficiencies. Median pollutant removal efficiencies for standard STPs are presented in Chapter 3. The environmental benefits of trees at development sites are summarized in Table 2.

BOX 2. HYDROLOGIC AND WATER QUALITY BENEFITS OF TREES

This box summarizes data on rainfall interception, evapotranspiration, and nutrient uptake for a single tree. Based on this data, the potential reduction of storm water runoff by each tree planted in an STP is 860 gallons per year, and the potential nitrogen reduction by each tree is 0.05 pounds per year.

| Hydrologic and Water Quality Benefits of Trees | | |
|--|---|---|
| Benefit | Per Tree Annual Quantification of Benefit | Source and Description |
| Rainfall interception | 760 gallons of water per tree per year | Annual rainfall interception by a large deciduous front yard tree* (CUFR, 2001) |
| Evapotranspiration | 100 gallons of water per tree per year | Transpiration rate of poplar trees for one growing season (EPA, 1998) |
| Nutrient uptake | 0.05 pounds nitrogen per tree per year | Based on daily rate of nitrogen uptake by poplar trees (Licht, 1990) |

*A 40-year-old London plane tree growing in a semi-arid climate

Trees also show enormous potential to remove other pollutants, such as metals, pesticides, and organic compounds. The process of using plants to remove contamination from soil and water is called **phytoremediation**. This process has mainly been applied to soil and groundwater but could easily be applied to storm water runoff. Trees such as poplars that can absorb large quantities of water through evapotranspiration are typically used for phytoremediation because this type of consumption contains and controls the migration of contaminants (EPA, 1998). Many other plants have the ability to absorb excess nutrients, filter sediments, and break down pollutants commonly found in storm water runoff. One sugar maple (1 foot in diameter) along a roadway was shown to retain 60 milligrams (mg) cadmium, 140 mg chromium, 820 mg nickel and 5,200 mg lead from the environment in one growing season (Coder, 1996).

| Table 2. Environmental Benefits of Trees at Development Sites | | |
|---|--|--|
| Benefit | Supporting Information | Source |
| Reduce urban heat island effect | <ul style="list-style-type: none"> • Air temperatures can be 4 to 8 degrees Fahrenheit (°F) cooler in well-shaded parking lots than in unshaded parking lots. Similarly, air temperatures in neighborhoods with mature canopy were 3 to 6 °F lower in daytime than in newer neighborhoods with no trees. • Trees reduce surface asphalt temperatures by up to 36 °F, and vehicle cabin temperatures by 47 °F | <p>McPherson (1998), Akbari and others (1992)</p> <p>CUFR (2001)</p> |
| Enhance function of STPs | <ul style="list-style-type: none"> • Trees in storm water treatment practices influence evapotranspiration and capacity for nutrient uptake, aid infiltration, provide bank stabilization, increase esthetic appeal, provide wildlife habitat, provide shading, and reduce mowing costs | Shaw and Schmidt (2003) |

Community benefits

Trees at development sites also provide benefits to the community that are equally important but difficult to quantify. These benefits include increased physical comfort due to reduction of wind and noise and provision of shade, esthetic and sentimental value, improved physical and psychological well-being, enhanced sense of community, and increased opportunities for recreation (Figure 3). Overall, trees increase the livability of a community. Trees create a sense of privacy in urban environments, reduce stress, and have been linked to less crime. Table 3 summarizes some of the research on community benefits of trees in neighborhoods.



Figure 3. Trees and natural areas provide many recreational opportunities. *Photo: NRCS photo gallery*

| Table 3. Community Benefits of Trees at Development Sites | | |
|---|---|---|
| Benefit | Supporting Information | Source |
| Improve health and well-being | <ul style="list-style-type: none"> • Recuperation rates were faster for patients whose windows offered views of a wooded landscape. • Less violence occurred in urban public housing where there were trees. | <p>Ulrich (1984)</p> <p>Sullivan and Kuo (1996)</p> |
| Provide shade and block ultra-violet radiation | <ul style="list-style-type: none"> • Trees with the right shade and density can block up to 95% of incoming radiation. • Even leafless trees can intercept up to 50% of the sun’s energy. | Akbari and others (1992) |
| Buffer wind and noise | <ul style="list-style-type: none"> • Depending on housing density, an added 10% tree cover can reduce windspeed by 10% to 20%, while an added 30% tree cover can reduce windspeed by 15% to 35%. Even in winter, trees can reduce windspeeds by as much as 50% to 90% of summer values. • A belt of trees 98 feet wide and 49 feet tall has been shown to reduce highway noise by 6 to 10 decibels, a rate of almost 50%. | <p>Heisler (1989)</p> <p>Akbari and others (1992)</p> |

Regulatory Considerations for Trees at Development Sites

Conserving existing trees and planting new ones at development sites can have regulatory implications, in the form of both incentives and barriers. Depending on local codes and ordinances regulating site design, several regulations may be met by preserving or planting trees at a development site. Additional voluntary or incentive programs may exist that can provide even more reasons to conserve trees, such as tax breaks or density bonuses. Part 1 of this manual series provides details and examples of these regulatory and incentive programs that relate to forest conservation. Table 4 summarizes regulations related to conserving and planting trees at development sites.

The same local codes and ordinances governing site development can also limit tree preservation or tree planting in particular areas of a development site, whether intentional or not. For example, guidelines provided for design of planting strips, such as medians and islands, may not produce an environment conducive to supporting healthy, mature trees. Table 5 summarizes the potential barriers to conserving and planting trees at development sites. While these barriers can sometimes be addressed, it is important to become familiar with local codes before planting.

| Regulation | Description |
|------------------------------------|--|
| Landscaping | Landscaping is typically required in parking lots in the form of a minimum percentage of the total area. Landscaped buffers may also be required to screen parking lots and other land uses from adjacent roads and developments. Street trees may be required along local roads. Conserving existing trees within these locations or planting new ones will meet most landscaping requirements. |
| Storm water management | Through a storm water credit program, developers can get credits for conserving tracts of forest and may be allowed to subtract this area from the total site area when computing storm water runoff volumes to treat. In addition, required landscaped areas can also be used for storm water treatment, meeting both landscaping and storm water management requirements. |
| Forest conservation and protection | Regulations may state that a certain percentage of forest must be preserved at each site or that trees of a certain size must be protected. |
| Conservation of natural areas | Certain regulations, such as stream buffer ordinances and floodplain ordinances, may exist that require natural areas such as stream buffers, floodplains, steep slopes, or otherwise unbuildable areas be protected and preserved during development. |
| Open space design for subdivisions | Requires clustering of homes on a development site to conserve a certain percentage of natural area such as forest. |
| Canopy requirements | Typically apply to parking lots or street trees and require a certain percentage of canopy cover to be met within a specified time frame. |
| Erosion and sediment control | Temporary tree protection devices installed before construction can be combined with erosion and sediment control devices, and can potentially save money. |

A recommended approach to address regulatory barriers to tree conservation is to conduct a local site planning roundtable in the community. As part of the local site planning roundtable process, an audit of codes and ordinances governing site development is conducted to identify potential barriers to implementing environmental-friendly site design techniques, such as forest conservation and tree planting. In addition, roundtables help identify language that discourages the use of environmentally friendly techniques by requiring extra costs or a longer review process, even though the technique may not specifically be prohibited. The goal of the site planning roundtable is to make recommendations for revising the codes and ordinances to allow and encourage the use of the desired site design practices. Additional guidance on site planning roundtables is provided in CWP (1998).

| Table 5. Potential Regulatory Barriers to Tree Conservation, Planting, and Growth at Development Sites | |
|---|---|
| Regulation | Description |
| Street trees | Required width of planting area may not provide adequate soil volume for trees. Buffer strip is typically required to be located between the sidewalk and street, further limiting potential rooting space. Setbacks between trees and infrastructure may not be adequate to prevent damage to trees. |
| Parking lot landscaping | Required size of parking lot islands may not provide adequate soil volume for trees. Setbacks between trees and infrastructure may not be adequate to prevent damage to trees. |
| Lot design | Required building setbacks and frontages may limit placement of buildings and pavement on the site and decrease the feasibility of conserving remaining forest areas. |
| Septic systems | Regulations may require clearing of reserve fields at the time of development. |
| Landscaping for STPs | Guidance may prohibit trees in some or all practices, or within certain areas of practices, such as pond embankments. |
| Floodplain | Within designated floodways, trees may be prohibited (usually regulated by U.S. Army Corps of Engineers). |
| Subdivision design | Conventional subdivision design standards may not allow for conservation of natural areas such as forest. Road design standards for subdivision may prohibit use of landscaped island in cul-de-sac. |
| Parking ratios | Excessive minimum parking ratios can create large unused parking areas that limit potential for tree conservation. |
| Utilities, signs, and lighting | Regulations may not allow tree planting within utility easements or rights-of-way. In urban environments, adequate space for necessary setbacks between infrastructure and trees may not exist, which can result in limited growing space for trees and potential conflicts between trees and infrastructure. |

Unique Properties of the Urban Planting Environment

The average life expectancy of newly planted urban trees has been reported to be 10 to 15 years (Urban, 1999). Urban street trees may have an even lower life expectancy of 7 to 10 years (Appleton and others, 2002). Planted in a better environment, these same trees would have a life expectancy of 60 to 200 years. Why is there such a significant difference? One reason is the harsh planting environment in urban areas that often provides poor conditions for tree growth (Figure 4).

Another major reason for lowered tree life expectancy can be the lack of maintenance provided for urban street trees. Many municipalities actually find it easier and cheaper to replace street trees on a regular cycle rather than to provide adequate conditions and care needed to allow for long-term tree survival. Replacing urban street trees, however, does not offset the additional loss of trees from land development and mortality due to a harsh urban microclimate. A study of tree mortality rates in Baltimore found an annual rate of 6.6%. Even when combined with reforestation efforts, this mortality



Figure 4. Stress from harsh urban conditions can kill a street tree.
Photo: Edward F. Gilman

rate resulted in a net loss of 4.2% in the number of city trees (Nowak and others, 2004). This reality reinforces the need to prioritize retention of existing established urban trees rather than relying on replanting.

Some common causes of urban tree mortality are listed in Box 3 and described below. While not presented in any particular order, one study of urban tree mortality concluded that drought was the most common factor (Foster, 1978). Causes of tree mortality are often difficult to pinpoint because the decline from many impacts can take years to appear.

BOX 3. COMMON CAUSES OF URBAN TREE MORTALITY

- Limited soil volume
- Poor soil quality
- Air pollution
- Construction activities
- Physical damage from lawnmowers, vandalism, or vehicles
- Damage from insects or animals
- Soil compaction from heavy foot traffic
- Exposure to pollutants in storm water runoff
- Soil moisture extremes
- Exposure to wind and high temperatures
- Competition from invasive plant species
- Improper planting and maintenance techniques
- Conflicts with infrastructure
- Disease
- Poor nursery production practices

Limited soil volume

Urban areas often have limited space available for planting due to the presence of infrastructure. Highly compacted soils also effectively prevent tree roots from growing outside the tree pit (Figure 5). The average urban tree pit contains only 40 cubic feet of soil; however, a large tree needs at least 400 cubic feet—and optimally 1,000 cubic feet—of soil to thrive (Urban, 1999).

Poor soil quality

Most urban soils are highly compacted, have poor drainage, and are low in organic matter and nutrients (Craul, n.d.). The pH is often elevated from calcium deposits from building rubble, irrigation water, and road salt (Craul, n.d.). Soil compaction from construction and heavy use limits root growth and starves the tree of oxygen, nutrients, and water.

Air pollution

Air pollutants such as ozone damage tree foliage and impair photosynthesis (MD DNR, n.d.). Ozone levels as low as 40 to 60 parts per billion have been shown to be harmful to sensitive plant species (Stormcenter Communications, Inc., 2003).

Construction activities

During construction, trees can be damaged by soil compaction, grade changes, root crushing and pruning, damage to the bark, improper pruning of branches, incorrect storage of construction material, and dumping of construction wastes (PSU, 1999; Figure 6). Even if the tree does not appear to be physically harmed, underground root damage may kill the tree later on, which is why protecting the root zone is so important. Some trees will decline slowly over a number of years after construction damage occurs, while others may die quickly. An indirect impact to trees from construction activities results from changing conditions when exterior or interior trees are removed from a group of trees. Trees growing in groups are adapted to each other and to their light, wind, and soil conditions. After a removal, the remaining trees are subject to windthrow, sunscald, and altered soil conditions.

Physical damage from lawnmowers, vandalism, or vehicles

Damage to trees caused by mowers is common, particularly where turf is planted around trees. Vandalism may be common in highly urban areas. Damage to trees from vandalism was found to be highest in areas of high child use, such as playgrounds, or near pubs and bars (Foster, 1978). This same study found that the most common injury to curbside trees was caused by automobiles. Autos may damage 81%



Figure 5. A typical urban tree pit is about 4 feet by 4 feet and does not provide adequate soil volume for most trees.



Figure 6. Improper disposal of construction materials and inadequate protection negatively impact trees at a construction site.



Figure 7. Deer browsing damages seedlings.



Figure 8. Urban heat island effect—Because this tree is surrounded by pavement, it is exposed to high temperatures.

of sidewalk trees in a business area, particularly those located near the curb (Foster, 1978). Injury leads to fungal decay, which can kill a tree.

Damage from insects or animals

Damage to trees from deer overbrowsing is common in urban or suburban areas where deer populations are uncontrolled (Figure 7). Where beavers are present, they may cut down many trees in urban riparian areas to build dams. Rodents and other animals may chew on bark, effectively girdling a tree. Poor planting conditions and other urban stressors can make urban trees more susceptible to disease and to pests such as insects.

Soil compaction from heavy foot traffic

Heavy foot traffic in tree planting areas can compact soils, and limit soil drainage and root growth. Street trees are particularly susceptible to trampling damage if appropriate measures are not taken to restrict foot traffic over tree roots.

Exposure to pollutants in storm water runoff

Urban storm water runoff can contain moderate to high levels of pollutants such as salt and other de-icers, metals, bacteria, pesticides, and nutrients. Many tree species cannot tolerate elevated levels of these constituents.

Soil moisture extremes

Paved surfaces are engineered to quickly shed water, often in directions that either deprive trees of adequate soil moisture or leave their roots submerged in excess water (Appleton and others, 2002). An increase in impervious surfaces has also been linked to a decline in baseflow and groundwater (CWP, 2003), which further reduces available water for trees. Poor soil drainage, clogged drainage systems, lack of proper tree maintenance, and significant variation in properties of rootball soil, backfill soil, and site soil can also contribute to soil moisture extremes (Hammerschlag and Sherald, 1985). Damage to

trees from flooding and drought is most pronounced during the growing season and includes decline in tree growth, disruption of food production, and poor nutrient uptake (Coder 1994, 1999).

Exposure to wind and high temperatures

Urban trees are often planted in the open and lack protection. Increased exposure to wind affects tree stability and increases susceptibility to drought. Air temperatures in urban areas are generally higher than those in non-urban areas due to the urban heat island effect (Figure 8). Urban trees also have increased exposure to solar radiation when planted alone because they receive sunlight from all sides. Urban trees are exposed to lighting at night, which further increases temperature.

Competition from invasive plant species

Invasive plants are common in disturbed urban areas, such as roadsides and riparian areas, and can outcompete desirable trees by using up already limited water and nutrients.

Improper planting and maintenance techniques

Improper planting and maintenance techniques or lack of maintenance can damage or even kill a tree. For example, improper pruning techniques can make trees more susceptible to disease and pests. Improper use of stakes can also cause tree damage or death.



Figure 9. A common infrastructure conflict results in tree roots lifting or cracking pavement due to inadequate setbacks between trees and pavement.

Photo: Edward F. Gillman

Conflicts with infrastructure

When trees come in contact with pavement or utilities, they can cause damage such as downed powerlines, sidewalk cracking (Figure 9), and heaving or clogged sewer pipes. Preventative or remedial measures to correct such damage may injure the tree or cause the offending tree to be removed.

Disease

Poor planting conditions and other urban impacts place urban trees under stress and can make them more susceptible to disease and to pests such as insects.

In addition to the above-mentioned constraints of urban environments, planting trees in STPs presents a unique set of considerations, such as increased exposure to urban pollutants and frequent and extended inundation. These conditions are described and addressed further in Chapter 3. Part 3 of this manual series provides additional detail on identifying and addressing limitations of specific planting environments.

Chapter 2. How to Conserve and Plant Trees at Development Sites

This chapter describes in detail the steps that can be taken to conserve existing trees during construction and to plant trees at development sites.

Conserving Existing Trees During Construction

The preferred method for increasing tree cover at a development site is to conserve existing trees during construction, particularly where mature trees are present. Existing trees are conserved during construction through a five-step process:

1. Inventory existing forest.
2. Identify trees to protect.
3. Design the development with tree conservation in mind.
4. Protect trees and soil during construction.
5. Protect trees after construction.

More guidance on conserving trees at development sites can be found in MN DNR (2000), Greenfeld and others (1991), PSU (1999), and Johnson (2005).

1. Inventory Existing Forest

A natural resource professional such as a forester or arborist should conduct an inventory of existing trees and forested areas at the development site before any site design, clearing, or construction takes place. Some communities may require a forest inventory, while it may be optional in others. The extent of the inventory will depend on local regulations, lot size, vegetative cover, and the extent of development activity. In some cases, the inventory may survey each individual tree, while in others, it may entail a limited sampling of forest stands. Tree preservation ordinances will often dictate the size and types of trees that must be inventoried.

The inventory begins with a site map that includes legal, infrastructure, physical, ecological, cultural, and historical features listed in Box 4.

BOX 4. MAPPING DATA FOR FOREST INVENTORY

- Property boundaries
- Roads
- Utilities
- Easements and covenants
- Topography
- Streams
- Soils
- Steep slopes
- Stream buffers
- Critical habitats
- Adjacent land uses
- Cultural and historical sites
- 100-year floodplains
- Non-tidal wetlands

Chapter 2: How to Conserve and Plant Trees

The next step in the inventory is to survey existing trees and determine their species, condition, and ecological value. Locations of trees and forest stands are marked on maps, along with sampling points, and tree and forest health data are recorded on appropriate field sheets.

The State of Maryland is unique in that it requires an inventory of existing forest at certain development sites under the Forest Conservation Act (Box 5). This inventory, called the Forest Stand Delineation (FSD), is used to characterize and map the existing forest on a development site. The FSD results in a map of existing forest, a site vicinity map, forest stand summary sheets, and a narrative of forest stand conditions.

The site inventory process required in Maryland provides a useful model for evaluating forest conservation priorities at development sites elsewhere. Additional guidance on other methods to inventory existing forest conditions is presented in Table 6. Figure 10 presents a typical FSD map, while copies of FSD forms and field methods are provided in Appendix A.

BOX 5. MARYLAND'S FOREST CONSERVATION ACT

The Forest Conservation Act of 1991 was enacted to protect the forests of Maryland by making the identification and protection of forests and other sensitive areas an integral part of the site planning process. The Act provides guidelines for the amount of forested land retained or planted after the completion of development projects. These guidelines vary for each development site and are based on land-use categories. Where little or no forest exists, the Conservation Act requires that new forests be established by planting trees.

To meet these requirements, information on the condition of the existing forest and a plan for conserving the most valuable portions of the forest are required. Therefore, a qualified resource professional must conduct a Forest Stand Delineation (FSD) and create a forest conservation plan for all development disturbing more than 40,000 square feet.

Table 6. Forest and Tree Inventory Guidance

| Forest Inventory Method/Guidance | Applicability | Source |
|---|--|-----------------------------|
| Maryland Forest Stand Delineation | Method used to delineate and characterize forests on a development site | Greenfeld and others (1991) |
| Trees Approved Technical Manual | Methods for natural resources inventory and forest stand delineation used in Montgomery County, MD | MNCPPC (1992) |
| Volunteer Training Manual | Method used to inventory and evaluate the health of street trees | USDA Forest Service (1998) |
| A Guide to Preserving Trees in Development Projects | Provides guidance for conducting a tree inventory at a development site | PSU (1999) |
| Conducting a Street Tree Inventory | Method used to inventory and evaluate the health of street trees | Cornell University (2004) |
| Conserving Wooded Areas in Developing Communities | Provides guidance for conducting a natural resources assessment at the landscape, subdivision, and lot level | MN DNR (2000) |

Urban Watershed Forestry Manual - Part 2

The inventory of existing forest has three goals: to comply with local tree preservation or other ordinances, to identify the highest quality trees and forest stands on the site for protection, and to identify and address problems such as invasive species and pest or disease outbreaks. The field assessment portion of the inventory typically collects basic information about the tree species, size, and age, as well as the condition of individual trees and suitability for preservation of forest stands.

If the site contains large forest stands, sample individual points at a sampling intensity sufficient to characterize the entire stand. Select sampling site locations at random and draw them on the map before going to the site, and then flag them in the field. Specific forest stand information collected may include dominant species and forest association, size class of dominant trees, total number of tree species, number of trees per acre, common understory trees, and a forest structure rating. Appendix A contains forest stand summary sheets and methods for calculating forest structure rating from the Maryland FSD.

The results of the forest inventory should be provided to site engineers and landscape architects before site design and layout.

2. Identify Trees to Protect

The forest inventory identifies priority trees or forest stands to conserve and protect during site development. Trees and forest identified for protection should include the minimum needed to comply with local tree preservation regulations and trees located within easements, covenants, or other protected areas. Additional selection criteria include tree species, size, condition, and location (Table 7). Greenfeld and others (1991) provide additional guidance on prioritizing forest areas to retain during development.

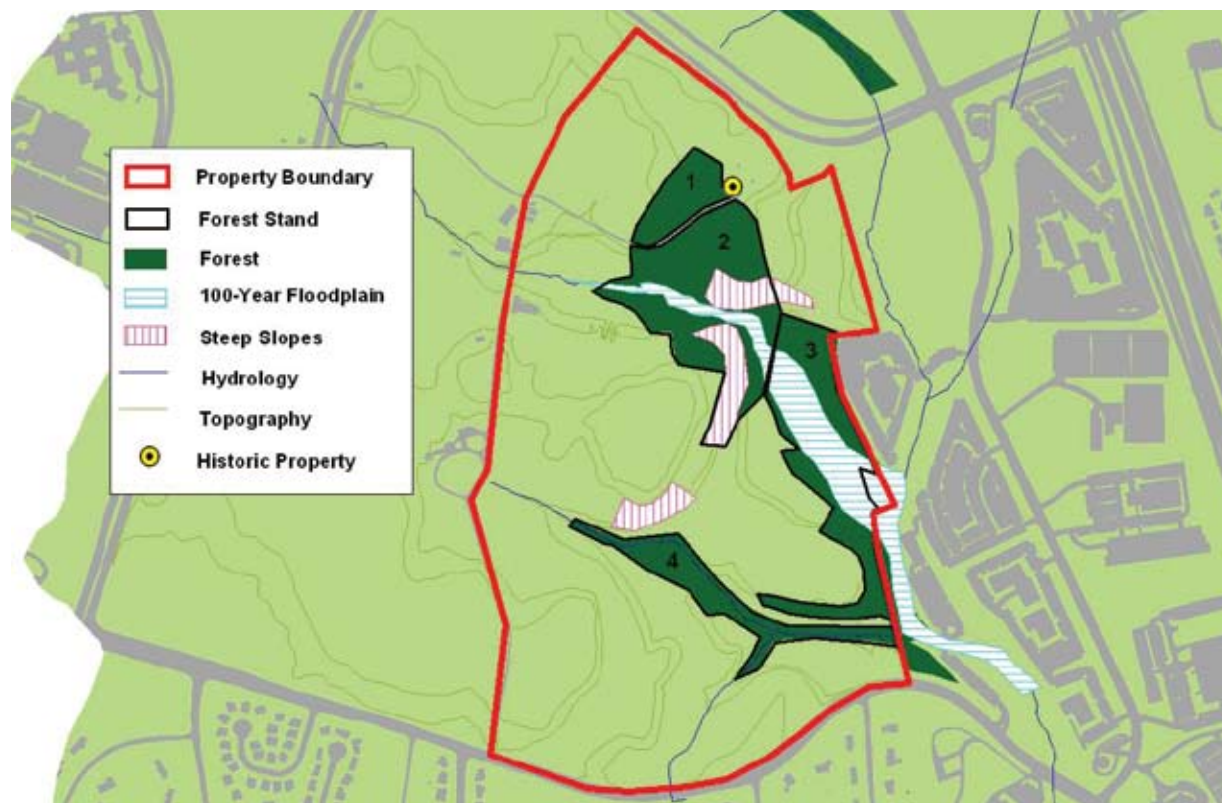

Figure 10. A map of existing forests on a development site is one product of Forest Stand Delineation—a required inventory in the State of Maryland.

| Table 7. Selecting Priority Trees and Forests for Conservation | |
|--|---|
| Selection Criteria for Tree Conservation | Examples of Priority Trees and Forests to Conserve |
| Species | Rare, threatened, or endangered species Specimen trees High quality tree species (e.g., white oaks and sycamores because they are structurally strong and live longer than trees such as silver maple and cottonwood) Desirable landscaping species (e.g., dogwood, redbud, serviceberry) Species that are tolerant of specific site conditions and soils |
| Size | Trees over a specified diameter at breast height (d.b.h.) or other size measurement Trees designated as national, state, or local champions Contiguous forest stands of a specified minimum area |
| Condition | Healthy trees that do not pose any safety hazards High quality forest stands with high forest structural diversity |
| Location | Trees located where they will provide direct benefits at the site (e.g., shading, privacy, windbreak, buffer from adjacent land use) Forest stands that are connected to off-site forests that create wildlife habitat and corridors Trees that are located in protected natural areas such as floodplains, stream buffers, wetlands, erodible soils, critical habitat areas, and steep slopes. Forest stands that are connected to off-site nonforested natural areas or protected land (e.g., has potential to provide wildlife habitat) |

Trees and forests selected for protection should be clearly marked both on construction drawings and at the actual site. Flagging or fencing are typically used to protect trees at the construction site. Areas of trees to save should be marked on the site map and walked during preconstruction meetings.

If it is not feasible to conserve all of the desired trees at a site, one option to consider is transplanting some of the trees to another location on the site. Transplanting should be done by a licensed arborist or natural resource professional and may be done with equipment that is already available at the site. Guidance on transplanting trees is provided in Bassuk and others (2003).

3. Design the Development With Tree Conservation in Mind

Once trees and forests are identified for protection, the layout of the site should be designed to conserve these areas, using:

- Open space design techniques to minimize impervious cover and conserve a larger proportion of forest
- Site fingerprinting to minimize clearing and land disturbance
- Setbacks from the critical root zone of trees to be conserved.

Urban Watershed Forestry Manual - Part 2

Developments should be designed to conserve the maximum amount of forest possible by locating buildings and roads away from priority forest conservation areas and by reducing the total area of graded surfaces. One technique that both reduces grading and conserves forested areas is open space design. Also known as cluster development, open space design is a compact form of development that concentrates density on one portion of the site by clustering lots in exchange for reduced density elsewhere (Figure 11). Minimum lot sizes, setbacks, and frontage distances are relaxed to provide conservation of natural areas such as forests. Open space developments cost less to build because of reduced clearing, paving, storm water management, and infrastructure costs. Open space subdivisions can also bring in higher premiums since people will typically pay more to have a wooded lot or live next to a natural area (see Chapter 1). Open space designs reduce impervious cover by 40% to 60%, thereby conserving significant portions of forest on a site (Schueler, 1995). More guidance on open space design can be found in Schueler (1995), CWP (1998), and Arendt (1996).

Site designers should be creative. For example, houses do not always have to be located in the center of the lot, and the design can take advantage of trees and forests for window views and focus of outdoor decks and recreational spaces. If open space design is not allowed under existing local site development codes, other techniques can still be applied to reduce impervious cover (CWP, 1998). Some examples of Better Site Design techniques to reduce impervious cover and maximize conservation potential are listed in Box 6.

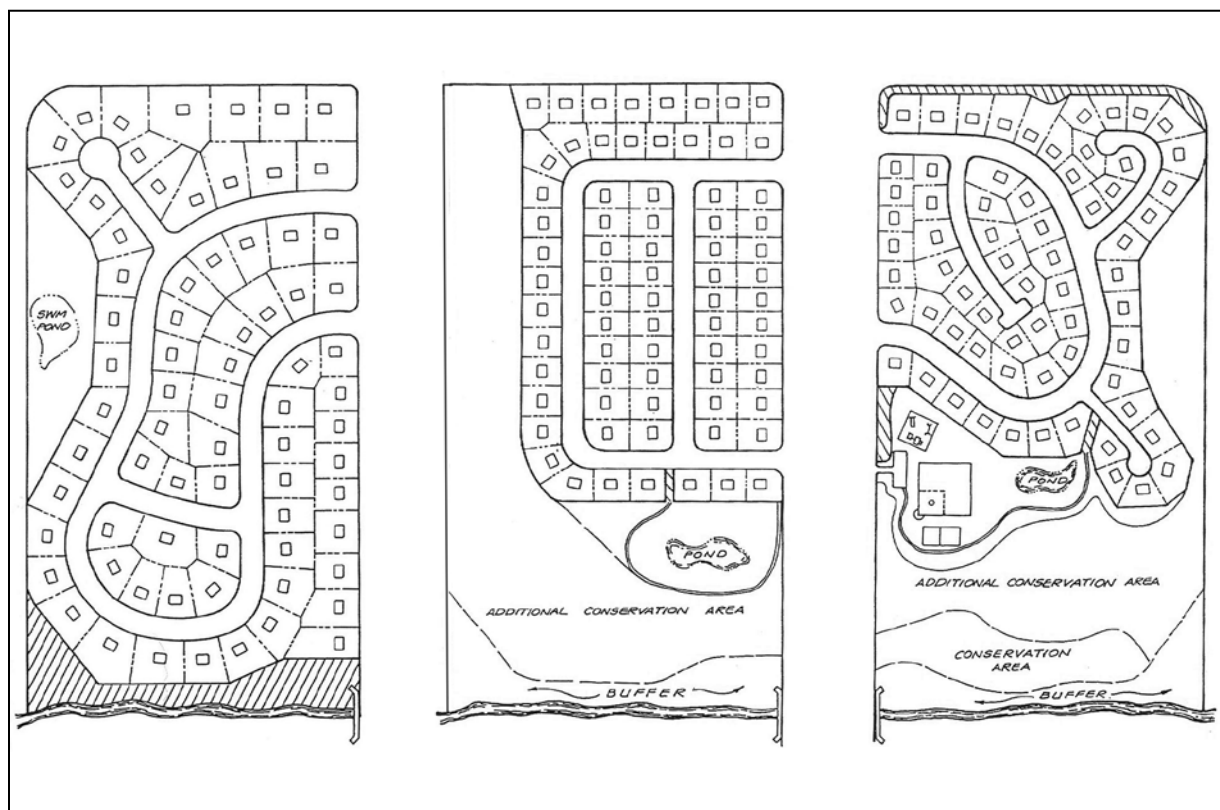

Figure 11. An open space design with 72 lots (center) uses less land than a conventional subdivision with the same number of lots (left). Floodplains and wetlands (hatched lines) are considered unbuildable and must be subtracted from gross density. An alternative design (right) provides 66 lots. (Source: Schueler, 1995, p. 57-58)

BOX 6. BETTER SITE DESIGN TECHNIQUES TO CONSERVE FORESTS

- Design structural elements such as roads and utilities to minimize soil disturbance and take advantage of natural drainage patterns.
- Where possible, place several utilities in one trench in order to minimize soil disturbance.
- Reduce building footprints by building up, not out.
- Use the minimum required street and right-of-way widths.
- Use alternative turnarounds instead of cul-de-sacs.
- Use efficient street layouts.
- Consider shared driveways for residential lots.
- Use the minimum required number of parking spaces instead of creating additional spaces.

Another method to conserve forests during site design is called site fingerprinting. Also known as site footprinting, site fingerprinting minimizes the amount of clearing and grading conducted at a site by limiting disturbance to the minimum area needed to construct buildings and roadways (Figure 12). A suggested limit of disturbance (LOD) around structures is 5 to 10 feet outward from the building pad (Greenfeld and others, 1991). No clearing, grading, or siting and construction of utility lines, access roads, staging, storage or temporary parking areas, storm water management practices or impervious surfaces should be located within the LOD. This requires that designated areas for temporary parking, material storage, and construction spoil, and holding areas for vegetation and topsoil be established outside the LOD. Designing the site to have only one access point, which coincides with planned roadways, driveways, or utilities also limits the amount of clearing necessary. The LOD should be clearly marked both on site plans and at the site.

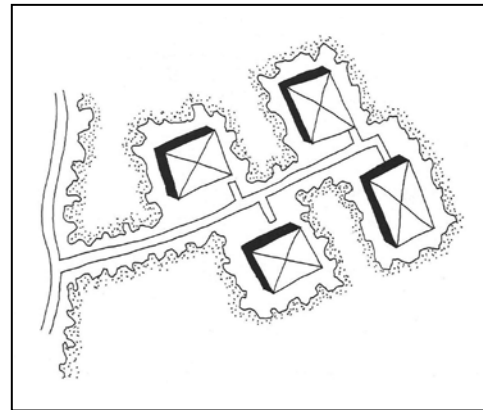

Figure 12. Site fingerprinting limits site disturbance to the minimum necessary for building. (Source: Greenfeld and others, 1991, p. 51)

The LOD should incorporate a field delineation of the critical root zone (CRZ) for trees to be conserved. The CRZ, also called the protected root zone, is a circular region measured outward from a tree trunk representing the essential area of the roots that must be maintained or protected for the tree's survival (Greenfeld and others, 1991). In order to adequately protect the tree, no disturbance should occur within the CRZ. There are four methods for delineating the critical root zone:

1. *Trunk diameter method* – Measure the tree diameter in inches at breast height (54 inches above the ground). For every inch of tree diameter, the CRZ is 1 foot of radial distance from the trunk, or 1.5 feet for specimen or more sensitive trees (Greenfeld and others, 1991; Coder, 1995). Figure 13 illustrates the trunk diameter method.
2. *Site occupancy method* – Predict the tree diameter at breast height in inches for that tree at 10 years old. Multiply the number by 2.25 and convert the result into feet to obtain the radius of the CRZ (Coder, 1995).

Urban Watershed Forestry Manual - Part 2

3. *Minimum area method* – Protect an area of approximately 6 feet in radius around the trunk of the tree as the CRZ (MN DNR, 2000).
4. *Dripline method* – Measure the distance of the branch that extends horizontally farthest from the trunk and multiply by 1.5 to obtain the CRZ radius. Another option is to project the dripline downward to the ground and delineate the area beneath the tree branches or crown as the CRZ (MN DNR, 2000).

The natural resource professional should select the method of delineation. In general, the trunk diameter method is best for trees growing in a forest or with a narrow growth habitat, the minimum area method is preferred for very young trees, and the dripline method is preferred for protecting mature open-growing trees (MN DNR, 2000). These methods do not protect the tree's entire root system but represent a good compromise between tree survival or growth and available space. Other considerations when delineating protected root zone include the following (Greenfeld and others, 1991):

- *Species sensitivity* – Certain species are more tolerant to disturbance or compaction than others. For sensitive species, delineate the CRZ based on species and site evaluation.
- *Tree age* – Younger trees are generally more tolerant of disturbance than older ones. For mature trees, delineate a slightly larger CRZ.

4. Protect Trees and Soil During Construction

Physical barriers must be properly installed around the LOD to protect trees to be conserved and their associated CRZ. The barriers should be maintained and enforced throughout the construction process. Tree protection barriers include highly visible, well-anchored temporary protection devices, such as 4-foot fencing, blaze orange plastic mesh fencing (see Figure 14), two- to three-strand barbed wire fence, or snow fencing (Figure 15) (Greenfeld and others, 1991). Specifications for tree protection methods are provided in Appendix B.

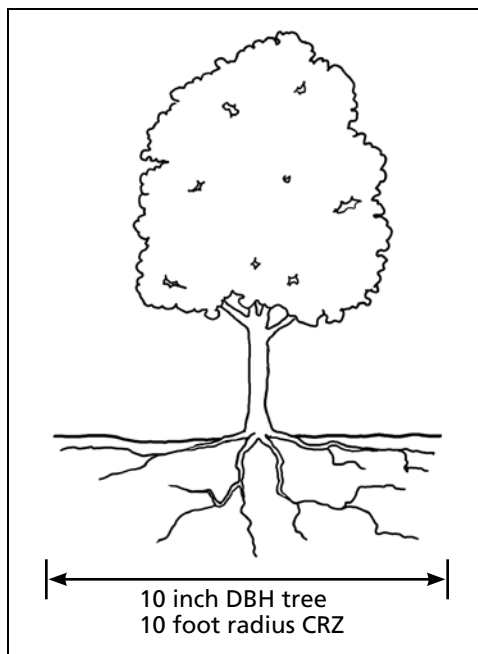

Figure 13. The trunk diameter method is one of four ways to define the critical root zone (CRZ). (Source: Greenfeld and others, 1991, p. 62)



Figure 14. Orange plastic mesh fencing delineates tree protection areas.

Chapter 2: How to Conserve and Plant Trees

All fencing should have highly visible flags and include posted signs clearly identifying the tree protection area. No equipment, machinery, vehicles, materials, excessive pedestrian traffic, or trenching for utilities should be allowed within protection areas. It may be necessary to install temporary drainage and irrigation for trees and other plants to be preserved.

All protection devices should remain in place throughout construction, and penalties for violation should be enforced. A landscape protection contract signed by the builder, developer, contractor, and all subcontractors will help ensure compliance.

Tree conservation begins by preserving the native soils throughout the site, especially in areas that will be used for planting. Soil stockpiling and mulching can be used to protect the infiltration capacity of these native soils. Soil stockpiling is the temporary storage of topsoil that has been excavated from a construction site. This soil is then reused on the site in planting areas to provide a higher quality growing medium for new vegetation, which also saves the builder from having to purchase and haul in new topsoil. Applying a layer of mulch at least 6 inches thick over areas that will be used for traffic or material storage during construction also helps to prevent soil compaction in areas that will be used for future planting of trees and other vegetation.



Figure 15. Fencing surrounds a mature tree that is to be preserved.

5. Protect Trees After Construction

Developers should educate both current and new residents about the existence and benefits of trees in their development. Developers should ensure that a responsible entity is created to maintain forest conservation areas and enforce their boundaries. Some methods used to educate residents include posting of signs and constructing fences to serve as boundary markers; use of covenants that define homeowners' associations (HOA) as being responsible for maintenance of trees; enforcement mechanisms to protect forests from encroachment; and incorporating individual tree maintenance agreements into real estate plats and deeds.

HOAs can distribute pamphlets and other educational materials about the benefits and location of protected forests in their neighborhoods; inform residents of forest protection policies at HOA meetings; organize urban forest walks or inspections to monitor the condition of the urban forest and to search for pests and invasive species; and organize planting days to engage residents in tree planting. HOAs can also enforce forest protection policies by inspecting forest conservation areas and mailing correction notices requiring reforestation or other measures, depending on the type of violation. As a last resort, civil fines can be used if notices do not result in cooperation.

Local governments also play an important role in protecting forests after construction by ensuring that appropriate ordinances are enforced to adequately protect forest conservation areas. For example, a community's open space design or forest conservation ordinance should provide specific criteria for the long-term protection and maintenance of natural areas (e.g., restrictions on tree clearing except for safety reasons), and should establish appropriate enforcement measures. A third party, such as a local land trust, may be designated responsible to hold and manage forest conservation easements. Land trusts are effective groups to monitor the site and enforce its boundaries, and the third party land trust option should be specifically allowed in the local ordinance. Model ordinances for open space design and tree protection are provided at the links below:

- Open Space Design Model Ordinance:
www.stormwatercenter.net/Model%20Ordinances/open_space_model_ordinance.htm
- Forest Conservation Ordinance from Frederick County, MD:
www.stormwatercenter.net/Model%20Ordinances/misc_forest_conservation.htm

Planting Trees at Development Sites

New development sites provide many opportunities to plant new trees, such as in STPs, along local roads, and in parking lots. While some STPs are not traditionally considered appropriate for tree planting, planting trees and shrubs in certain areas of specific STPs can enhance their attractiveness and improve their performance. Planting trees at new development sites is done in three steps:

1. Select planting sites.
2. Evaluate and improve planting sites.
3. Plant and maintain trees.

1. Select Planting Sites

Potential planting sites in a new development or redevelopment site include portions of local road rights-of-way, such as buffer areas, islands and median strips, parking lot interiors and perimeters,

and certain types of storm water treatment practices (Figure 16). In many communities, some type of landscaping is required in and around parking lots and along residential streets. As such, the developer may have to meet these requirements anyway. Other areas of a development site that may be a priority for planting trees include stream valleys and floodplains, areas adjacent to existing forest, steep slopes, and portions of the site where trees would provide buffers, screening, noise reduction, or shading.

2. Evaluate and Improve Planting Sites

It is important to evaluate and record the conditions at proposed planting sites to ensure they are suitable for planting, select the appropriate species, and determine if any special site preparation techniques are needed. A method for evaluating urban tree planting sites is The Urban Reforestation Site Assessment (URSA). Box 7 lists the factors evaluated using the URSA, while Part 3 of this manual series contains the full field form and accompanying guidance for completing it.

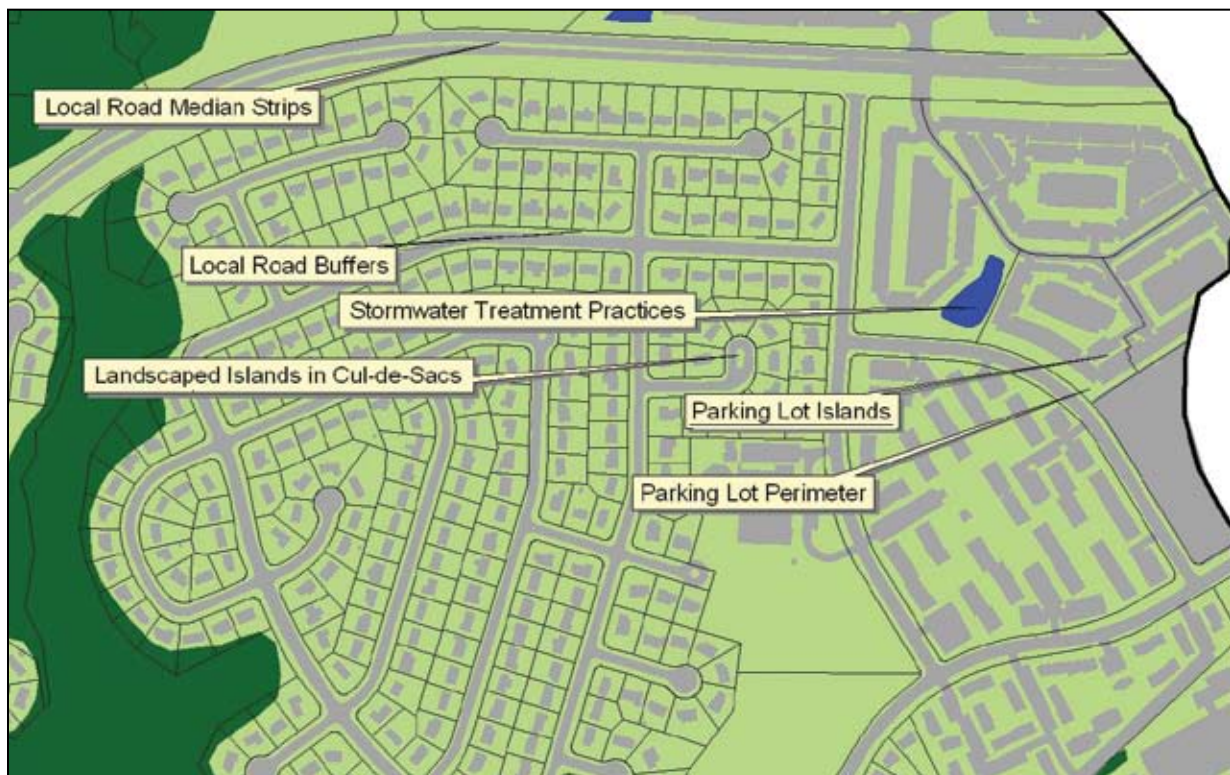

Figure 16. Development sites offer several potential planting areas.

BOX 7. FACTORS ASSESSED DURING THE URBAN REFORESTATION SITE ASSESSMENT

- General site information
- Climate
- Topography
- Vegetation
- Soils
- Hydrology
- Potential planting conflicts
- Planting and maintenance logistics
- Site sketch

Urban Watershed Forestry Manual - Part 2

Site characteristics determine what tree species will flourish there and whether any of the conditions, such as soils, can be improved through the addition of compost or other amendments. Improvements to the planting site generally apply only to smaller spaces. Therefore, when reforesting large tracts of land, it is probably not feasible from a cost and labor standpoint to apply soil amendments over the entire planting area. Table 8 presents methods for addressing common constraints to urban tree planting. Part 3 of this manual series provides more detail on each method.

In general, the best way to address urban planting constraints is to ensure each planting project meets the design principles in Box 8, which are adapted from Urban (1999) and GFC (2001).

| Table 8. Methods for Addressing Urban Planting Constraints | |
|--|--|
| Potential Impact | Potential Resolution |
| Limited soil volume | Use planting arrangements that allow shared rooting space Provide at least 400 cubic feet of soil per tree |
| Poor soil quality | Test soil and perform appropriate restoration Select species tolerant of soil pH, compaction, drainage, etc. Replace very poor soils if necessary |
| Air pollution | Select species tolerant of air pollutants |
| Damage from lawnmowers | Use mulch or tree shelters to protect trees |
| Soil compaction from heavy foot traffic | Use mulch to protect trees Plant trees in low-traffic areas |
| Damage from vandalism | Use tree cages or benches to protect trees Select species with inconspicuous bark or thorns Install lighting nearby to discourage vandalism |
| Damage from vehicles | Provide adequate setbacks between vehicle parking stalls and trees |
| Damage from animals such as deer, rodents, rabbits, and other herbivores | Use tree shelters, protective fencing, or chemical retardants |
| Exposure to pollutants in storm water and snowmelt runoff | Select species that are tolerant of specific pollutants, such as salt and metals |
| Soil moisture extremes | Select species that are tolerant of inundation or drought Install underdrains if necessary Select appropriate backfill soil and mix thoroughly with site soil Improve soil drainage with amendments and tillage if needed |
| Increased temperature | Select drought tolerant species |
| Increased wind | Select drought tolerant species |
| Abundant populations of invasive species | Control invasive species prior to planting Continually monitor for and remove invasive species |
| Conflict with infrastructure | Design the site to keep trees and infrastructure separate Provide appropriate setbacks from infrastructure Select appropriate species for planting near infrastructure Use alternative materials to reduce conflict |
| Disease or insect infestation | Select resistant species |

BOX 8. DESIGN PRINCIPLES FOR URBAN TREE PLANTING

Adapted from Urban (1999) and GFC (2001)

Provide adequate soil volume to support the tree at maturity. A general guideline is to provide 2 cubic feet of usable soil for every square foot of mature canopy. Design soil volumes of planting areas to be interconnected so trees can share rooting space.

Preserve and improve soil quality. Limit use of heavy equipment in planting areas to protect native soils from compaction. Soil volume should be accessible to air, water, and nutrients. This is best achieved by separating paving from the tree's rooting area, which also allows for periodic inspection of the planting area. Soils should be amended if necessary to improve drainage and fertility.

Provide adequate space for tree to grow. Design surrounding infrastructure to accommodate long-term growth of tree. Space trees to allow for long-term growth and management, including thinning and replacement of the stand.

Select trees for diversity and site suitability. Plant a variety of species that are tolerant of the climate and soil conditions as well as any urban impacts at the site.

Protect trees from other impacts. Develop designs that protect the tree over its entire life from pedestrian traffic, toxic runoff, high temperatures, and other urban impacts.

Part 3 of this manual series provides guidance on tree species selection in the form of an Urban Tree Selection Guide. A useful source for tree selection is the USDA PLANTS database, which can be accessed at <http://plants.usda.gov>.

3. Plant and Maintain Trees

Planting trees at new development sites requires prudent species selection, design modifications, a maintenance plan, and careful planning to avoid impacts from nearby infrastructure, runoff, vehicles or other urban elements. Chapter 3 provides specific guidance on planting trees in various storm water treatment practices—storm water wetlands, swales, bioretention and bioinfiltration facilities, and filter strips.

Chapter 4 provides specific guidance for planting trees at development sites in pervious areas along local roads and in parking lots.

Part 3 of this manual series provides additional detail on tree planting, site preparation, and maintenance techniques.

Chapter 3. Design and Planting Guidelines for Storm Water Forestry Practices

This chapter provides detailed guidance for planting trees in storm water treatment practices (STPs), known as storm water forestry practices (SFPs). Guidelines are presented with conceptual designs for the following SFPs:

- Wooded wetland
- Bioretention and bioinfiltration facilities
- Alternating side slope plantings (swale)
- Tree check dams (swale)
- Forested filter strip
- Multi-zone filter strip
- Linear storm water tree pit.

The SFP concept designs presented in this chapter are graphical representations only and do not necessarily incorporate all of the items needed for the final design and engineering. Those will require additional testing, research, and analysis; and we welcome future additions to the designs presented here.

SFPs incorporate trees and shrubs into the design of storm water wetlands, swales, bioretention or bioinfiltration facilities, and filter strips. Alternatively, conventional tree pit designs can be modified to accept and treat storm water runoff, thereby functioning as an STP. Traditional landscaping guidance either does not allow or does not address planting trees in storm water practices (Figures 17 and 18). Despite the fact that tree planting is rare in STPs, there are many potential benefits to doing so. Research on rainfall interception, evapotranspiration, and pollutant uptake of trees indicate that trees in STPs could significantly increase the efficiency of the traditional practice designs (see Box 2 on page 4 for hydrologic and water quality benefits of trees). Median pollutant removal efficiencies for standard STPs are presented in Table 9.

| Storm Water Treatment Practice | Total Suspended Solids | Total Phosphorus | Soluble Phosphorus | Total Nitrogen | Nitrate + Nitrite |
|--------------------------------|------------------------|------------------|--------------------|----------------|-------------------|
| Storm Water Wetland | 76 | 49 | 36 | 30 | 67 |
| Bioretention Facility | N/A | 65 | N/A | 49 | 16 |
| Dry Swale | 93 | 83 | 70 | 92 | 90 |
| Filter Strip (150 foot width) | 84 | 40 | N/A | N/A | 20 |

N/A = not available

Sources: Winer (2000), Yu and others (1993)



Figure 17. Storm water ponds with trees incorporated offer benefits over a conventional storm water pond with no trees (left).



Figure 18. Swales with trees offer greater benefits than a swale with no trees (left).

The SFP designs presented in this chapter were developed during a series of design workshops attended by storm water engineers, foresters, arborists, and landscape architects. The goal of the workshops was to identify potential limitations to planting trees in STPs, both from an engineering perspective and from the standpoint of tree survival and health. The resulting SFP designs were intended to address these limitations through design modifications, species selection, or other methods.

To identify which species of trees and shrubs would be best suited to each STP, it was necessary to first identify the conditions within each practice. In addition to the typical urban planting constraints, STPs have other planting constraints that may limit tree growth (Table 10).

| Characteristic | Storm Water Treatment Practice | | | |
|--|--------------------------------|-------------------------------|-------------|--------------|
| | Storm Water Wetland | Bioretention, Bioinfiltration | Swale (dry) | Filter Strip |
| Extremely compacted soils (limited soil volume) | X | | X | |
| Exposure to high winds and high temperatures | X | | | |
| Exposure to inundation (frequency, duration and depth varies) | X | X | X | X |
| Loose, unconsolidated soils, high in organic matter, possibly anaerobic | X | X | | |
| Ice damage and scour | X | | | |
| Potential for damage from mowers | X | | X | X |
| Competition from invasive species | X | | | |
| High chloride levels | | X | X | X |
| Exposure to high flows during storms (2-6 cubic feet per second) | | | X | X |
| Exposure to drought during dry periods | X | X | X | |
| May be used for snow storage | | X | X | X |
| Exposure to moderate to high levels of urban storm water pollutants (e.g., metals) | X | X | X | X |
| High sand content of soils (filter medium) | | X | X | |

Perhaps the most common planting constraint in STPs is periodic inundation or saturation of soils by storm water runoff. Table 11 provides details on the frequency, duration, and depth of inundation that trees and shrubs might be exposed to within each of the four groups of STPs. Figure 19 illustrates the four planting zones in storm water ponds and wetlands.

Many of the tree planting constraints within STPs listed in Table 10 can be addressed by selecting species that are tolerant of less than optimal conditions. In addition, species planted in STPs should be able to reduce storm water runoff (through rainfall interception and evapotranspiration) and mitigate pollutants commonly found in this runoff. Metro (2002) defined a list of characteristics of trees that best perform these functions. Based on this list and on the characteristics presented in Table 10, several desirable characteristics of trees to plant in STPs were defined (Box 9). Trees used in STPs should

| Inundation Characteristics ¹ | | Storm Water Treatment Practice | | | | | | |
|---|-------------------------------|--|---------|----------|---------|-------------------------------|-------------|--------------|
| | | Storm Water Pond and Wetland Planting Zones ² | | | | Bioretention, Bioinfiltration | Swale (dry) | Filter Strip |
| | | Zone I | Zone II | Zone III | Zone IV | | | |
| Frequency | Continuous | N/A | X | | | | | |
| | Frequent | | | X | | X | X | X |
| | Infrequent | | | | X | | | |
| Duration | Continuous | | X | | | | | |
| | Extended | | | X | X | | | |
| | Brief | | | | | X | X | X |
| Depth | < 6 inches | | | | | | | X |
| | 6-12 inches | | X | | | X | | |
| | Depends on planting elevation | | | X | X | | X | |

¹Frequent inundation = 10-50 times per year or more
 Infrequent inundation = a few times per year to once every 100 years
 Extended inundation = 2-3 days or more
 Brief inundation = a few to several hours

²See Figure 19 for an illustration of planting zones.

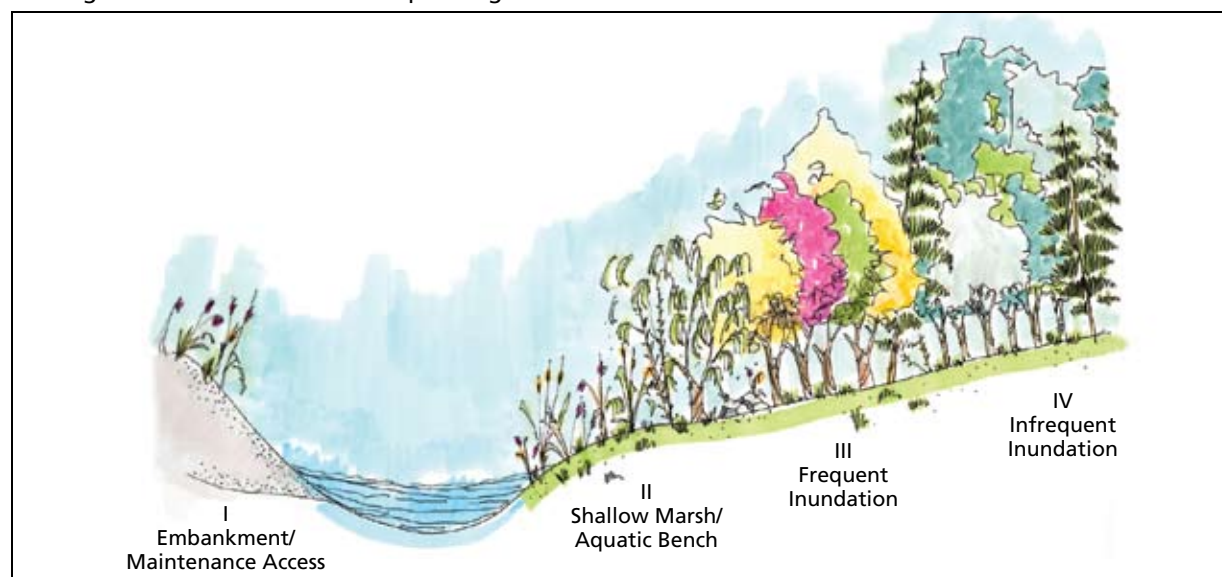

Figure 19. A storm water pond or wetland contains four planting zones.

have several of these characteristics. Additional detail on which tree characteristics are appropriate for specific SFPs is provided later in this chapter. Part 3 of this manual series provides further guidance on species selection.

Table 12 presents the potential engineering conflicts associated with trees in STPs that were identified during the design workshops, and some corresponding design methods to reduce or eliminate these conflicts. These engineering design methods have been incorporated into subsequent SFP concept designs in this chapter.

BOX 9. DESIRABLE CHARACTERISTICS OF TREES FOR STORM WATER TREATMENT PRACTICES

- Persistent foliage
- Wide-spreading, dense canopies
- Long-lived
- Fast growing
- Tolerant of drought
- Tolerant of inundation or saturated soils
- Resistant to urban pollutants (air and water)
- Tolerant of poor soils
- Extensive root systems
- Rough bark
- Tomentose or dull foliage surface
- Vertical branching structure

Table 12. Potential Engineering Conflicts and Resolutions, for Planting Trees in Storm Water Treatment Practices

| Potential Engineering Conflict | Resolutions |
|---|---|
| Tree litter may clog outlets and drainage pipes, increasing maintenance, and potentially drowning trees if not unclogged. | Use alternative outlet structures that do not clog. Select species that do not produce excessive litter. |
| It may be difficult to remove sediment from practices that require periodic sediment removal without harming or removing trees. | Modify practice design so that trees are separate from areas where sediment is deposited (e.g., use a forebay in a wetland). |
| Trees may shade out grass and contribute to erosion in practices with higher flows. | General consensus was that this should not be a concern. As a precaution, plant shade-tolerant ground covers where possible. |
| Tree roots may puncture filter fabric or underdrains. | Increasingly, designers are moving away from the use of filter fabric between the filter media and site soil, as it may create an undesirable soil-water interface. To replace the function of the filter fabric where needed, a sand or pea gravel layer may be used. Tree roots clogging or puncturing underdrains should not be a major concern. As a precaution, do not plant trees directly over underdrains. |
| Presence of trees in practice may reduce storage or conveyance capacity. | Modify practice design to account for trees (e.g., make it slightly larger). |
| Mowing around trees, where required, may be more difficult. | Cluster trees where possible to allow easier mowing. Cease mowing where it is not necessary and allow regeneration. Use meadow grasses that do not require frequent mowing (if appropriate for the region). |
| Overgrowth of trees in maintenance areas may limit access. | Limit trees in maintenance access areas and within 15 feet of these areas. |
| Trees on embankments may compromise stability. | Do not plant trees within 15 feet of embankment. |
| Trees with excessive fruits, nuts, and other litter may be nuisances, particularly adjacent to impervious surfaces. | Select species that do not produce excessive litter, particularly when planting near impervious surfaces. |

Urban Watershed Forestry Manual - Part 2

Seven concept designs for SFPs are presented in the remainder of this chapter in fact sheet format. These designs are graphical representations only and do not include all of the items needed for final design and engineering. Each fact sheet contains the following sections:

Description – brief description of practice, where it applies and benefits of incorporating trees.

Design Modifications – modifications to the standard STP to improve planting environment or reduce tree-engineering conflicts.

Species Selection – guidance on desirable species characteristics for planting trees and shrubs in the practice. Part 3 of this manual series includes an urban tree selection guide with tree species and their characteristics.

Planting Guidance – general and specific guidance on exactly how to incorporate trees into the practice.

Maintenance – recommended maintenance for tree-planting areas.

Topics for Future Research – unresolved issues or areas for further research or discussion.

Further Resources – resources for additional information.

This guidance on incorporating trees into STPs is provided as a better alternative either to having no trees at all or to allowing uncontrolled growth of volunteer species (Figure 20), which may conflict with the function of the practice and does not necessarily provide ideal habitat conditions.



Figure 20. Overgrowth of willows in this pond limits maintenance access and essentially creates a monoculture.

Wooded Wetland

Description

A wooded wetland is a variant of a standard storm water wetland design that provides detention and water quality treatment of storm water runoff. Most traditional storm water wetlands contain few, if any, large trees. The wooded wetland design incorporates trees and shrubs into planting zones II, III and IV shown in Figure 19 (page 26).

A wooded wetland is a fairly large practice and typically treats a minimum drainage area of 10 acres or more. This size makes it an ideal practice for highway cloverleaves, large residential subdivisions, and other large open areas such as parks and schools. The wooded wetland design is shown in Figure 21.

Planting trees in a storm water wetland can increase water use through evapotranspiration and may increase pollutant removal through nutrient uptake and biological soil processing. Additional benefits include habitat for wildlife, reduced mowing costs, shading of the permanent pool, deterrent of Canada geese, and bank stabilization.

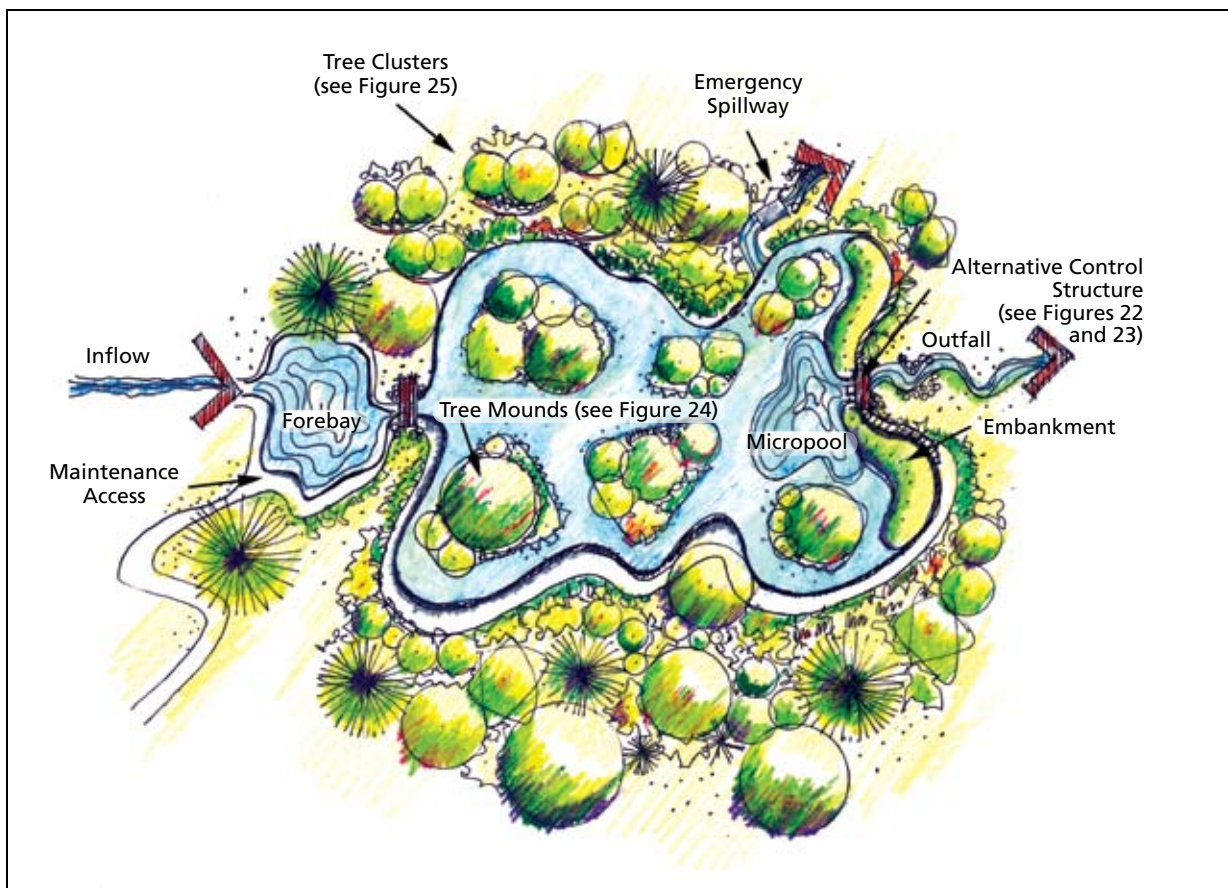

Figure 21. A wooded wetland incorporates trees into the design.

Wooded Wetland *Continued*

**Design
Modifications**

- Use an alternative control structure such as a weir with a v- or rectangular-notch and a hood to prevent clogging by woody debris (Figure 22). This control structure should be designed to address seepage and uplift on the weir wall, for example, by providing for seepage through the structure by using weep holes or by allowing sufficient travel distance along the base of the weir wall (so it behaves as an anti-seep collar). See USACE (1989) for additional guidance on floodwall and retaining wall design.
- Include measures to keep permanent pools at relatively safe elevations even when outlets clog. This alternative, used in Montgomery County, MD, incorporates perforated underdrains surrounded by stone along the face of each dam. The underdrains connect to flow restrictors within the embankment to ensure that the required flow controls are met. The designs also include a small (secondary) riser, which the underdrains and flow restrictors tie into (Figure 23). This secondary riser allows for a small amount of ponding if the underdrains become clogged. The resulting water surface elevation increase is relatively small and still allows for unclogging of underdrain flows without much problem.
- Use a forebay to trap sediment and allow for sediment removal without removing or injuring trees.

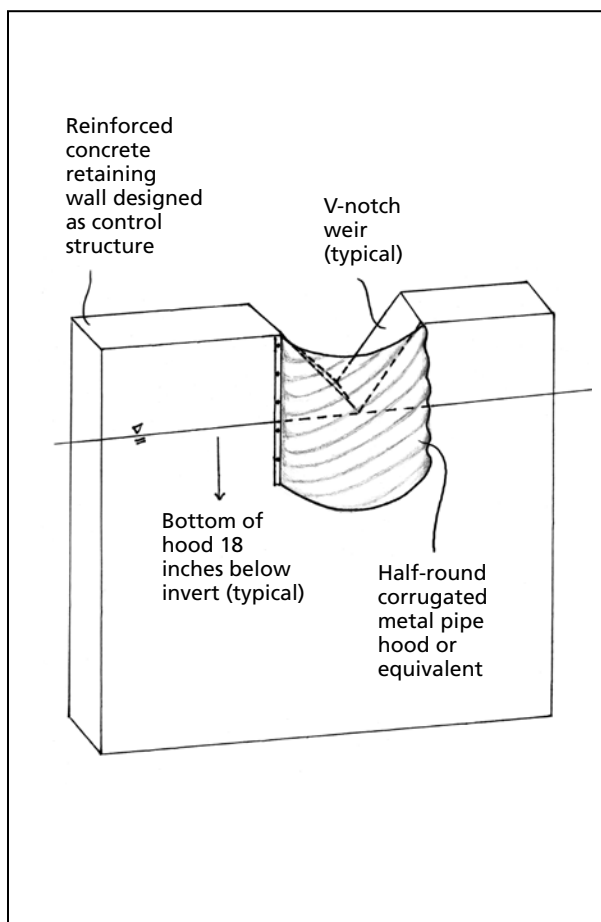

Figure 22. A weir wall with a v-notch and a hood resists clogging by woody debris.

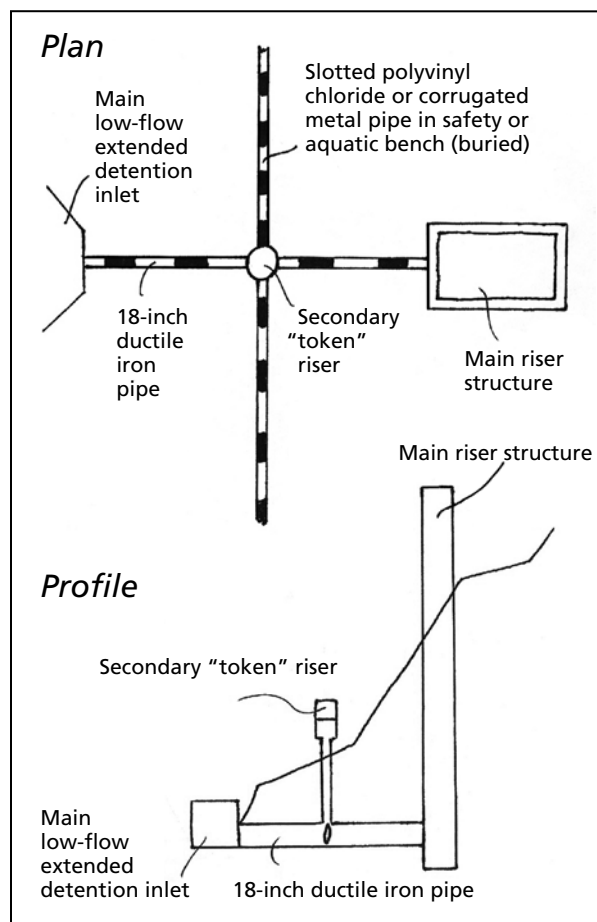

Figure 23. A secondary riser helps to keep permanent pools at safe elevations, even when outlets clog.

Species Selection

Species selection is key because most site conditions can be addressed by selecting appropriate tree species, rather than by trying to modify site conditions. Select a diverse mix of hardy, preferably native species (minimum of three), that are adapted to soils and site conditions.

Other desirable species characteristics include the following:

- Tolerant of compacted soils
- Tolerant of drought
- Tolerant of inundation
- Tolerant of urban pollutants

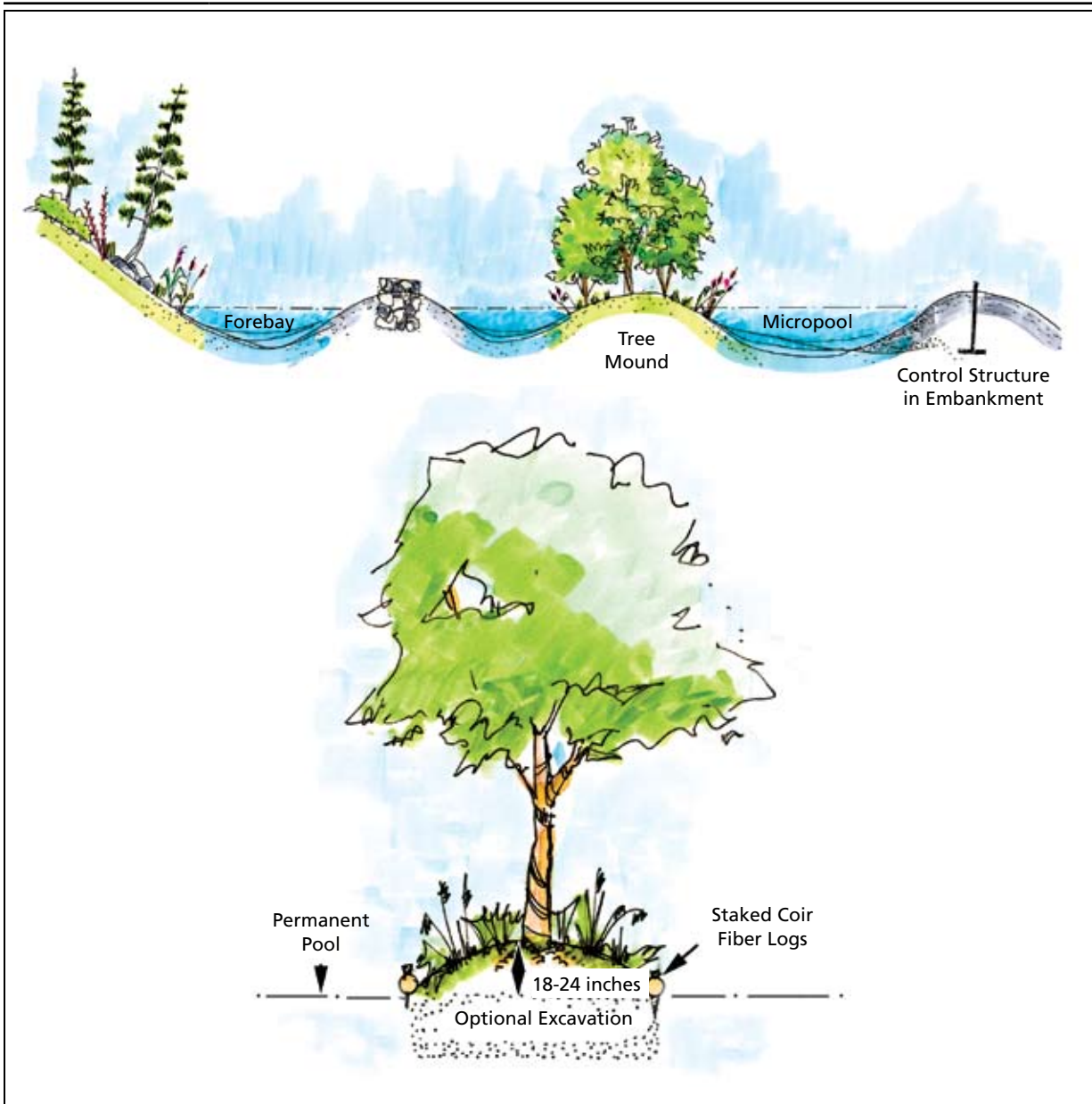

Figure 24. Tree mounds are one feature of a wooded wetland that incorporates trees.

Wooded Wetland *Continued*

**General
Planting
Guidance**

- Do not allow trees on embankment or in maintenance access area. Some small shrubs may be allowed (e.g., dogwoods or other “manageable” vegetation).
- Do not allow trees within 15 feet of embankment toe or maintenance access areas. Use a permanent pool to enforce this setback.
- Plant trees on mounds in shallow marsh area (Figure 24 on previous page).
- Plant trees in clusters on side slopes (Figure 25).

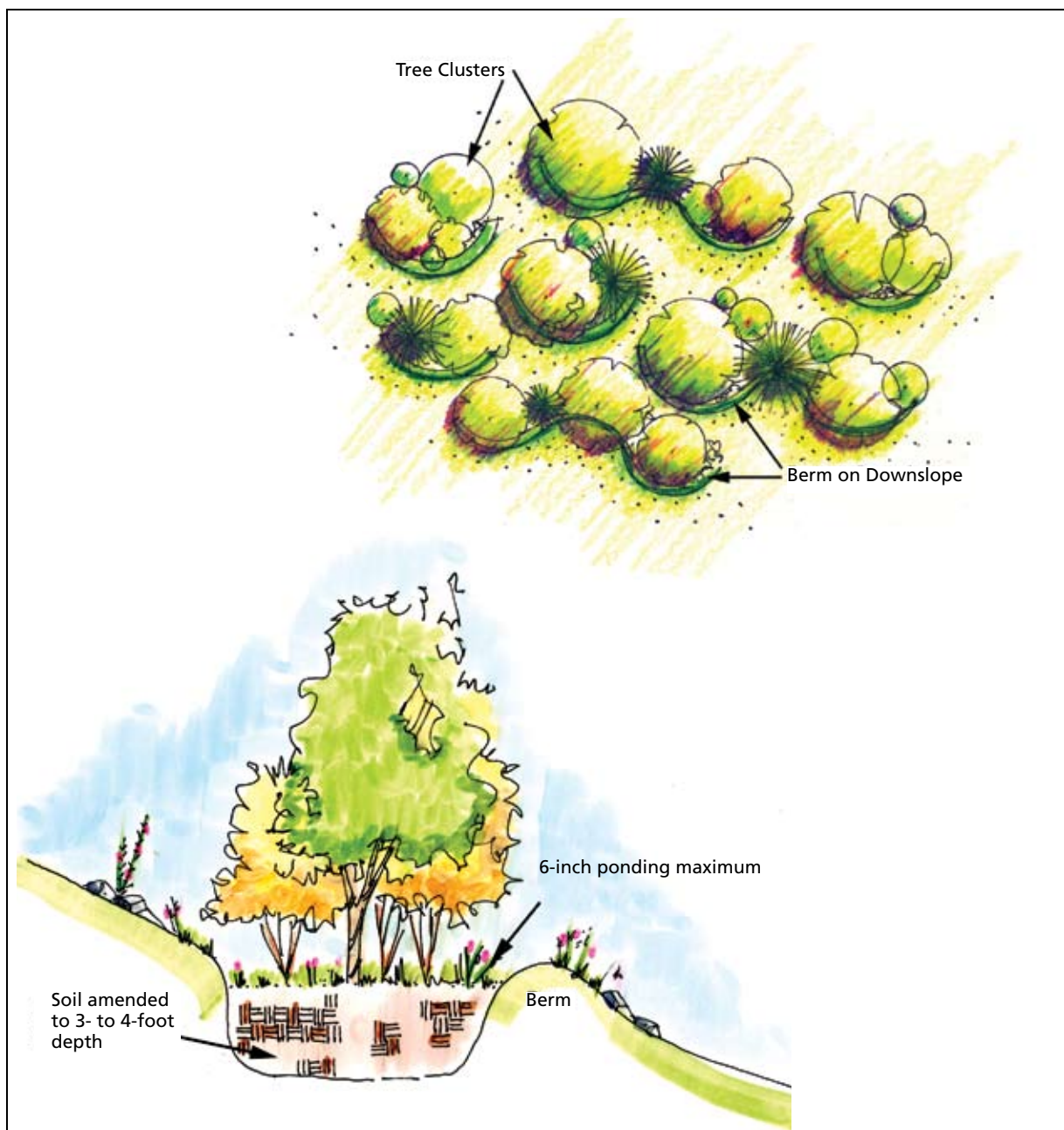

Figure 25. Tree clusters increase the soil and water volumes available for trees planted on side slopes.

**Specific
Planting
Guidance**

Tree Mounds

Tree mounds are islands located in the shallow marsh area of the wetland that are planted with trees (Figure 24). Mound placement should be such that a long internal flow path is created within the shallow marsh area. After initial wetland construction, mark boundaries of mound locations. Excavate the area of tree mounds 2 feet deep, if compacted. Stake coir fiber logs or hay bales, or use rock to form the boundaries of the mound. Backfill holes with amended soil. Mound elevation should be 12-18 inches above the permanent pool based on typical dimensions of coir fiber logs. However, the center of the mound where trees are planted may be 18-24 inches above the permanent pool, to reduce the duration of inundation.

Tree mounds should incorporate one large shade tree and several small trees or shrubs, depending on the size of the island. Seedlings may be planted, but if larger stock is used, a dedicated water source must be available, and the stock should be from a wetland. Size of islands should relate directly to the size and number of trees desired (e.g., provide sufficient soil volume for each tree—usually at least 400 cubic feet).

Tree Clusters

Tree clusters should be used on side slopes ranging from 10:1 to 3:1 to provide additional soil volume and water for trees (Figure 25). Clusters should have a minimum of three trees and contain trees that have the same tolerance for the anticipated degree of inundation. Tree clusters should be used at various elevations all the way around the slopes and arranged so that any runoff from the sides of the cluster will be directed downhill to the next cluster. Tree clusters should consist of a series of interconnected planting holes to increase available soil volume.

After constructing wetland side slopes, excavate planting holes that are 3-4 feet deep for each tree cluster. The size of the hole depends on the ultimate size of the tree but should provide adequate soil volume, and holes should be adjacent to each other so trees can share rooting space. Backfill the hole with amended soil. Use spoils to construct a berm on the downslope side of the tree cluster. Elevation of planting hole should be 6 inches below the top of the berm to allow for some ponding during storm events. Overplant with seedlings for fast establishment and to compensate for mortality.

Wooded Wetland *Continued*

- Maintenance**
- Plan for minimal maintenance of trees (e.g., frequent watering may not be feasible).
 - Use tree shelters to protect seedlings from mowers and deer where needed.
 - Use Integrated Vegetation Management (IVM) to control vegetation in embankment and maintenance access areas. IVM entails maintaining low-growing vegetation (e.g., 6 feet high) through mowing, hand removal of vegetation, or selection spraying (with herbicide approved for aquatic use) of individual trees in early growing stage (Genua, 2000).
 - Do not mow wetland side slopes except for initial mowing required when native grasses are used.
-

- Topics for Future Research**
- Additional guidance is needed on weir wall design or design of an alternative outlet structure that resists clogging and addresses seepage and uplift.
 - Need additional guidance on designing ponds and wetlands to preserve existing trees.
 - May need alternative to coir fiber logs for mounds near a permanent pool.
 - Measure changes in water quality due to trees in wetlands.
-

Further Resources

Genua, S. M. 2000. Converting power easements into butterfly habitats. Washington, DC: Potomac Electric Power Company (PEPCO).
www.butterflybreeders.org/pages/powerease_sg.html

Schueler, T. R. 1992. Design of stormwater wetland systems: guidelines for creating diverse and effective stormwater wetlands in the mid-Atlantic Region. Washington, DC: Metropolitan Washington Council of Governments.

U.S. Army Corps of Engineers. 1989. Retaining and flood walls. Engineer Manual No. 1110-2-2502. Washington, DC: U.S. Army Corps of Engineers.

Bioretention and Bioinfiltration Facilities

Description Bioretention and bioinfiltration facilities are shallow, landscaped depressions that contain a layer of prepared soil, a mulch layer, and vegetation. These facilities provide filtering of storm water runoff by temporarily ponding water during storms. Bioretention facilities have underdrain systems, while bioinfiltration facilities allow runoff to infiltrate into existing site soils (infiltration rates greater than 0.5 inches per hour).

The standard bioretention and bioinfiltration designs sometimes incorporate trees, but mainly as a landscaping “afterthought.” The concept design presented here not only incorporates trees and shrubs, but has also been modified to improve growing conditions and decrease potential engineering conflicts (Figure 26). Planting trees and shrubs in bioretention and bioinfiltration facilities may increase nutrient uptake and evapotranspiration.

Bioretention and bioinfiltration facilities are typically small (footprints are generally 5% of the impervious area they receive drainage from, drainage areas are less than 2 acres) and can be used in many applications. Where space is available, a forested or multi-zone filter strip may be used as pretreatment for bioretention and bioinfiltration facilities.

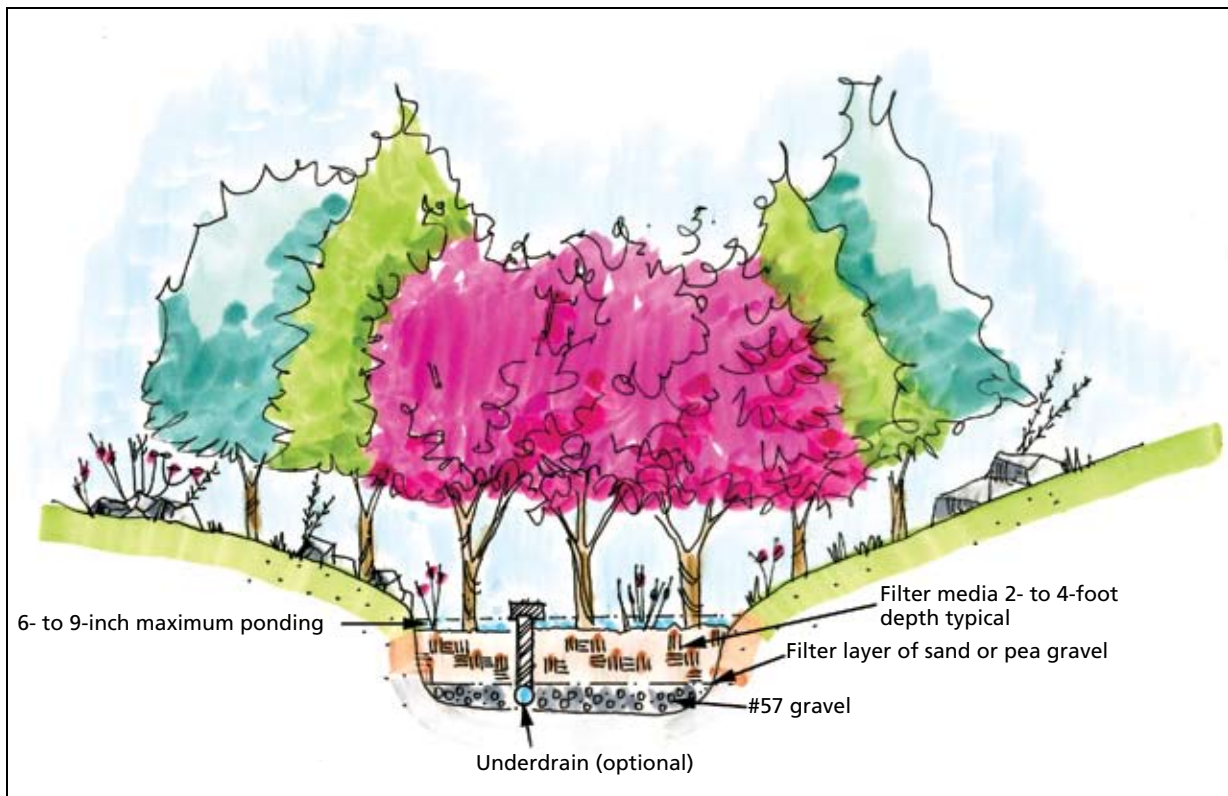

Figure 26. Bioretention and bioinfiltration facilities remove pollutants from storm water runoff using a filter medium.

Bioretention and Bioinfiltration Facilities *Continued*

- Design Modifications**
- Filter fabric should not be used between the filter media and the gravel jacket around the underdrain, as it creates an undesirable soil/water interface. A filter layer of sand or pea gravel may be used in lieu of filter fabric in this area to prevent the migration of fines into the gravel layer below. Ferguson (1994) provides a formula for determining the composition of this sand layer, and Prince George's County (2001) provides guidance on use of a pea gravel layer. Filter fabric may not be necessary along the sides of the excavated area unless there is concern about lateral movement of water into the adjacent soil (e.g., in applications where lateral seepage may cause upheaval of adjacent pavement).
 - Use #57 (i.e., 1 ½-inch diameter) gravel instead of #2 around underdrain to provide some filtering. The underdrain may be suspended within #57 gravel to provide enhanced recharge and infiltration by increasing the stone reservoir.
 - Allow for 6-9 inches of ponding during storm events.
-

- Species Selection**
- Species selection is key in bioretention designs since it is more efficient than trying to change the site characteristics. Select a minimum of three hardy, native tree species that are adapted to soil and site conditions. Other desirable species characteristics may include the following:
- Tolerant of inundation
 - Tolerant of drought
 - Wide spreading canopy
 - Tolerant of salt
-

- General Planting Guidance**
- Have a landscape architect create a planting plan for the facility.
 - Do not plant trees directly over the underdrain as a precautionary measure.
 - Excavate the center only to a depth of 4 feet and backfill with filter media (infiltration rate of at least 0.5 feet per day). Use existing soil on side slopes (minimum 4:1 slopes). Use a filter medium with a lower sand ratio, or plant large trees only on side slopes to reduce potential for upheaval.
 - Overplant with bare root seedlings for fast establishment and to account for mortality. Alternatively, plant larger stock when a dedicated water source is available using desired spacing intervals (35-50 feet for large and very large trees) and random spacing, or use a mix of seedlings and larger stock.
 - Provide adequate soil volume for trees: in general, 2 cubic feet of useable soil for every square foot of mature canopy (Urban, 1999). Assume some shared rooting space between trees.
-

-
- Maintenance* Use tree shelters to protect seedlings where deer predation is a concern.
- Use mulch to retain moisture.

-
- Topics for
Future
Research* Quantify increased pollutant removal due to trees in facility.

-
- Further
Resources* Center for Watershed Protection. 1996. Design of stormwater filtering systems. Ellicott City, MD.
- Ferguson, B. K. 1994. Stormwater infiltration. Boca Raton, FL: CRC Press, Inc.
- Prince George's County. 2001. Bioretention manual. Upper Marlboro, MD: Department of Environmental Resources Program and Planning Division.
- Urban, J. 1999. Room to grow. Treelink 11: 1-4.
-

Alternating Side Slope Plantings (Swale)

Description Alternating side slope plantings are trees planted on the side slopes of a dry swale or other open channel conveyance system in an alternating pattern. Alternating side slope plantings can be used in open channels with longitudinal slopes up to 2%, to provide shade, rainfall interception, limited slope stabilization, and esthetic value.

Design Modifications None.

Species Selection Species selection is key because it is more efficient than trying to change the site characteristics. Select a diverse mix of hardy, native species with the following characteristics:

- Tolerant of inundation
 - Tolerant of salt
 - Wide spreading canopy.
-

General Planting Guidance

- Trees should be planted singly or in clusters in an alternating pattern on the side slopes. As a general rule, tree or cluster spacing should be six times the channel width (Figure 27), to impose meanders on channel flow.
- Stock can be seedlings (overplant for fast establishment and to account for mortality) or larger stock planted at desired spacing intervals.
- Excavate planting hole to a depth of 2-4 feet and backfill with amended soil if existing soil is compacted.
- The channel bottom and side slopes may be planted with turf or with native grasses (if able to withstand the runoff velocity the swale is designed to convey).
- Establish a defined edge on the top slope of the channel using trees, shrubs, or spaced rock. This edge protects trees from mowers and provides a visual border to let residents know the plantings are intentional.

Maintenance

- Use mulch to retain moisture
- Mow around trees regularly if turf, or twice a year if native grasses.
- Use mulch, tree shelters, or rock borders to protect trees from lawn mowers.

Topics for
Future
Research

- Is there potential for trees to shade out grass and contribute to erosion?
- What species can be planted on channel bottom and around trees as an alternative to turf that can also withstand the runoff velocity the swale is designed to convey?

Further
Resources

Center for Watershed Protection. 1996. Design of stormwater filtering systems. Ellicott City, MD.

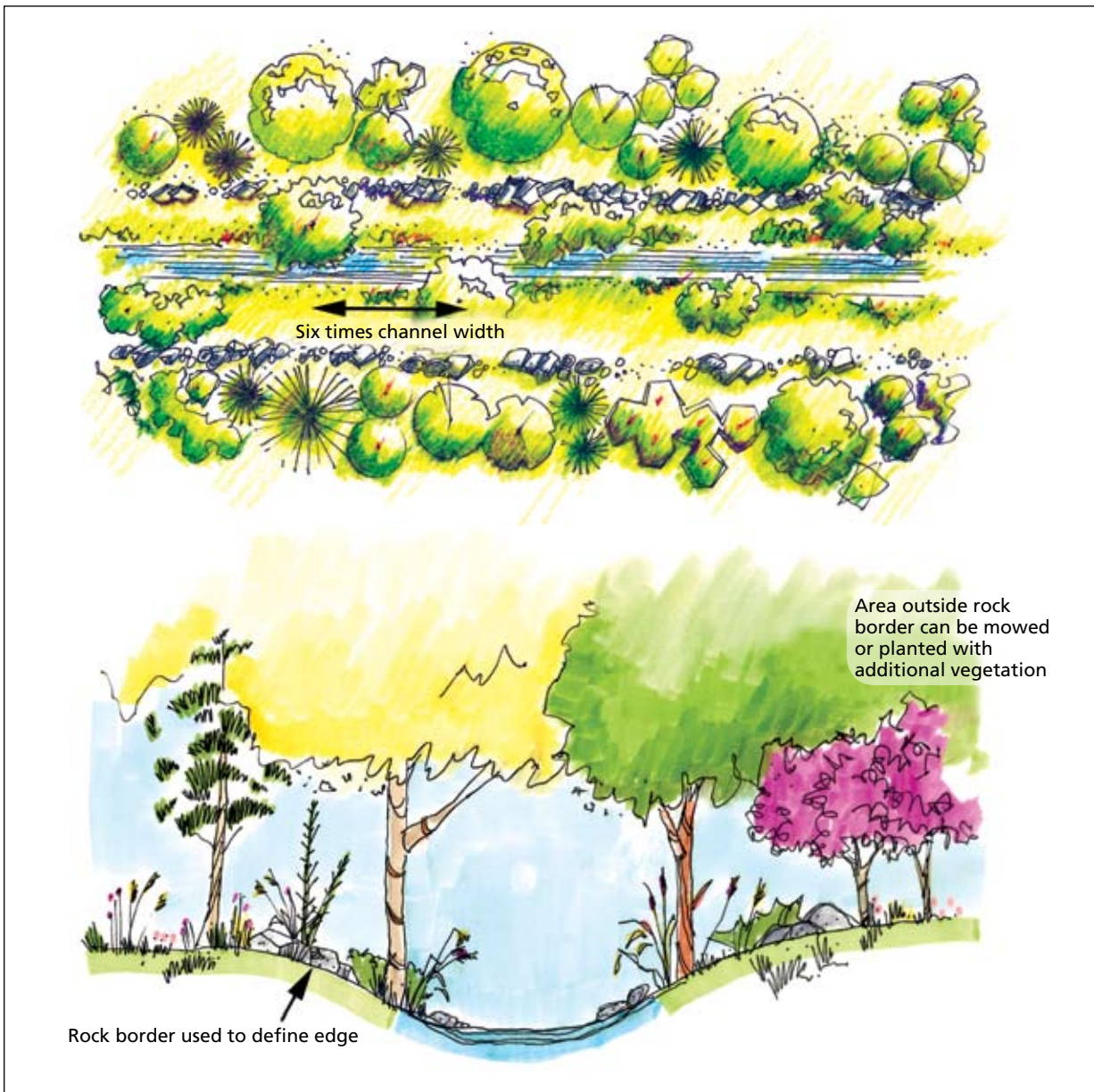

Figure 27. Alternating side-slope plantings are an attractive way to incorporate trees into swales without obstructing channel flow.

Tree Check Dams (Swale)

Description Open channel conveyance systems such as dry swales often incorporate check dams to slow runoff and prevent erosion, when longitudinal slopes range from 2% to 6%. Traditional check dams are constructed of rock, railroad ties, or other material. Tree check dams (Figure 28) use tree mounds (Figure 24 on page 31) to dissipate velocity. Tree check dams may also increase evapotranspiration and pollutant removal in the swale soils.

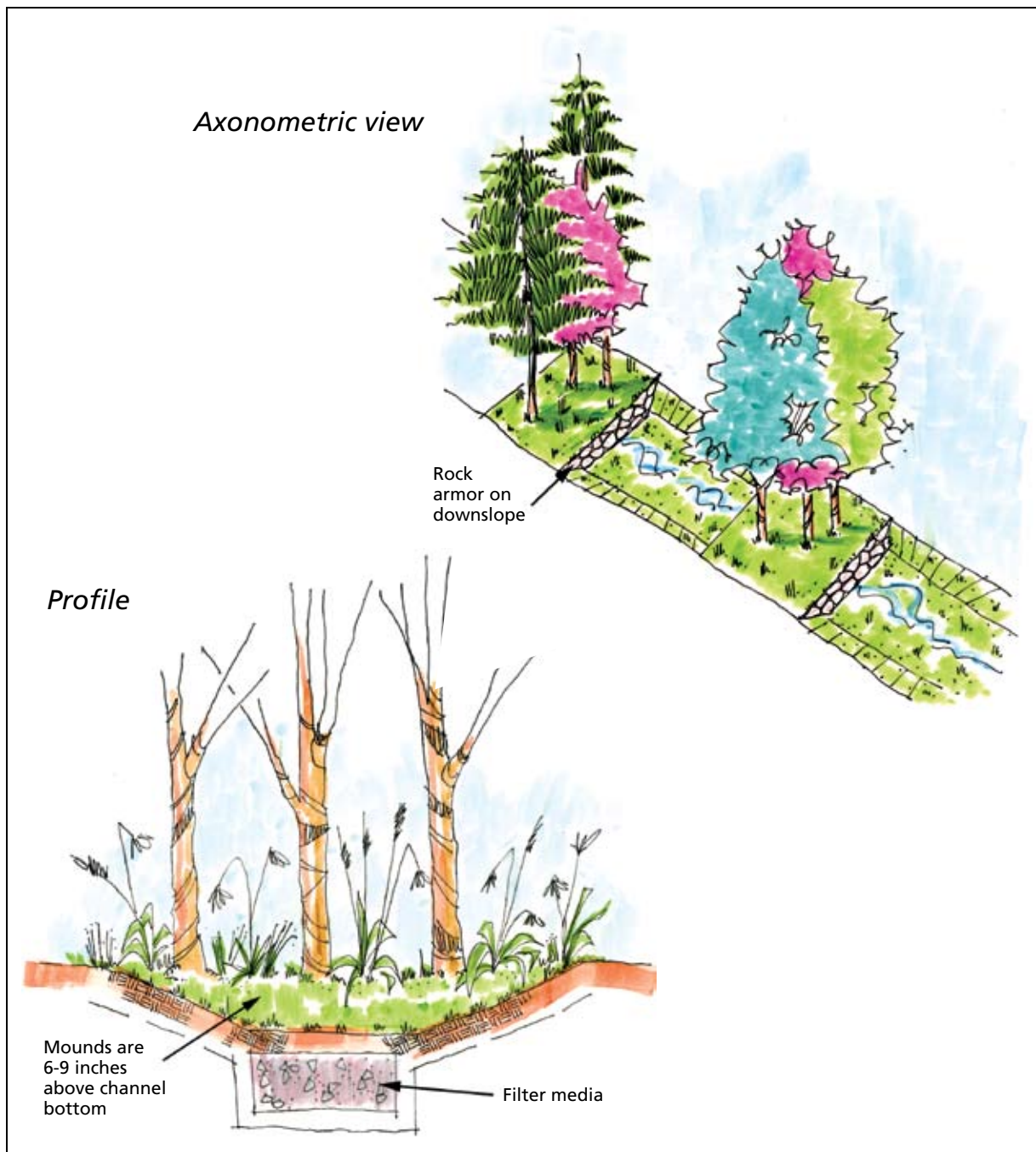

Figure 28. Tree check dams slow runoff and prevent erosion in swales with slopes of 2% to 6%.

Design Modifications Account for increased roughness and reduced capacity by subtracting the cross-sectional area of trees from the channel cross-section when computing channel capacity.

Species Selection Species selection is key because it is more efficient than trying to change the site characteristics. Select a diverse mix of hardy, native species that are adapted to soils and site conditions.

In particular, consider the size of trees at maturity in relation to channel width. Trees that are too large may block flow across the channel, so small trees and shrubs may be best for check dams. Other desirable species may have these characteristics:

- Tolerant of inundation
 - Tolerant of salt
-

- General Planting Guidance**
- Spacing of check dams should be such that the toe of the upstream dam is at the same elevation as the top of the downstream dam.
 - Check dam mounds should be no higher than 6-9 inches above the bottom (invert) of the channel.
 - The mound should be constructed across the entire width of the channel, and have a weep hole or armored opening to allow ponded water to seep through the mound. Mounds should be armored with rock on the downslope side, particularly on steeper slopes, to protect from erosion.
 - Excavate to a depth of 3-4 feet and backfill with amended soil if existing soil is compacted.
 - Plant trees and shrubs on the mounds, using bare root seedlings to minimize transplant stress to roots.
 - Plant turf grass or native grasses (if able to withstand the runoff velocity the swale is designed to convey) along the channel bottom and side slopes.
-

- Maintenance**
- Use mulch to retain moisture.
 - Periodically remove debris and trash from the check dams.
 - Use mulch, tree shelters, or rock to protect the tree from lawnmower damage.
 - Mow turf regularly or native grasses twice a year.
-

Tree Check Dams (Swale) *Continued*

- Topics for Future Research*
- Will tree mounds be stable enough to withstand high flows?
 - Should larger stock be used to prevent seedlings from washing away?
 - Is there potential for trees to shade out grass and contribute to erosion?
 - What species can be planted on the channel bottom and around trees as an alternative to turf that can also withstand the runoff velocity the swale is designed to convey?
 - Can dimensions of tree mounds be further defined?
-

Further Resources Center for Watershed Protection. 1996. Design of stormwater filtering systems. Ellicott City, MD.

Metro. 2002. Green streets: innovative solutions for stormwater and stream crossings. Portland, OR.

Forested Filter Strip

Description

A traditional filter strip is a grass area that is intended to treat sheet flow from adjacent impervious areas. Sheet flow is runoff that flows over land with no defined channels. Filter strips function by slowing runoff velocities, filtering out sediment and other pollutants, and providing some infiltration into underlying soils.

A forested filter strip provides a similar function but incorporates trees and a small ponding zone (optional) into the design (Figures 29 and 30). The ponding zone is a small depression with a low berm where water ponds during most storm events (e.g., around a 1-inch rainfall). The entire filter strip is planted with trees and shrubs, but since the depression is wetter than the remainder of the practice, the two zones are distinguished by referring to them as the ponding zone and the forested zone. Additional benefits provided by a forested filter strip include evapotranspiration, wildlife habitat, and infiltration promoted by macropore formation.

Forested filter strips may be used as follows:

- In linear areas such as stream buffers and transportation corridors.
- As pretreatment for a stream buffer or other storm water treatment practice.
- Where visual screening or a buffer is desired.

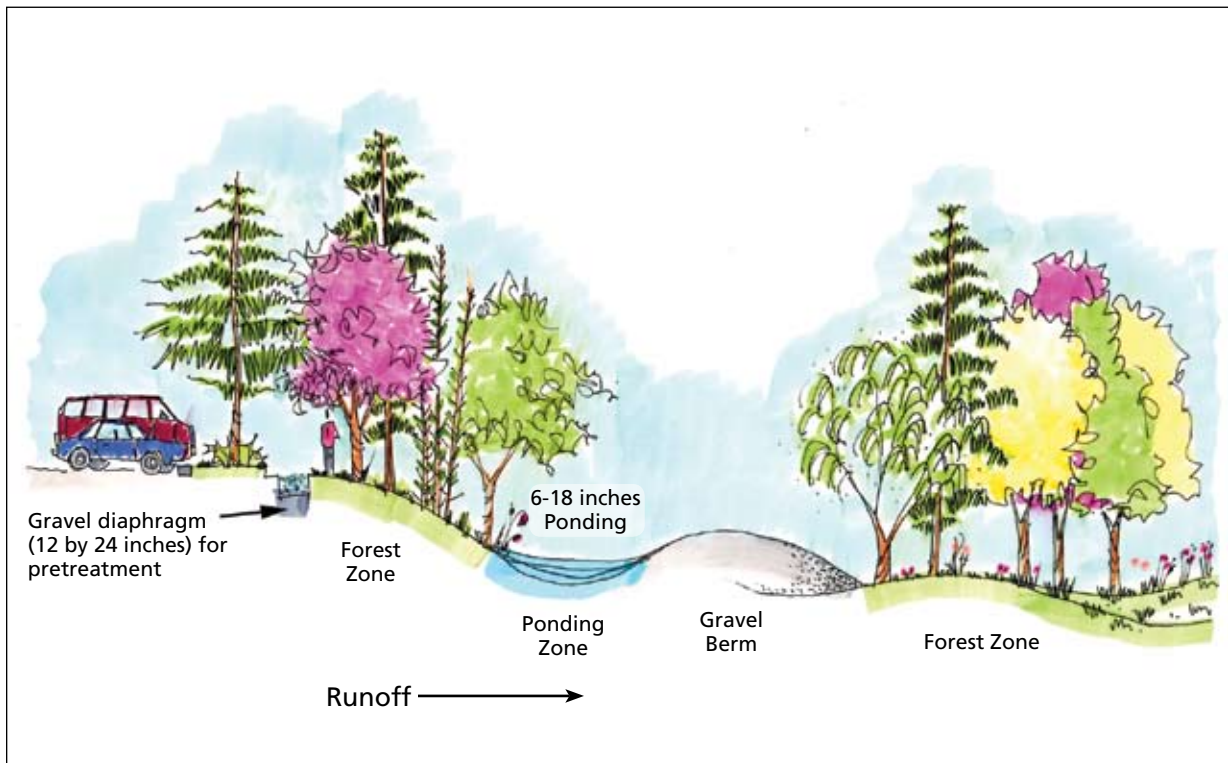

Figure 29. Forested filter strip profile shows how runoff flows through the various zones.

Forested Filter Strip *Continued*

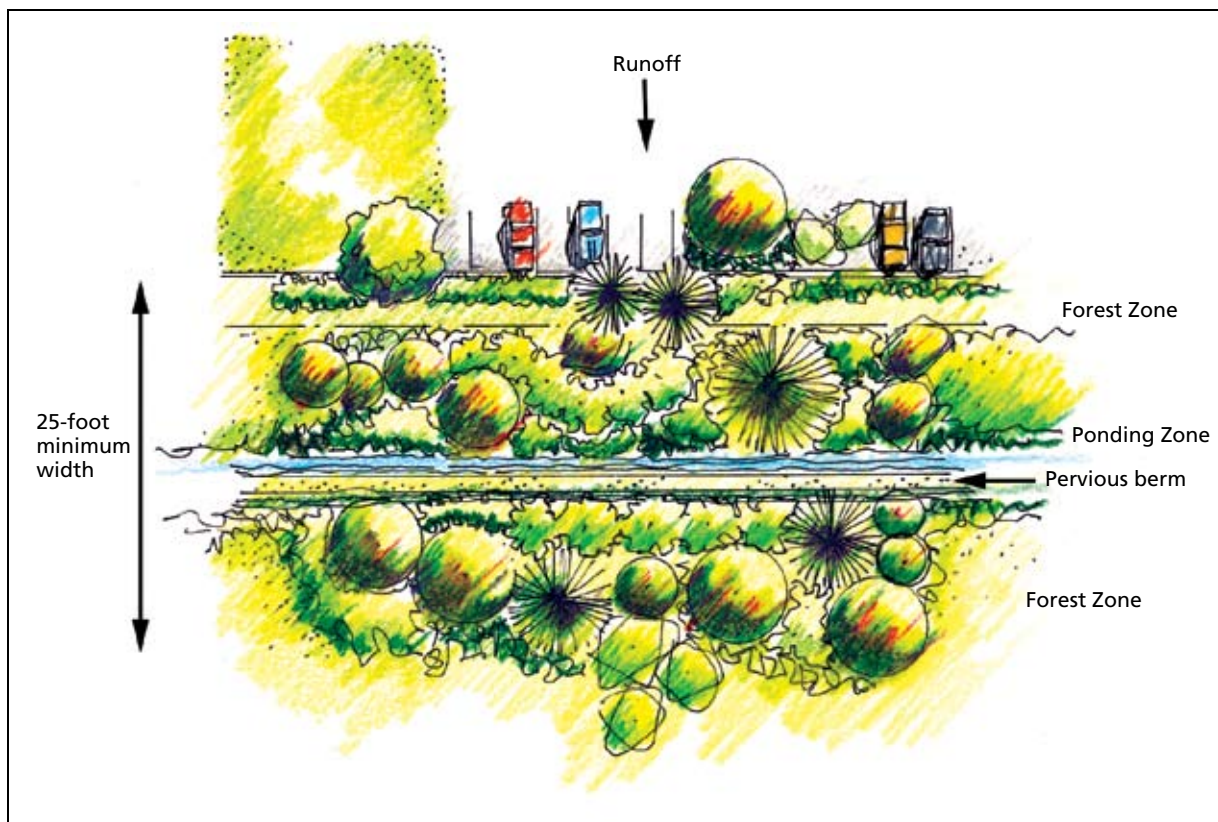

Figure 30. Forested filter strip plan shows its suitability to a linear area.

Design Modifications

- Unlike a traditional grass filter strip, the forested filter strip is not limited to accepting sheet flow runoff. If runoff is concentrated, the filter strip inlet should be armored with rock.
- Use a gravel diaphragm for pretreatment (acts as a level spreader and allows fine sediment to settle out where sheet flow is present).
- When a significant volume of storm water runoff is expected, the forested filter strip should have a small berm constructed of pervious material such as gravel, rock, or earth. If the berm is earthen, insert weep hole pipes so ponded water filters to the other side. If the berm is gravel, gabions may be used. A gabion is a wire mesh cage filled with rock and is used to prevent erosion. The height of the berm should be 6-18 inches above the bottom of the depression and at least 6 inches below the lowest inflow elevation.
- Overall dimensions should provide surface storage for the water quality volume. During larger storms, runoff will overtop the berm. Minimum width of the filter strip should be 25 feet. The slope should range from 2% to 6%.

Species Selection Existing trees should be incorporated into the design where possible. Otherwise, select a diverse mix of native species (minimum of three) that have these characteristics:

- Tolerant of salt
- Tolerant of inundation (standing water in ponding zone, fluctuating water levels in forested zone).

General Planting Guidance

- Shrubs and small trees can be incorporated into the ponding zone, and larger trees can be incorporated into the forested zone.
- Conserve existing soil, if undisturbed, and use soil amendments if site soils are compacted.
- Overplant with seedlings for fast establishment and to account for mortality. Alternatively, plant larger stock at desired spacing intervals (35-50 feet for large and very large trees) using random spacing.

Maintenance

- Use mulch to retain moisture.
- Use tree shelters to protect seedlings.

Topics for Future Research

- Quantify increased pollutant removal due to trees in filter strip.

Further Resources

Center for Watershed Protection. 1996. Design of stormwater filtering systems. Ellicott City, MD.

Maryland Department of the Environment. 2000. Maryland stormwater design manual. Baltimore, MD.

Multi-Zone Filter Strip

Description A traditional filter strip is a grass area that is intended to treat sheet flow from adjacent impervious areas. Sheet flow is runoff that flows over land with no defined channels. Filter strips function by slowing runoff velocities and filtering out sediment and other pollutants, and providing some infiltration into underlying soils.

A multi-zone filter strip provides a similar function but incorporates trees and shrubs into the design. A multi-zone filter strip features several vegetation zones that provide a gradual transition from turf to forest (Figures 31 and 32). The zones are turf, meadow, shrub, and forest. The multi-zone filter strip can be effectively designed as a transition filter zone to an existing forest area. Additional benefits provided by a multi-zone filter strip include evapotranspiration, wildlife habitat, and infiltration promoted by macropore formation.

Multi-zone filter strips may be used as follows:

- In linear areas such as stream buffers and transportation corridors.
- As pretreatment for a stream buffer or other storm water treatment practice.
- Where runoff is present as sheet flow and travels over short distances (a maximum of 75 feet of impervious area, or 150 feet of pervious area).
- Where safety and visibility are concerns (e.g., next to parking lot or public area)

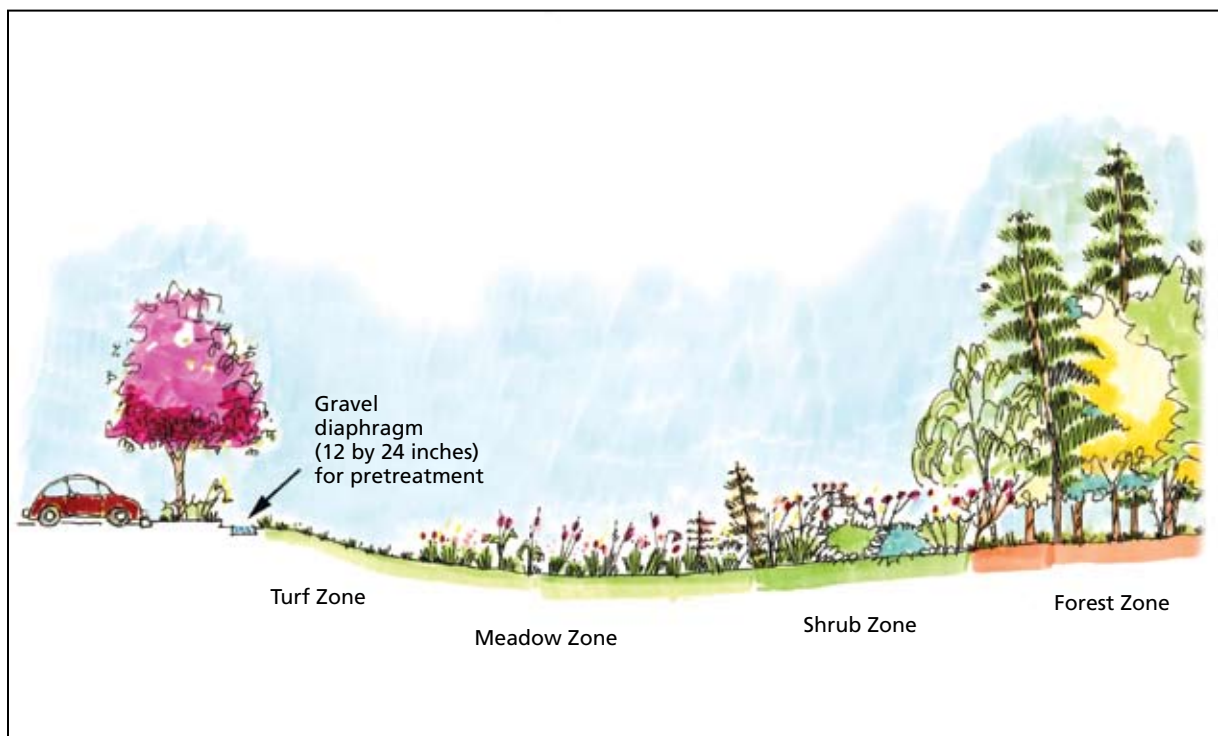

Figure 31. A multi-zone filter strip (profile) includes four successive vegetation zones.

| | |
|----------------------------------|--|
| Design Modifications | <input type="checkbox"/> Use curb stops or parking stops to keep cars from driving on the grass area, if next to a parking lot. <input type="checkbox"/> Use a gravel diaphragm for pretreatment. <input type="checkbox"/> Minimum width of filter strip should be 25 feet. <input type="checkbox"/> When a significant volume of stormwater runoff is expected, a small berm and ponding area may be incorporated as described in the Forested Filter Strip. |
| Species Selection | <p>Existing trees should be incorporated where possible. Otherwise, select and plant a minimum of three native species with these characteristics:</p> <input type="checkbox"/> Tolerant of inundation <input type="checkbox"/> Tolerant of salt |
| General Planting Guidance | <input type="checkbox"/> Plant each zone with the desired vegetation. Widths of each vegetative zone may vary. Shrub zone may ultimately become a tree zone. <input type="checkbox"/> Conserve existing soil, if undisturbed, and use soil amendments if compacted. <input type="checkbox"/> Overplant with seedlings for fast establishment and to compensate for mortality, or plant larger stock at desired spacing intervals (35-50 feet for large and very large trees) using random spacing. |
| Maintenance | <input type="checkbox"/> Use mulch to retain moisture. <input type="checkbox"/> Use tree shelters to protect seedlings. <input type="checkbox"/> Mow turf zone regularly and reseed as needed. <input type="checkbox"/> Mow meadow zone twice a year. |

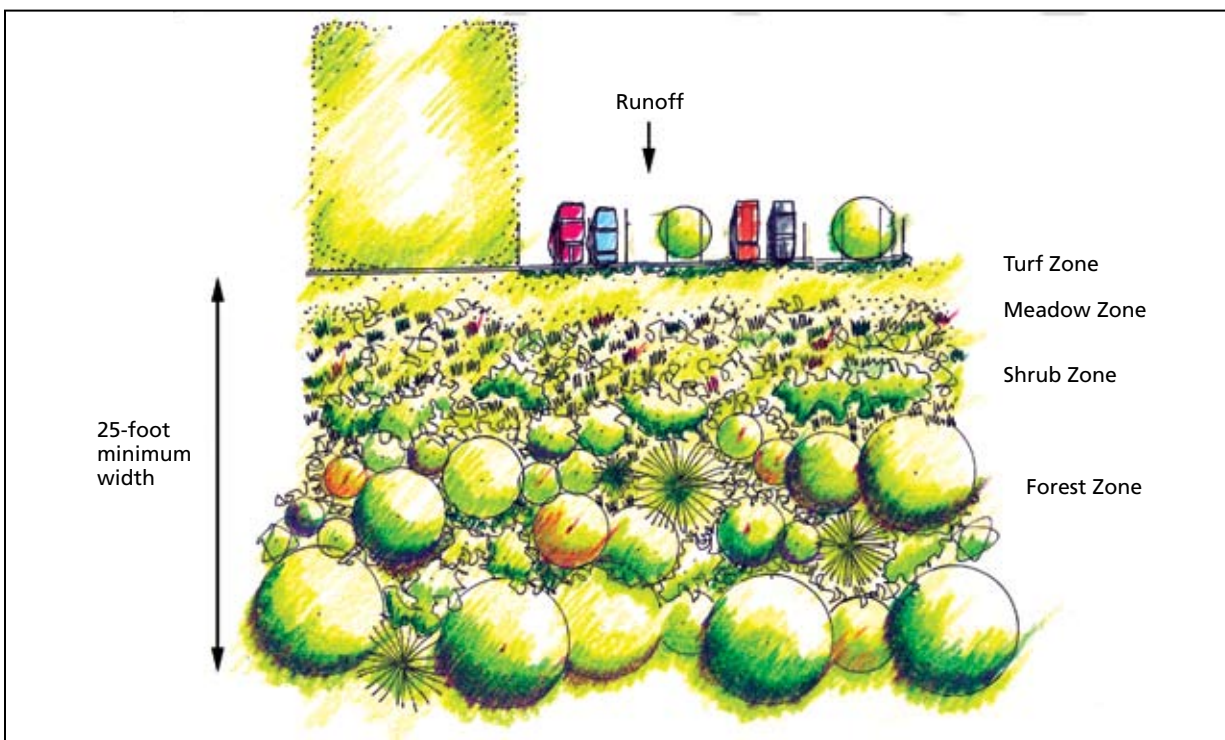

Figure 32. A multi-zone filter strip (plan) requires a minimum width of 25 feet.

Multi-zone Filter Strip *Continued*

*Topics for
Future
Research*

Quantify additional pollutant removal due to trees in filter strip.

*Further
Resources*

Center for Watershed Protection. 1996. Design of stormwater filtering systems. Ellicott City, MD.

Maryland Department of the Environment. 2000. Maryland stormwater design manual. Baltimore, MD.

Linear Storm Water Tree Pit

Description A linear storm water tree pit is similar to a traditional street tree pit design, but is modified so the pit accepts and treats storm water runoff and provides an improved planting environment for the tree. A storm water tree pit has additional soil volume, regular irrigation, and better drainage to promote tree growth. A continuous soil trench underneath the pavement connects individual tree pits (Figures 33 and 34).

Linear storm water tree pits are most useful for the following conditions:

- Where existing soils are very compacted or poor.
- Where open space for planting is limited (e.g., highly urban areas) and rooting space can be provided for trees underneath pavement.
- In street tree or other linear applications (although it can be adjusted for a different application, such as clustered plantings in a courtyard).
- New development, or as a retrofit of existing development, when done in conjunction with repair of underground utilities or a streetscaping project that requires sidewalk excavation.

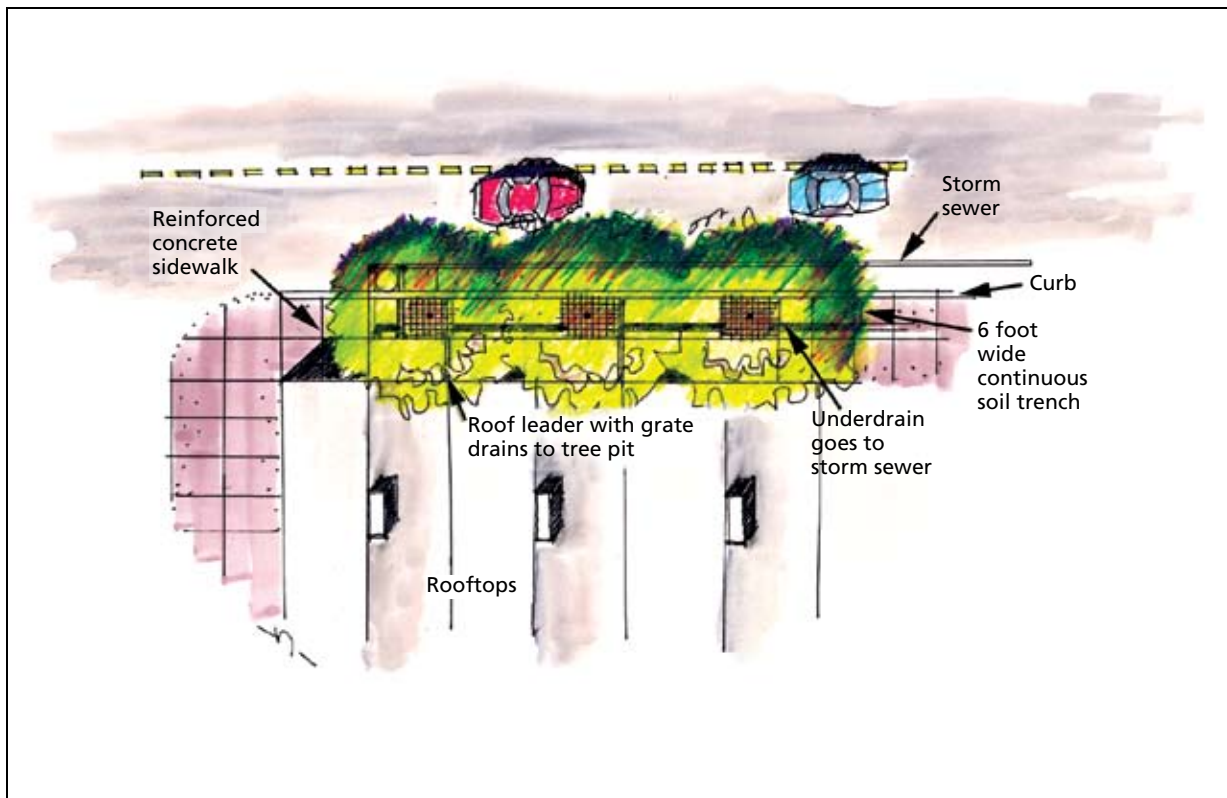

Figure 33. A linear storm water tree pit (plan view) collects and treats storm water that is directed from rooftops.

Linear Storm Water Tree Pit *Continued*

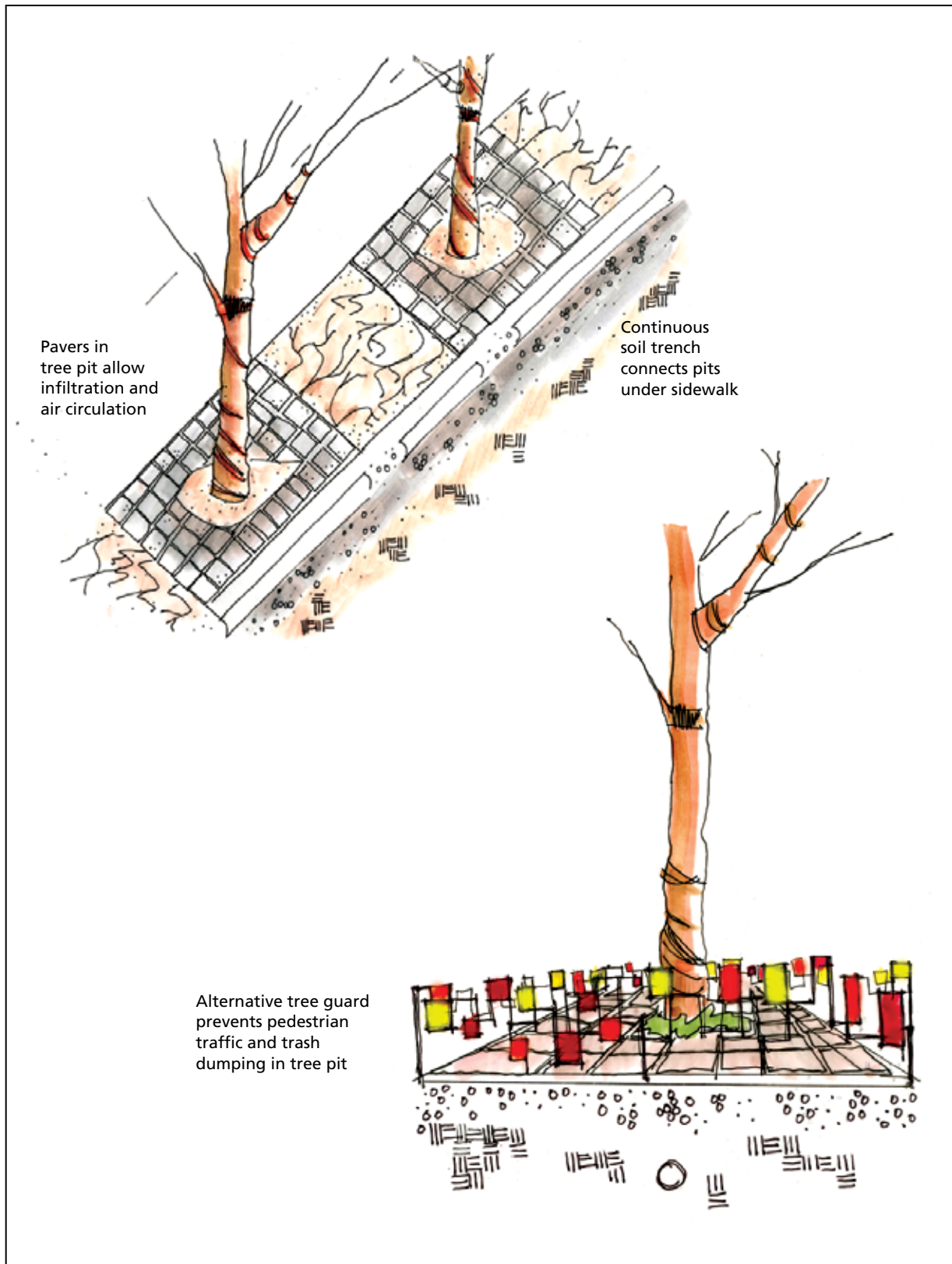

Figure 34. Tree pits are connected through a soil trench, and tree pit protection prevents damage from pedestrian traffic.

-
- Design Modifications**
- Storm water is directed from rooftops to tree pits using sunken roof leaders covered with grates. An alternative is to use curb cuts to direct street runoff to the pits for added water quality benefits. In this case, a filter screen or cleanout device must be provided to capture trash and litter.
 - An underdrain that connects either to existing storm drain inlets or to the storm sewer is installed under tree pits. The underdrain is surrounded by a layer of gravel to provide some filtering. A variation is to add a gravel base under the underdrain to allow some infiltration.
 - Trees are planted within a linear trench with filter medium to allow filtering of storm water and shared rooting space for trees underneath pavement.
 - Reinforced concrete sidewalks should have wide surface openings to accommodate the mature size of the trees (sidewalks will be cantilevered over planting holes).
 - Consider use of structural soils under pavement, which allows tree roots to grow in it and also meets engineering specifications (see Bassuk and others (n.d.) and Part 3 of this manual series for more information).

-
- Species Selection**
- Species selection is critical in storm water tree pits because unmodified site conditions are often highly stressful to healthy tree growth. A mix of hardy species should be selected that are adapted to the following soil and site conditions:
- Tolerant of poor, compacted soils
 - Tolerant of salt
 - Tolerant of urban pollutants
 - Tolerant of inundation
 - Tolerant of drought
 - Wide spreading canopy

-
- General Planting Guidance**
- Excavate a planting trench 3-4 feet deep and a minimum of 6 feet wide. The volume for each tree should be adequate for the mature size of the tree, assuming some shared soil volume. Backfill trench with filter medium. The top of the planting trench should be slightly below grade to allow space for air circulation.
 - Plant at desired spacing intervals.
 - Install concrete posts, fencing, or other structures (see Figure 34) to prevent pedestrians from stepping in tree pit (tree grates are not recommended since they can damage the tree if they are not adjusted as it grows).
-

Linear Storm Water Tree Pit *Continued*

Maintenance Use mulch to retain moisture.

**Topics for
Future
Research** Need better method to prevent use of tree pits as trash cans.
 Develop guidance on sizing and volume of tree pits so as not to direct
too much water into pits.

**Further
Resources** Bassuk, N.; Grabosky, J.; Trowbridge, P.; Urban, J. [N.d.]. Structural soil:
an innovative medium under pavement that improves street tree vigor. Ithaca,
NY: Cornell University, Urban Horticulture Institute.
www.hort.cornell.edu/departement/faculty/bassuk/uhi/outreach/csc/article.html

Hammerschlag, R. S.; Sherald, J. L. 1985. Traditional and expanded tree
pit concepts. In: METRIA 5: Selecting and Preparing Sites for Urban Trees.
Proceedings of the Fifth Conference of the Metropolitan Tree Improvement
Alliance. University Park, PA: The Pennsylvania State University.

Hoke, J. R., Jr., ed. 2000. Architectural graphic standards, 10th ed. New York,
NY: John Wiley and Sons, Inc.

Urban, J. 1999. Room to grow. Treelink 11: 1-4.

Chapter 4. Planting Trees Along Streets and in Parking Lots

This chapter provides guidance on planting trees along local streets and within parking lots at new development sites. Pervious portions of a development site that make good candidates for tree planting and are often overlooked include local road rights-of-way, landscaped islands in cul-de-sacs or traffic circles, and parking lots. Many local landscaping ordinances often require developers to plant street trees or to landscape a certain percentage of every parking lot.

One of the most common features of highly desirable neighborhoods is the presence of large street trees that form a canopy over the road. Many newer developments either do not incorporate street trees or use small, ornamental trees or other types of vegetation within the planting strip (Figure 35). Street trees are traditionally planted in a linear fashion along either side of the road. Alternatives to this design include these: planting trees in clusters along the side of the road (Figure 36), planting trees within median strips (Figure 37), or planting trees in islands located in cul-de-sacs or traffic circles (Figure 38). Each planting area has specific considerations for incorporating trees to ensure adequate space is provided and to address common concerns about visibility and conflicts with overhead wires or pavement (Figure 39).



Figure 35. The environment differs drastically in a development with no street trees (top) from one with trees that matured to form a canopy over the street (bottom).

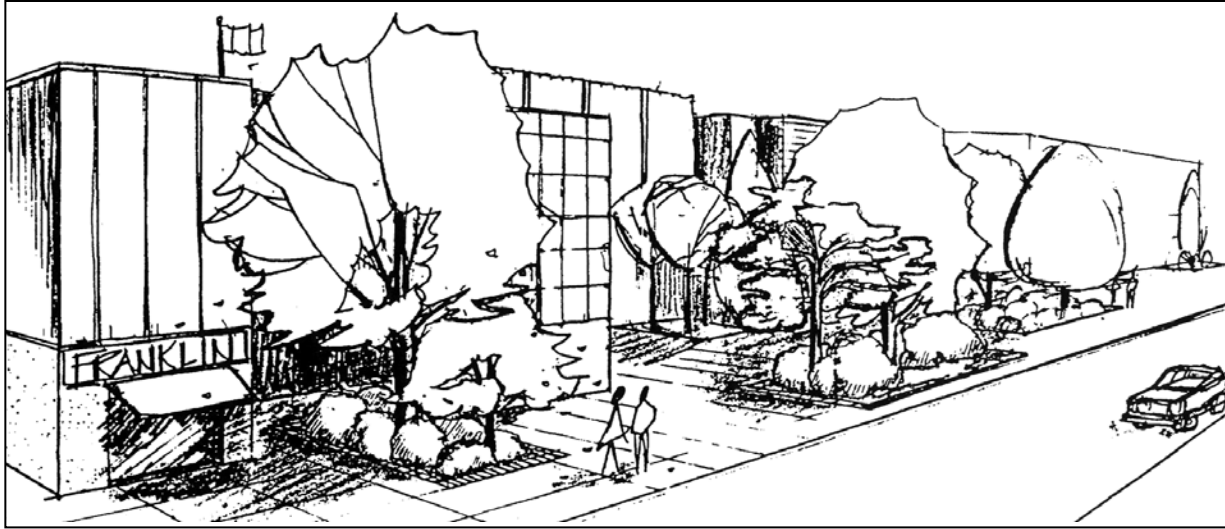

Figure 36. Non-linear street tree plantings are an alternative to linear roadside plantings. (Source: Meyer, n.d., p. 32)



Figure 37. Trees planted in a median strip provide shade, slow traffic, and make a street more attractive (left) than one with little vegetation (right).



Figure 38. A cul-de-sac (left) is typically overlooked as a place to plant trees (right) .



Figure 39. Trees planted in holes that are too small may eventually crack nearby pavement.

Trees in parking lots reduce the urban heat island effect, remove pollutants, provide shade and habitat for wildlife, and increase the esthetic value of the parking lot. Many commercial parking lots, however, use a “cookie cutter” design that does not incorporate trees (Figure 40). Because a parking lot can be a very harsh climate for a tree, several important design considerations are necessary.



Figure 40. The harsh environment of a parking lot (left) can be tempered by including an interior planting strip that allows trees to share rooting space (right).

Urban Watershed Forestry Manual - Part 2

Planting guidance for trees along streets and in parking lots is presented in the remainder of this chapter in fact sheet format. Each fact sheet contains the following sections:

Description – brief description of the planting concept.

Pre-Planting Considerations – potential conflicts with planting trees at the site or unique features that drive plant selection and planting procedures. Most of these considerations are addressed in the Species Selection, Site Preparation, Planting Guidance, or Maintenance sections.

Species Selection – desirable characteristics of species to be planted at the site. Part 3 of this manual series includes an Urban Tree Selection Guide with tree and shrub species and their characteristics.

Site Preparation – recommendations for preparing the site for planting.

Planting Guidance – recommendations for stock selection, planting zones, plant spacing and arrangements, and planting methods.

Maintenance – recommendations for tree maintenance.

Potential for Storm Water Treatment – potential for integrating trees and storm water treatment practices in that particular location.

Further Resources – resources for additional information.

Planting Trees Along Local Streets

Description

Local roads offer three areas to incorporate trees: the buffer, the median strip, and landscaped islands in cul-de-sacs or traffic circles (Figures 41 and 42). The buffer consists of the area between the edge of the road pavement and adjacent private property. The median strip is the area between opposing traffic lanes. Cul-de-sacs are large diameter bulbs that enable vehicles to turn around at the end of streets. They often involve large areas of pavement but present a good opportunity to plant trees in neighborhoods.

Trees planted along local roads can reduce air pollution and storm water runoff, provide habitat for wildlife such as birds, provide shade for pedestrians, reduce air temperatures, stabilize the soil, provide a visual screen and barrier from noise and highway fumes, and make for a visually pleasing environment for drivers and homeowners.

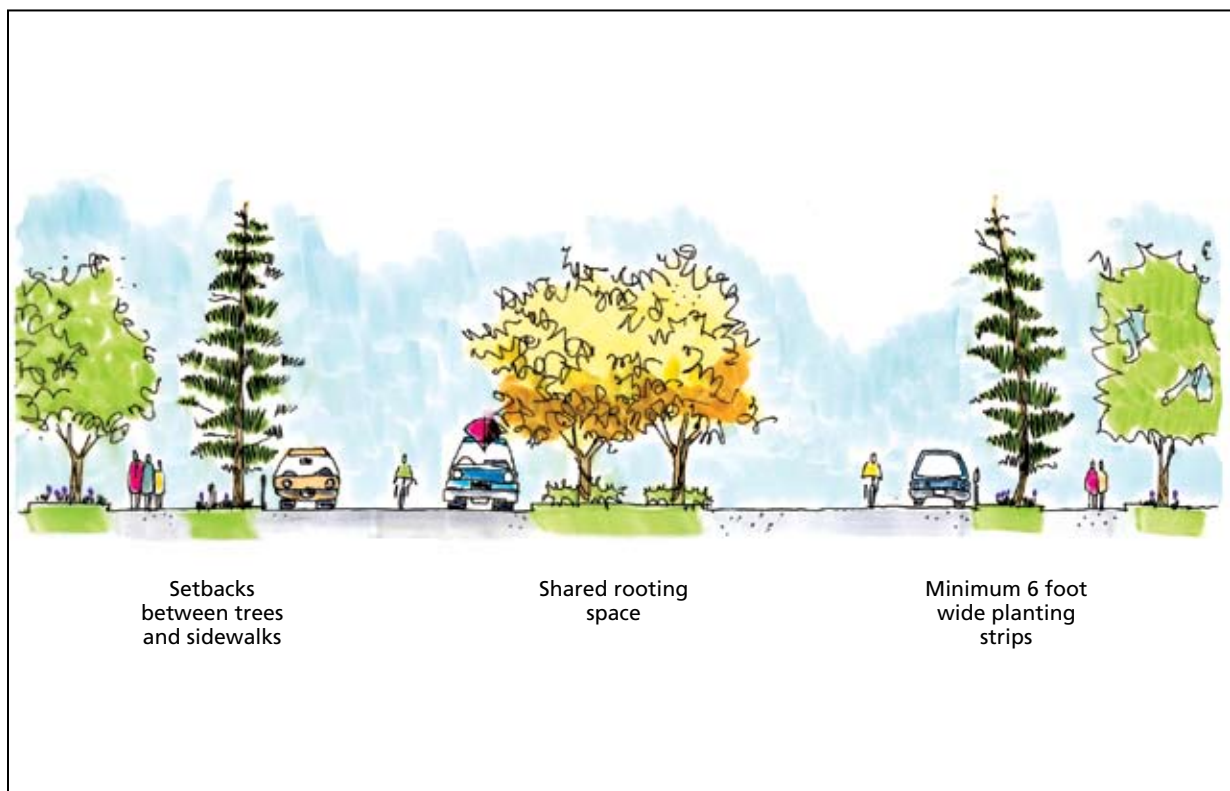

Figure 41. Trees can be incorporated into various planting areas along local roads.

Planting Trees Along Local Streets *Continued*

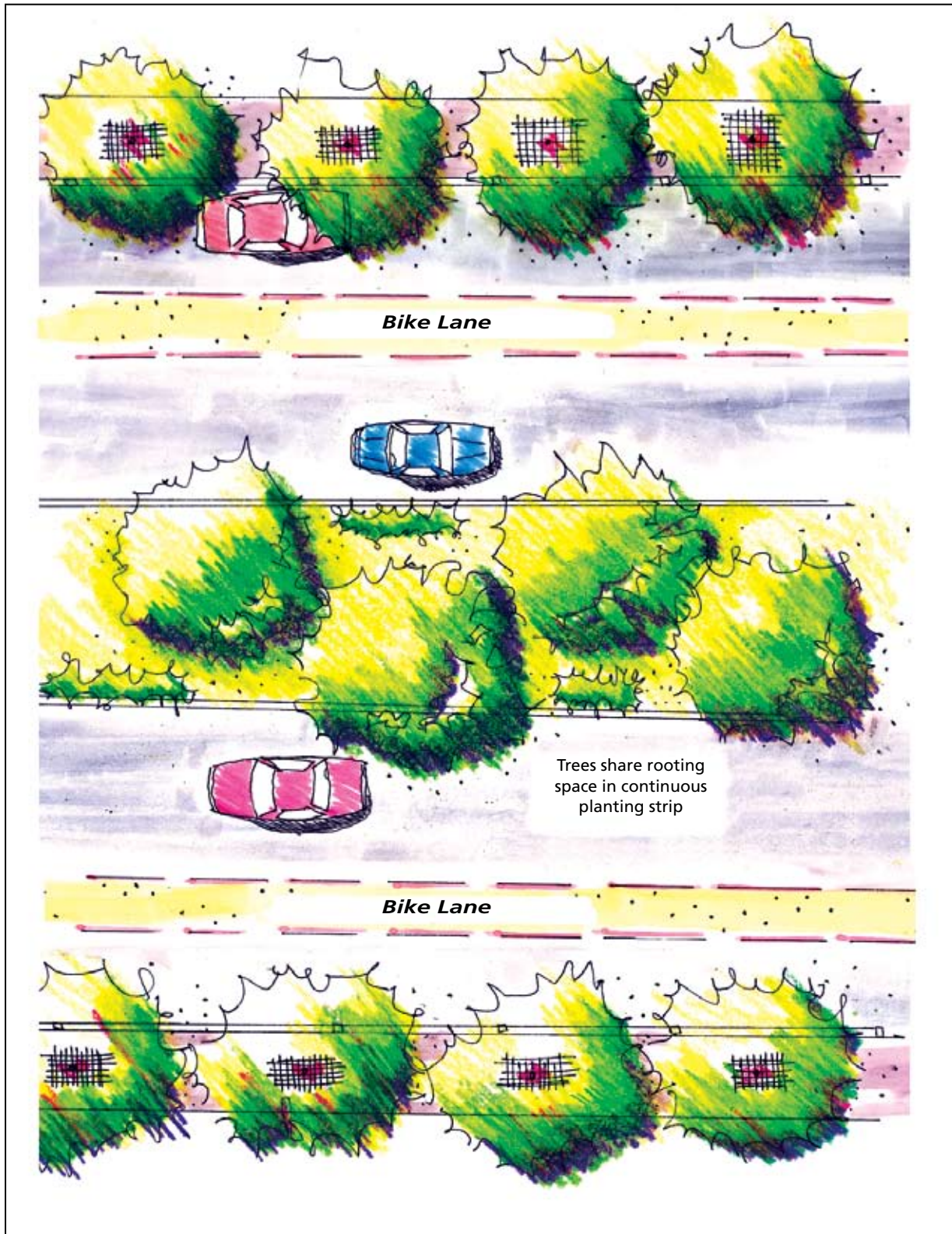

Figure 42. Tree planting along local roads (plan view) can utilize wide, linear planting areas to accommodate large, healthy trees.

-
- Pre-Planting Considerations** Before planting trees along local roads, designers need to address some important considerations:
- How to provide clear lines of sight, safe travel surfaces, and overhead clearance for pedestrians and vehicles
 - How to prevent compaction of planting area soils by construction and foot traffic
 - How to resolve potential conflicts between trees and utilities, pavement, and lighting
 - How to make the road corridor more attractive with plantings
 - How to reduce tree exposure to auto emissions, polluted runoff, wind, and drought
 - How to provide enough future soil volume for healthy tree growth
 - How to prevent damage to trees from cars
 - How to address concerns about increased tree maintenance, damage to cars from trees (e.g., sap, branches) and roadway snow removal and storage

-
- Species Selection** Species selection is very important in the road corridor, because of the many potential urban stressors associated with roadway planting. A diverse mix of hardy species should be selected that are adapted to soil and site conditions and are tolerant of the following:
- Drought
 - Poor or compacted soils
 - Inundation (if used for storm water treatment)
 - Urban pollutants (oil and grease, metals, chloride)
- In addition, select tree species with these characteristics:
- Do not produce abundant fruits, nuts, or leaf litter
 - Have fall color, spring flowers, or some other esthetic benefit
 - Can be limbed up to 6 feet to provide pedestrian and vehicle traffic underneath.

-
- Site Preparation**
- Clean up trash.
 - Improve soil drainage by tilling and adding compost.
 - Remove invasive plants if present.
-

Planting Trees Along Local Streets *Continued*

- General Planting Guidance**
- Provide adequate soil volume, preferably by having at least a 6-foot wide planting strip, or locating sidewalks between the buffer and street to allow more rooting space for the trees in adjacent property.
 - Provide adequate setbacks from utilities, signs, lighting, and pavement.
 - Use tree clusters as an alternative to linear plantings, which will provide shared rooting space.
 - Use structural soil under pavement to provide shared rooting space.
 - Use groupings of species that provide fall color, flowers, evergreen leaves, and varying heights to create an esthetically pleasing landscape.
-

- Maintenance**
- Use mulch to retain moisture.
 - Plan for minimal maintenance of trees (watering may not be feasible).
 - Water trees during dry periods if possible.
 - Have trees pruned by a qualified arborist to maintain sight lines and overhead clearance.
 - Monitor and control invasive species.
-

Potential for Storm water Treatment

Local road buffers and median strips are ideal locations to treat storm water runoff from roads. Trees planted in these areas can be incorporated in storm water forestry practices such as bioretention and bioinfiltration facilities, alternating side slope plantings, tree check dams, forested filter strips, multi-zone filter strips, and linear storm water tree pits.

Trees planted in landscaped islands can be used to intercept rainwater and treat storm water runoff from the surrounding pavement. Bioretention and bioinfiltration facilities may be well suited to cul-de-sac islands. See Chapter 3 for more detail on storm water forestry practices.

- Further Resources**
- Bassuk, N.; Grabosky, J.; Trowbridge, P.; Urban, J. [N.d.]. Structural soil: an innovative medium under pavement that improves street tree vigor. Ithaca, NY: Cornell University, Urban Horticulture Institute.
www.hort.cornell.edu/departement/faculty/bassuk/uhi/outreach/csc/article.html
- Costello, L. R.; Jones, K. S. 2003. Reducing infrastructure damage by tree roots: a compendium of strategies. Cohasset, CA: Western Chapter of the International Society of Arboriculture.
- Georgia Forestry Commission. 2002. Community tree planting and establishment guidelines. Macon, GA.
www.gfc.state.ga.us/Publications/UrbanCommunityForestry/CommunityTreePlanting.pdf
- Gerhold, H. D.; Wandell, W. N.; Lacasse, N. L. 1993. Street tree factsheets. University Park, PA: The Pennsylvania State University College of Agricultural Sciences.
- Metro. 2002. Green streets: innovative solutions for stormwater and stream crossings. Portland, OR.
-

Planting Trees in Parking Lots

Description

Parking lots have two distinct areas where trees can be planted—the interior and the perimeter—each of which has unique planting requirements and considerations (Figure 43). The parking lot interior can be a very harsh planting environment for trees, due to higher temperatures of the pavement, little water, exposure to wind, air pollution, and potential damage from automobiles. Landscaped islands are typically used within parking lots to provide a separation between parking bays and to meet landscaping requirements. These islands may be planted with grass, trees, or other vegetation and can be designed to accept storm water. Typically, most traditional parking lot islands do not provide adequate soil volumes for trees.

Trees planted along the perimeter of a parking lot provide a screen or buffer between the lot and an adjacent land use or road. Perimeter planting areas often provide a better planting environment for trees and good opportunities for conserving existing trees during parking lot construction.

The many benefits of incorporating trees in parking lots include shade for people and cars, reduction of the urban heat island effect, interception of storm water, improved esthetics, improved air quality and an increase in or creation of habitat for birds.

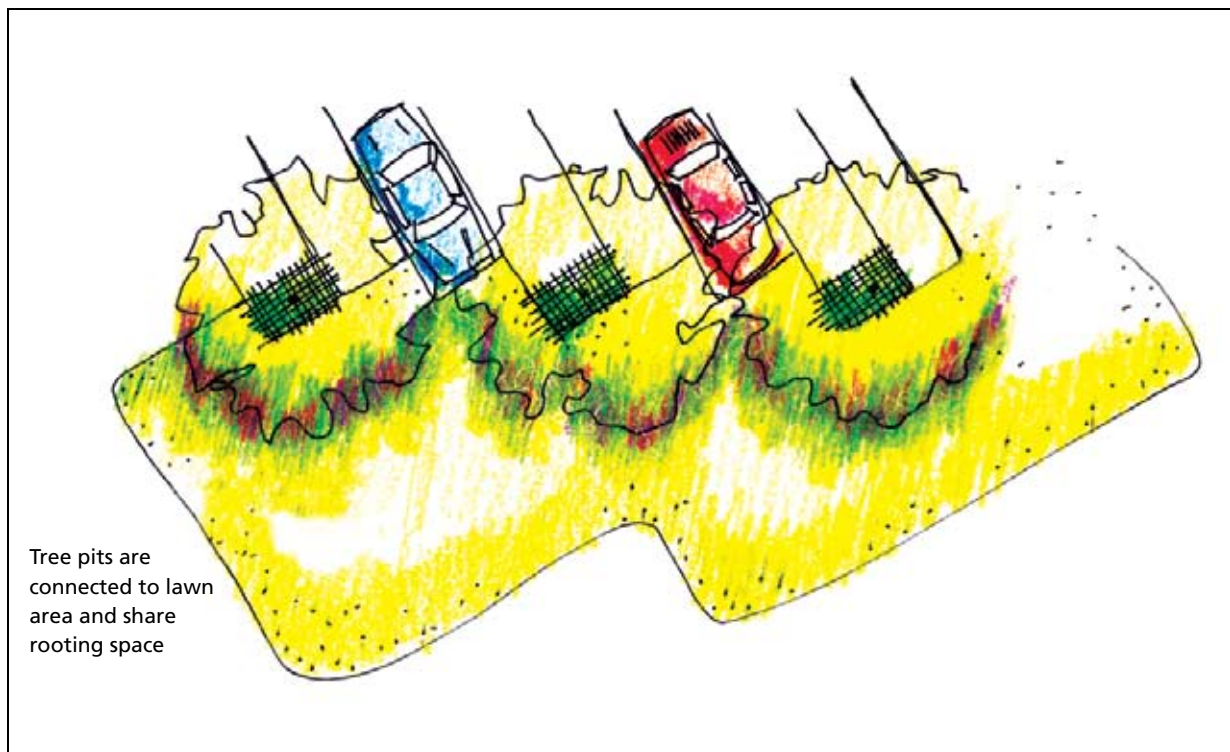

Figure 43. Parking lots can be designed to provide larger spaces to plant trees.

Planting Trees in Parking Lots *Continued*

Pre-Planting Considerations

Before planting trees in parking lots, designers need to address some important considerations:

- How to provide clear lines of sight, safe travel surfaces, and overhead clearance for movement of pedestrians and vehicles within the lot
- How to prevent compaction of planting area soils by construction and foot traffic
- How to resolve potential conflicts between trees and surrounding utilities, pavement, and lighting
- How to maximize canopy coverage and shading in the lot and make it more attractive with plantings
- How to reduce exposure of trees to auto emissions, polluted runoff, wind and drought
- How to provide adequate soil volume for trees in the confined space of a parking lot
- How to prevent damage to trees from cars
- How to address concerns about safety, increased maintenance due to tree litter, damage to cars from trees (e.g., sap, branches), and snow removal and storage
- How to maximize plantings for visual screening and buffers, at the same time offering view corridors to merchants

Species Selection

Species selection is important in urban parking lots because it is such a stressful environment. Tree species that comprise a diverse mix of hardy, native species that are adapted to soils and site conditions are needed.

The following characteristics should be sought when selecting a parking lot tree:

- Tolerant of salt
- Tolerant of drought and extreme temperatures
- Tolerant of poor, highly compacted soils
- Tolerant of urban pollutants
- Tolerant of inundation, if used for storm water treatment
- Does not produce abundant fruits, nuts, or leaf litter
- Wide-spreading canopy

Site Preparation

- Improve soil drainage by tilling soils and adding compost.
-

| | |
|----------------------------------|--|
| General Planting Guidance | <input type="checkbox"/> Use structural soils below pavement to allow for root growth where possible. <input type="checkbox"/> A few great trees are better than a lot of smaller ones. <input type="checkbox"/> Design concave planting areas to discourage pedestrian traffic. <input type="checkbox"/> Provide adequate setbacks from utilities, signs, lighting, and pavement. <input type="checkbox"/> Plant only species that are appropriate for parking lots. <input type="checkbox"/> Maintain appropriate setbacks from edge of planting strip or island to allow clear sight lines and reduce heat impact on trees (generally 4 feet). <input type="checkbox"/> Maintain an adequate setback between parking stalls and trees to prevent damage from cars. <input type="checkbox"/> Plant large balled and burlapped stock. <input type="checkbox"/> Have a landscape architect design the parking lot planting plan. |
|----------------------------------|--|

| | |
|-----------------------------------|--|
| Specific Planting Guidance | <p><i>Interior</i> Use alternative planting clusters in parking lot islands that allow shared rooting space and provide additional soil volume for trees.</p> <p>Employ “better site design” techniques, which include reducing the size of parking stalls to make the parking lot more efficient and to provide more room for trees (CWP, 1998)</p> <p><i>Perimeter</i> Use trees to provide shade over pedestrian walkways.</p> <p>Maintain a 6- to 8-foot overhead clearance for pedestrian walkways.</p> <p>When planting on steep slopes, use tree clusters and create small earthen berms around the group to retain moisture.</p> <p>When planting along a flatter slope, use linear spacing for safety and functionality</p> |
|-----------------------------------|--|

| | |
|--------------------|---|
| Maintenance | <input type="checkbox"/> Use mulch to retain moisture. <input type="checkbox"/> Plan for minimal maintenance (watering may not be feasible). <input type="checkbox"/> Have trees pruned by a qualified arborist to maintain sight lines and overhead clearance. <input type="checkbox"/> Monitor and control invasive species. |
|--------------------|---|

| | |
|--|---|
| Potential for Storm Water Treatment | <p>Ordinances usually require developers to landscape a minimum percentage of parking lot interiors. When properly built, these landscaped areas can double as storm water treatment facilities, which can result in cost savings for the developer. Storm water forestry practices for parking lots include:</p> <input type="checkbox"/> Parking lot interiors—Bioretention and bioinfiltration facilities, alternating side slope plantings or tree check dams, linear storm water tree pits <input type="checkbox"/> Parking lot perimeters—Bioretention and bioinfiltration facilities, forested filter strips, and multi-zone filter strips <p>See Chapter 3 for more detail on storm water forestry practices.</p> |
|--|---|

Planting Trees in Parking Lots *Continued*

***Further
Resources***

Appleton, B.; Horsley, J.; Harris, V.; Eaton, G.; Fox, L.; Orband, J.; Hoysa, C. 2002. Trees for parking lots and paved areas. In *Trees for problem landscape sites*. Publication No. 430-028. Blacksburg, VA: Virginia Cooperative Extension. www.ext.vt.edu/pubs/trees/430-028/430-028.html.

Center for Urban Forest Research. 2002. Fact Sheet #3: Making parking lots more tree friendly. Davis, CA: USDA Forest Service, Pacific Southwest Research Station. http://cufr.ucdavis.edu/products/CUFR_181_UFfactsheet3.pdf.

Center for Urban Forest Research. 2002. Where are all the cool parking lots? Davis, CA: USDA Forest Service, Pacific Southwest Research Station. http://cufr.ucdavis.edu/products/3/cufr_151.pdf.

Center for Watershed Protection. 1998. *Better site design: a handbook for changing development rules in your community*. Ellicott City, MD.

City of Sacramento, CA. 2003. *Parking lot tree shading design and maintenance guidelines*.

Costello, L. R.; Jones, K. S. 2003. *Reducing infrastructure damage by tree roots: a compendium of strategies*. Cohasset, CA: Western Chapter of the International Society of Arboriculture.

Appendix A. Forest Stand Delineation

This appendix contains the following field sheets, which were created as part of Maryland's Forest Conservation Act requirements, for use in delineating forest stands before developing a site:

- Forest Conservation Worksheet
- Field Sampling Data Sheet
- Explanation of Terms
- Techniques for Forest Structure Data Collection
- Forest Structure Data Sheet
- Forest Structure Analysis
- Forest Stand Summary Sheet.

These field sheets and guidance were originally published in Darr (1991) and were redrawn and/or adapted from Appendix D in the Maryland Forest Conservation Manual (Greenfeld and others 1991). These sheets can be used outside Maryland. See the Maryland manual for further guidance on conducting a Forest Stand Delineation (FSD).

Forest Conservation Worksheet

Input Data

- A. Total site area: _____
B. Area within 100 year floodplain: _____
C. Area of agricultural land (no change in status): _____
D. Net tract area (A – B – C): _____

E. Land use category: _____
F. Afforestation threshold: _____
G. Conservation threshold: _____

H. Current forest cover: _____
I. Forest area above afforestation threshold: _____
J. Forest area above conservation threshold: _____

K. Above conservation threshold to be cleared: _____
L. Below conservation threshold to be cleared: _____
M. Total forested area to be cleared: _____
N. Forested area above conservation threshold to be saved: _____

Calculations

Break-Even Point:

- O. Acres above conservation threshold to be retained for no required reforestation: $J * 20\% =$ _____ acres

Afforestation Requirement:

- P. Forested acres required: $D * F =$ _____
Q. Acres to be afforested: $P - H =$ _____

Reforestation Requirements:

- R. Acres cleared above threshold: $K * \frac{1}{4} =$ _____
S. Acres cleared below threshold: $L * 2 =$ _____
T. Reforestation credit: $N * 1.25 =$ _____
U. Total reforestation requirements: $R + S - T =$ _____ acres

Source: Greenfeld, J.; Herson, L.; Karouna, N.; Bernstein, G. 1991. Forest conservation manual: guidance for the conservation of Maryland's forests during land use changes, under the 1991 Forest Conservation Act. Washington, DC: Metropolitan Washington Council of Governments. Figure D-1, p. D-3.

Field Sampling Data Sheet

Property Name:

Prepared by:

Stand #

Plot #

Date:

| Tree Species (note dominant and co- dominant species) | Size Class of Trees Within the Sample Plot | | | | |
|---|--|------------------------------------|-------------------------------------|-------------------------------------|-----------------------------------|
| | Number of Trees 2-6 in. dbh | Number of Trees 7-10 in. dbh | Number of Trees 11-17 in. dbh | Number of Trees 18-29 in. dbh | Number of Trees >30 in. dbh |
| | | | | | |
| | | | | | |
| | | | | | |
| | | | | | |
| | | | | | |
| | | | | | |
| | | | | | |
| | | | | | |
| | | | | | |
| Number of trees per size class | | | | | |
| List of understory species | | | | | |
| Basal area | | | | | |
| Number of dead trees per plot | | | | | |
| Comments | | | | | |

Source: Greenfeld, J.; Herson, L.; Karouna, N.; Bernstein, G. 1991. Forest conservation manual: guidance for the conservation of Maryland's forests during land use changes, under the 1991 Forest Conservation Act. Washington, DC: Metropolitan Washington Council of Governments. Table D-1, p. D-4.

Explanation of Terms

Forest Stand Information

Stand # – divide the vegetative cover into different stands depending on species groups, size groups, cover types, etc.

Acres – measure the acreage in each separate stand and open areas. Round off to the nearest 1/20 acre.

Species – list the four or five most common, dominant and co-dominant species tallied.

Size class – use the following size classes: 2-6 in. dbh, 7-10 in. dbh, 11-17 in. dbh, 18-29 in. dbh, and greater than 30 in. dbh.

Basal area – this is a density measurement and should be expressed on a per acre basis for each stand.

Number of Trees – count all trees 2 in. dbh or greater occurring on the plot.

Number of Tree Species – count the total number of tree species occurring on the plot.

Number of Dead Trees – count the total number of dead trees occurring on the plot.

Understory Species – record the 3 to 5 most commonly occurring understory species on the plot.

Forest Cover Type – use the Society of American Foresters classification, the Maryland Forest Association Species List, and the species tallied on site to determine this.

Forest Structure Data Sheet

Number of Understory Shrubs – count the total number of shrubs occurring on the plot.

Percent canopy closure – estimate the canopy closure using the method described.

Percent Understory Herbaceous Ground Cover – estimate the herbaceous ground cover using the method described.

Percent Down Woody Debris (greater than 2 inches in diameter) – estimate the amount of dead and down woody debris on the ground using the method described.

Source: Greenfeld, J.; Herson, L.; Karouna, N.; Bernstein, G. 1991. Forest conservation manual: guidance for the conservation of Maryland's forests during land use changes, under the 1991 Forest Conservation Act. Washington, DC: Metropolitan Washington Council of Governments. Table D-2, p. D-5.

Techniques for Forest Structure Data Collection

To measure canopy coverage, herbaceous coverage, dead and downed woody debris, material present and exotic species, it will be necessary to sample in the following way:

1. Construct a sampling tube from a paper towel or toilet paper roll. Attach wires or string on one end of the tube in the configuration of a cross with four evenly spaced openings (see A below).
2. Select one random sampling point within each forest stand. To do this, construct a circular sampling plot of 1/10 acre. Take samples from four points around the circle and one within the circle (see B below).
3. Walk to each sample point and look through the sampling tube at each sample point.
 - a. For canopy coverage, record “yes” or “no” for green seen through the tube when pointed up (tube must be held vertically; count only trees 7 in. dbh and larger).
 - b. For herbaceous coverage, record “yes” or “no” for green seen through the tube when pointed down (tube must be held vertically).
 - c. For dead and down woody material, record “yes” or “no” for any root wads, logs, downed limbs, or bark seen through the tube (tube must be held vertically).
 - d. For exotic or invasive species, record “yes” or “no” for any of these species seen through the tube (tube must be held vertically).
4. Calculate the percentage of sample points at each sample site which were answered by “yes.” Use the above information and additional information provided in the forest stand summary sheet to calculate the forest structure value to be assigned to the site for each individual parameter.
5. Count number of shrubs found within a 1/100-acre plot. Shrubs can be most easily counted if the central stem can be identified.

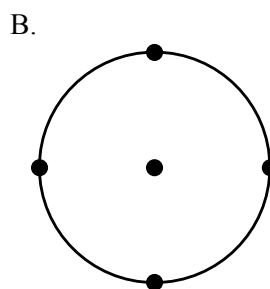
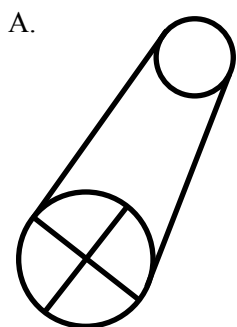

Source: Greenfeld, J.; Herson, L.; Karouna, N.; Bernstein, G. 1991. Forest conservation manual: guidance for the conservation of Maryland's forests during land use changes, under the 1991 Forest Conservation Act. Washington, DC: Metropolitan Washington Council of Governments. Figure D-2, p. D-6.

Forest Structure Data Sheet

Property:

Prepared by:

Stand#:

Plot #:

Date:

| Forest Structure Variable | Sample point 1 | Sample point 2 | Sample point 3 | Sample point 4 | Sample point 5 | % yes |
|--------------------------------------|----------------|----------------|----------------|----------------|----------------|-------|
| Canopy coverage | | | | | | |
| Herbaceous ground cover | | | | | | |
| Downed woody debris | | | | | | |
| Invasive plant cover | | | | | | |
| Number of shrub species (1/100 acre) | | | | | | |

Forest Structure Sampling Method:

1/10-acre plot,
5 sample points

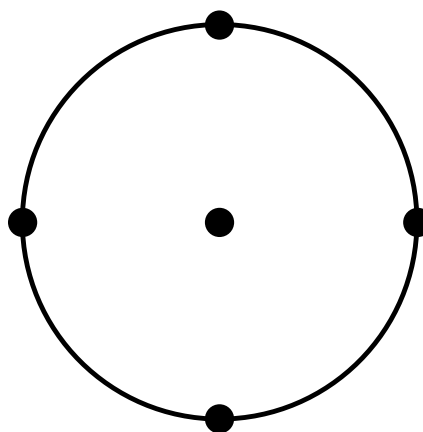

Source: Greenfeld, J.; Herson, L.; Karouna, N.; Bernstein, G. 1991. Forest conservation manual: guidance for the conservation of Maryland's forests during land use changes, under the 1991 Forest Conservation Act. Washington, DC: Metropolitan Washington Council of Governments. Table D-3, p. D-7.

Forest Structure Analysis

The following parameters will be measured and evaluated at each site according to the Techniques for Forest Structure Data Collection. Each parameter at each sample site will be given a value of 3, 2, 1, or 0; 3 represents the most valuable structure and 0 the least valuable. Upon completion of the sampling, the person preparing the forest stand delineation will calculate the forest structure value for each stand. This analysis along with the other forest stand data will be used to determine the retention potential of the stand.

To determine the total habitat value use the following scale:

Range of total habitat numbers from samples taken April – October:

15-21 Priority forest structure
 7-14 Good forest structure
 0-6 Poor forest structure

In the winter and late fall, from November – March, only numbers 1, 3, 4, 5, 7 can be measured. During that time, the range of total habitat numbers will be:

11 – 15 Priority forest structure
 6 – 10 Good forest structure
 0 – 5 Poor forest structure

| | | | |
|---|---|--|---|
| 1. Percent Canopy Closure of trees with a dbh greater than 7 inches | | 5. Size Class of Dominant Trees | |
| 70% - 100% | 3 | Greater than 20 inches | 3 |
| 40% - 69% | 2 | 7 in. - 19.9 in. | 2 |
| 10% - 39% | 1 | 3 in. - 6.9 in. | 1 |
| 0% - 9% | 0 | Less than 3 in. | 0 |
| 2. Number of Understory Shrubs per 1/100 acre | | 6. Percent of Understory Herbaceous Coverage | |
| 6 or more | 3 | 75% - 100% | 3 |
| 4 - 5 | 2 | 25% - 74% | 2 |
| 2 - 4 | 1 | 5% - 24% | 1 |
| 0 - 1 | 0 | 0% - 4% | 0 |
| 3. Number of Dead Trees per 1/10-acre plot | | 7. Number of Tree Species with a dbh greater than 7 in. per plot | |
| 3 or more | 3 | 6 or more | 3 |
| 2 | 2 | 4 - 5 | 2 |
| 1 | 1 | 2 - 4 | 1 |
| 0 | 0 | 0 - 1 | 0 |
| 4. Percent of Dead and Downed Woody Material Present | | | |
| 15% - 100% | 3 | | |
| 5 in. - 14 in. | 2 | | |
| 0-1 | 1 | | |
| 0 | 0 | | |

Source: Greenfeld, J.; Herson, L.; Karouna, N.; Bernstein, G. 1991. Forest conservation manual: guidance for the conservation of Maryland's forests during land use changes, under the 1991 Forest Conservation Act. Washington, DC: Metropolitan Washington Council of Governments. Figure D-3, p. D-8.

Forest Stand Summary Sheet

Property Name:

Prepared by:

Date:

| Stand Variable | Stand # | Acreage | Stand # | Acreage |
|--|---------|---------|---------|---------|
| Forest Association (SAF cover type) | | | | |
| Size class of dominant trees | | | | |
| Number of trees/acre | | | | |
| Number of tree species/plot | | | | |
| Basal area | | | | |
| Number of dead trees/acre | | | | |
| List of common understory species | | | | |
| | | | | |
| Number of shrubs 1/100 acre plot | | | | |
| Percent canopy coverage | | | | |
| Percent herbaceous cover | | | | |
| Percent downed woody material | | | | |
| Percent exotic or invasive species | | | | |
| Forest Structure Value | | | | |
| Comments | | | | |

Source: Greenfeld, J.; Herson, L.; Karouna, N.; Bernstein, G. 1991. Forest conservation manual: guidance for the conservation of Maryland's forests during land use changes, under the 1991 Forest Conservation Act. Washington, DC: Metropolitan Washington Council of Governments. Table D-4, p. D-9.

Appendix B. Tree Protection Specifications

This appendix contains specifications for the following tree protection techniques, for use during construction:

- Blaze orange plastic mesh
- Three strand barbed wire
- Snow fence
- Signage
- Filter cloth on wire mesh
- Staked straw bale dike
- Earthen dike and swale.

These specifications were originally published in Darr (1991) and were redrawn and/or adapted from Appendix J in the Maryland Forest Conservation Manual (Greenfeld and others, 1991). These techniques and specifications can be used outside Maryland. See the Maryland manual for more information on using these techniques.

Blaze Orange Plastic Mesh

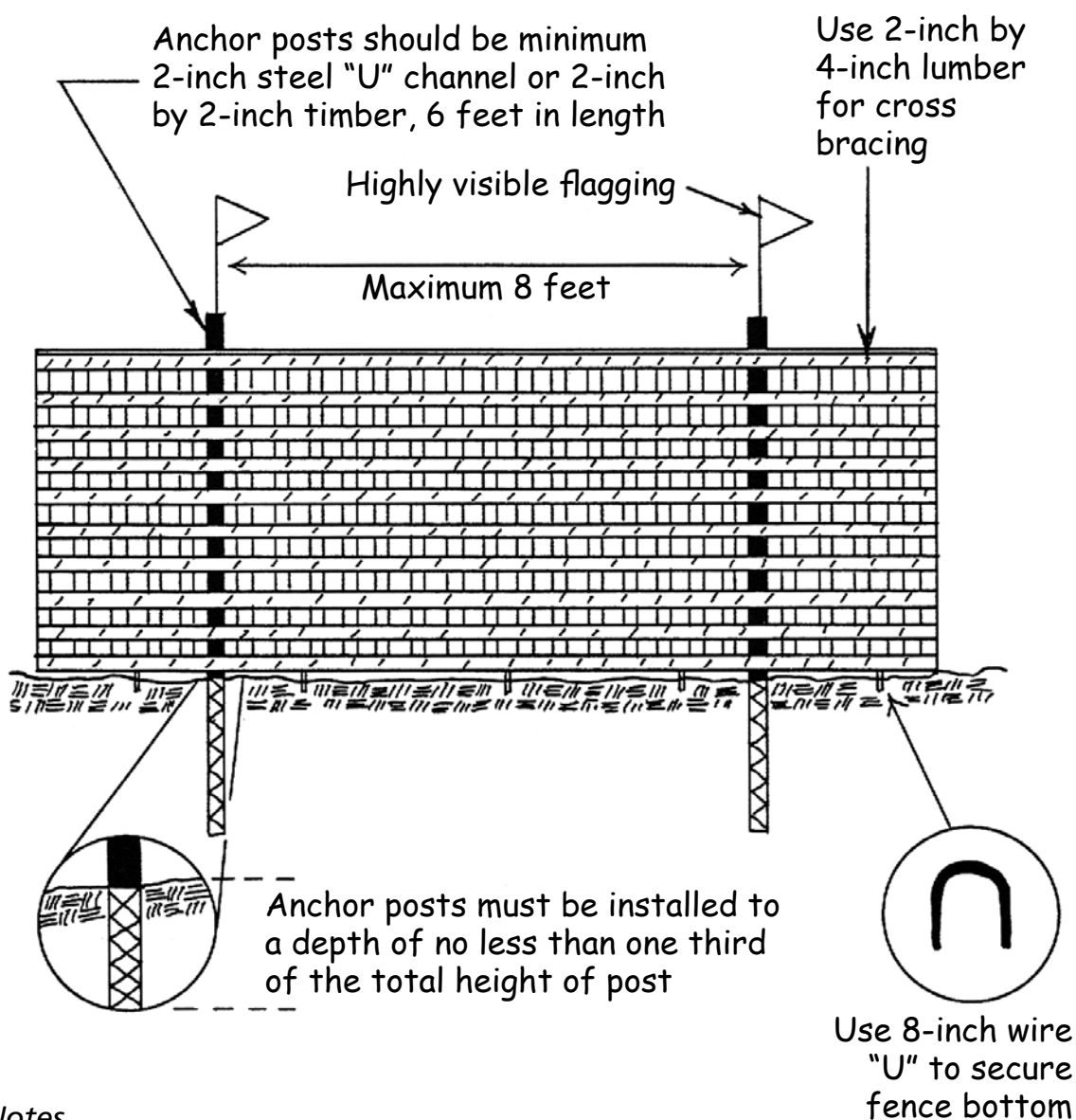

Notes

1. Forest protection device only.
2. Retention Area will be set as part of the review process.
3. Boundaries of Retention Area should be staked and flagged prior to installing device.
4. Root damage should be avoided.
5. Protective signage may also be used.
6. Device should be maintained throughout construction.

Source: Greenfeld, J.; Herson, L.; Karouna, N.; Bernstein, G. 1991. Forest conservation manual: guidance for the conservation of Maryland's forests during land use changes, under the 1991 Forest Conservation Act. Washington, DC: Metropolitan Washington Council of Governments. Figure J-4, p. J-6.

Three Strand Barbed Wire

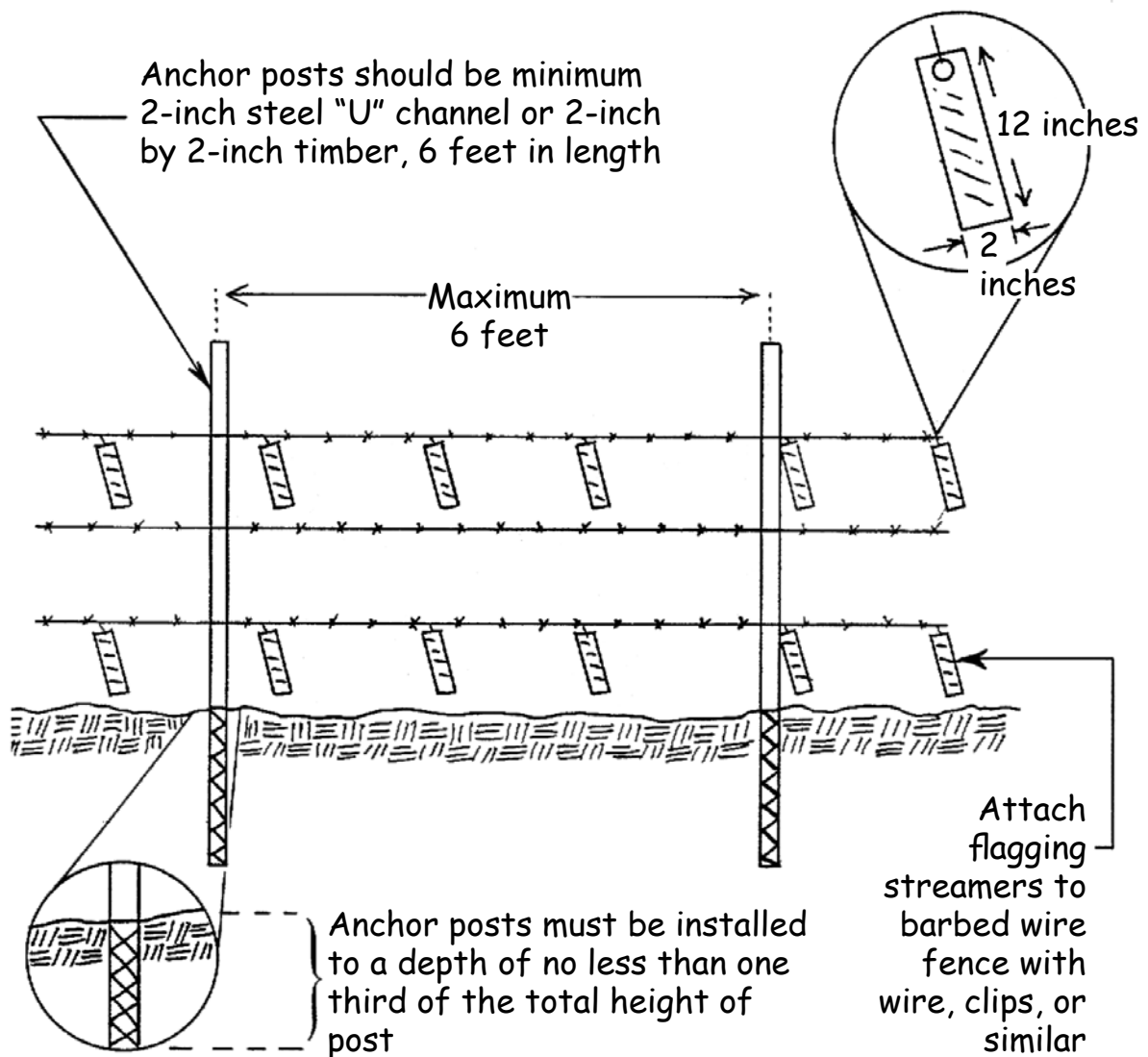

Notes

1. Forest protection device only.
2. Retention Area will be set as part of the review process.
3. Boundaries of Retention Area should be staked and flagged prior to installing device.
4. Avoid root damage when placing anchor posts.
5. Barbed wire should be securely attached to posts.
6. Device should be properly maintained during construction.
7. Protective signage is also recommended.

Source: Greenfeld, J.; Herson, L.; Karouna, N.; Bernstein, G. 1991. Forest conservation manual: guidance for the conservation of Maryland's forests during land use changes, under the 1991 Forest Conservation Act. Washington, DC: Metropolitan Washington Council of Governments. Figure J-5, p. J-7.

Snow Fence

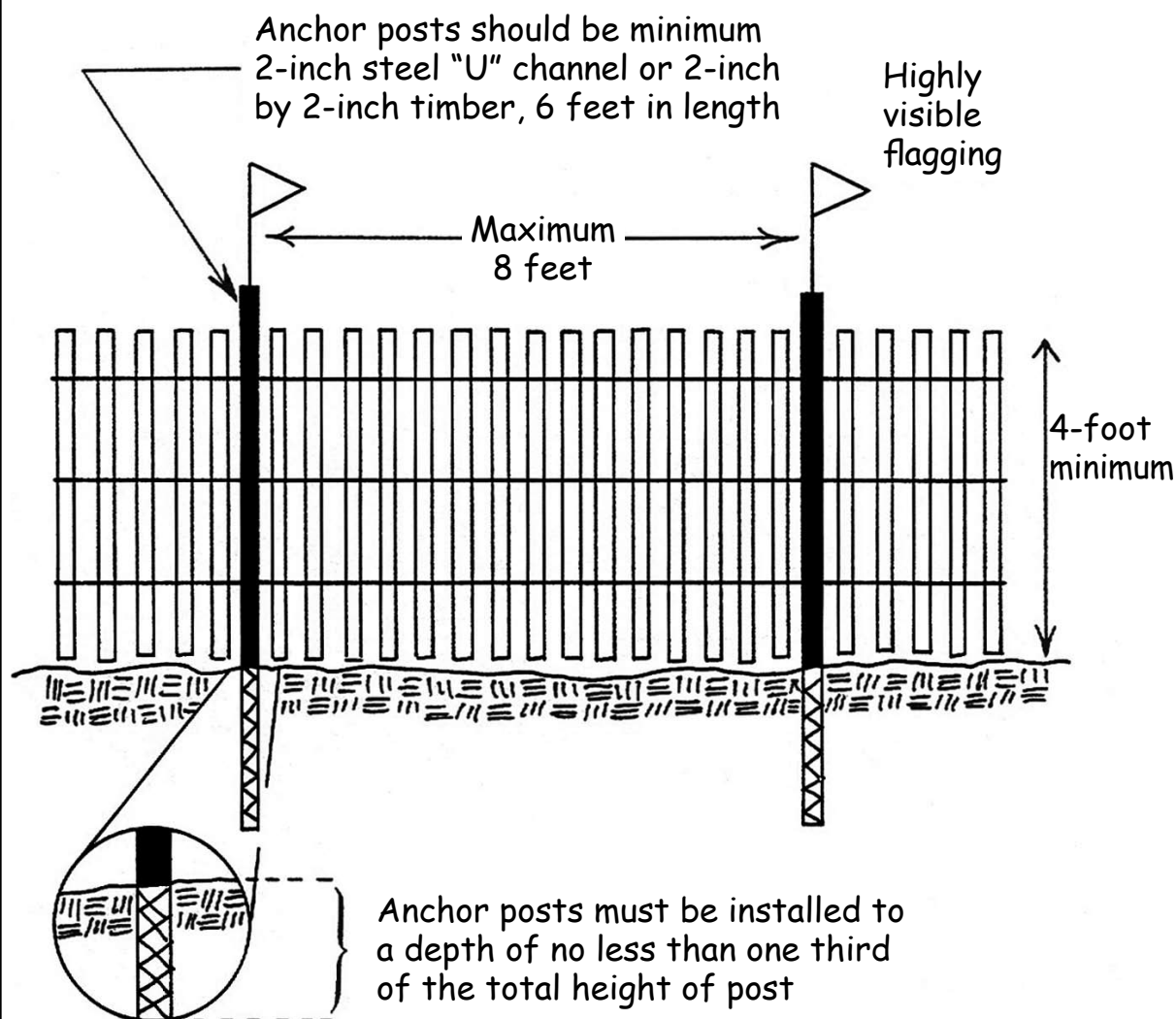

Notes

1. Forest protection device only.
2. Retention Area will be set as part of the review process.
3. Boundaries of Retention Area should be staked prior to installing protective device.
4. Avoid root damage when placing anchor posts.
5. Device should be properly maintained during construction.
6. Protective signage is also recommended.

Source: Greenfeld, J.; Herson, L.; Karouna, N.; Bernstein, G. 1991. Forest conservation manual: guidance for the conservation of Maryland's forests during land use changes, under the 1991 Forest Conservation Act. Washington, DC: Metropolitan Washington Council of Governments. Figure J-6, p. J-8.

Signage



Source: Greenfeld, J.; Herson, L.; Karouna, N.; Bernstein, G. 1991. Forest conservation manual: guidance for the conservation of Maryland's forests during land use changes, under the 1991 Forest Conservation Act. Washington, DC: Metropolitan Washington Council of Governments. Figure J-7, p. J-9.

Filter Cloth on Wire Mesh

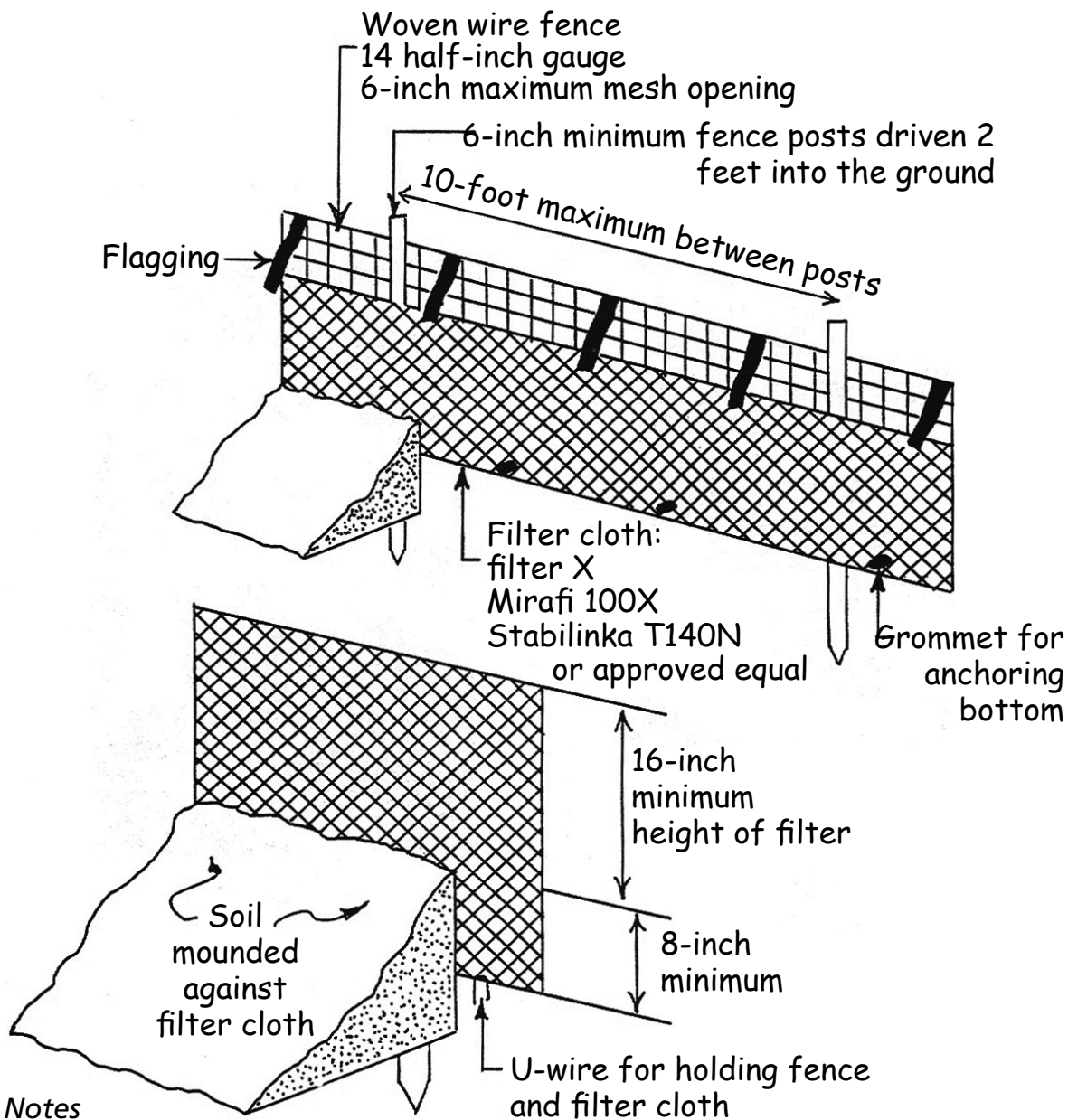

Notes

1. Combination sediment control and protective device.
2. Retention Area will be set as part of the review process.
3. Boundaries of Retention Area should be staked prior to installing protective device.
4. Root damage should be avoided.
5. Mound soil only within the limits of disturbance.
6. Protective signage is also recommended.
7. All standard maintenance for sediment control devices applies to these details.

Source: Greenfeld, J.; Herson, L.; Karouna, N.; Bernstein, G. 1991. Forest conservation manual: guidance for the conservation of Maryland's forests during land use changes, under the 1991 Forest Conservation Act. Washington, DC: Metropolitan Washington Council of Governments. Figure J-8, p. J-10.

Staked Straw Bale Dike

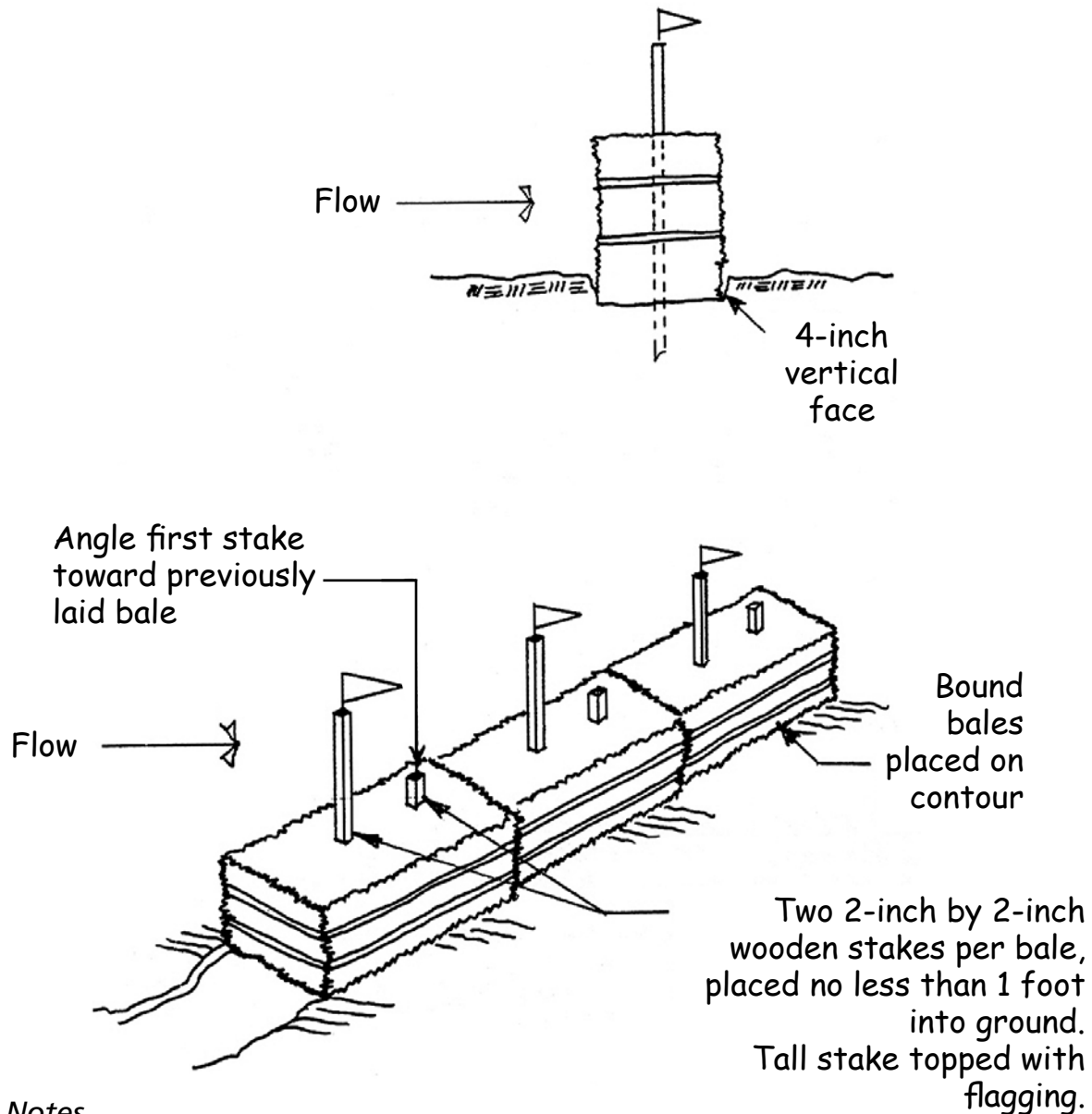

Notes

1. Combination sediment control and protective device.
2. Retention Area will be set as part of the review process.
3. Boundaries of Retention Area should be staked prior to installing protective device.
4. Root damage should be avoided.
5. This device should only be placed within the limit of disturbance.
6. Protective signage is also recommended.
7. All standard maintenance for sediment control devices applies to these details.

Source: Greenfeld, J.; Herson, L.; Karouna, N.; Bernstein, G. 1991. Forest conservation manual: guidance for the conservation of Maryland's forests during land use changes, under the 1991 Forest Conservation Act. Washington, DC: Metropolitan Washington Council of Governments. Figure J-9, p. J-11.

Earthen Dike and Swale

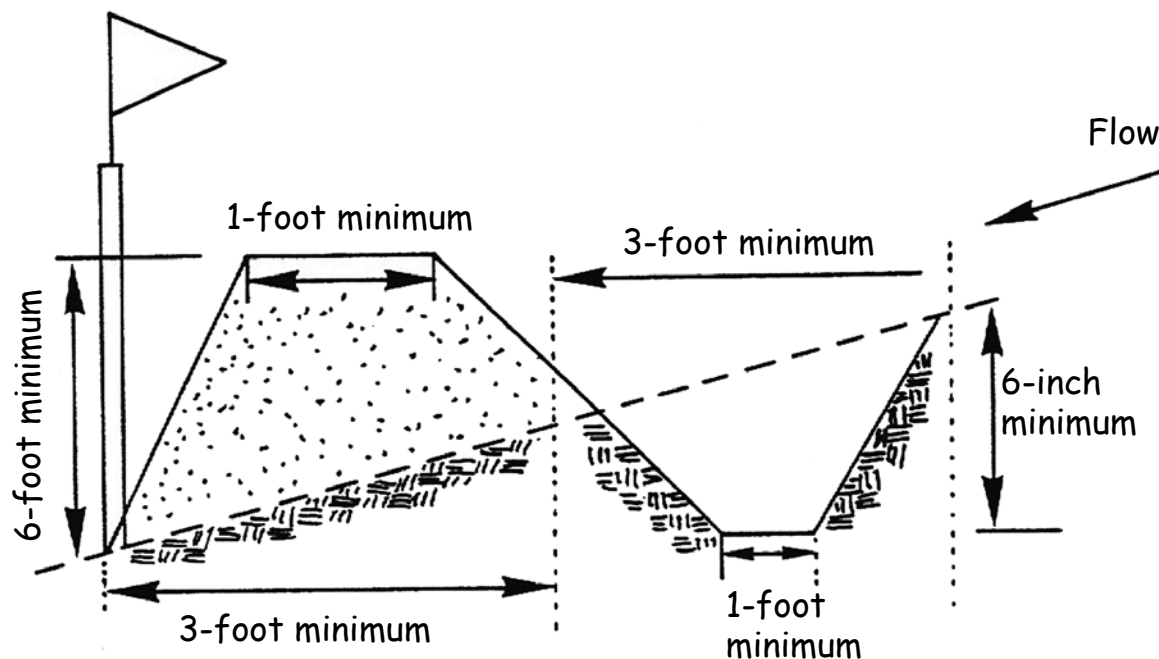

Notes

1. Combination sediment control and protective device.
2. Retention Area will be set as part of the review process.
3. Boundaries of Retention Area should be staked prior to installing protective device.
4. Root damage should be avoided.
5. The top or toe of slope should be within the limit of disturbance.
6. Equipment is prohibited within critical root zone of retention area; place dike accordingly.
7. All standard maintenance for earthen dikes and swales applies to these details.
8. All standard reclamation practices for earthen dikes and swales shall apply to these details.

Source: Greenfeld, J.; Herson, L.; Karouna, N.; Bernstein, G. 1991. Forest conservation manual: guidance for the conservation of Maryland's forests during land use changes, under the 1991 Forest Conservation Act. Washington, DC: Metropolitan Washington Council of Governments. Figure J-10, p. J-12.

References

- Akbari, H.; Davis, S.; Dorsano, S.; Huang, J.; Winnett, S., eds. 1992. Cooling our communities: a guidebook on tree planting and light-colored surfacing. 22P-2001. Washington, DC: U.S. Environmental Protection Agency. 217 p.
- Anderson, L. M.; Cordell, H. K. 1988. Influence of trees on residential property values in Athens, Georgia: a survey based on actual sales prices. *Landscape and Urban Planning* 15: 1-2, 153-164.
- Appleton, B.; Horsley, J.; Harris, V.; Eaton, G.; Fox, L.; Orband, J.; Hoysa, C. 2002. Trees for parking lots and paved areas. In: *Trees for problem landscape sites*. Publication No. 430-028. Blacksburg, VA: Virginia Cooperative Extension. 4 p. www.ext.vt.edu/pubs/trees/430-028/430-028.html (Accessed December 28, 2005).
- Arendt, R. G. 1996. Conservation design for subdivisions. A practical guide to creating open space networks. Washington, DC: Island Press. 184 p.
- Bassuk, N.; Curtis, D. F.; Marranta, B. Z.; Neal, B. 2003. Recommended urban trees: site assessment and tree selection for stress tolerance. Ithaca, NY: Cornell University, Urban Horticulture Institute. 127 p. www.hort.cornell.edu/uhi (Accessed December 28, 2005).
- Bassuk, N.; Grabosky, J.; Trowbridge, P.; Urban, J. [N.d.]. Structural soil: an innovative medium under pavement that improves street tree vigor. Ithaca, NY: Cornell University, Urban Horticulture Institute. 2 p. www.hort.cornell.edu/departments/faculty/bassuk/uhi/outreach/csc/article.html (Accessed December 28, 2005).
- Center for Urban Forest Research. 2001. Fact Sheet #1: Benefits of the urban forest. Davis, CA: USDA Forest Service, Pacific Southwest Research Station. 2 p. http://cufr.ucdavis.edu/products/cufr_179_UFfactsheet1.pdf (Accessed December 28, 2005).
- Center for Watershed Protection. 1998. Better site design: a handbook for changing development rules in your community. Ellicott City, MD. 174 p.
- Center for Watershed Protection. 2003. Impacts of impervious cover on aquatic systems. Watershed Protection Research Monograph No. 1. Ellicott City, MD. 142 p.
- City of Portland, OR. 2004. Stormwater management manual. Bureau of Environmental Services. 268 p.
- Coder, K. 1994. Flood damage to trees. Athens, GA: University of Georgia, Warnell School of Forest Resources. 5 p. <http://warnell.forestry.uga.edu/warnell/service/library/for94-061/for94-061.pdf> (Accessed December 28, 2005).
- Coder, K. 1995. Tree quality BMPs for developing wooded areas and protecting residual trees. In: Watson, G. W.; Neely, D., eds. *Trees and building sites*. 1995. Champaign, IL: International Society of Arboriculture. 111-124.

Urban Watershed Forestry Manual - Part 2

Coder, K. 1996. Identified benefits of community trees and forests. Athens, GA: University of Georgia. www.scenicflorida.org/lsctreebenefits.html (Accessed December 28, 2005).

Coder, K. 1999. Drought damage to trees. Athens, GA: University of Georgia, Warnell School of Forest Resources. 5 p. <http://warnell.forestry.uga.edu/warnell/service/library/for99-010/for99-010.pdf> (Accessed December 28, 2005).

Cornell University. 2004. Conducting a street tree inventory. Ithaca, NY: Cornell University, Department of Horticulture. www.hort.cornell.edu/commfor/inventory/index.html (Accessed December 28, 2005).

Correll, M.; Lillydahl, J.; Singell, L. 1978. The effects of greenbelts on residential property values: some findings on the political economy of open space. *Land Economics* 54: 207-217.

Craul, P. J. [N.d.]. Urban soils. Syracuse, NY: State University of New York, College of Environmental Science and Forestry. 17 p. www.ces.ncsu.edu/fletcher/programs/nursery/metria/metria5/m57.pdf (Accessed December 28, 2005).

CUFR—see Center for Urban Forest Research

CWP—see Center for Watershed Protection

Darr, L. 1991. A technical manual for woodland conservation with development in Prince George's County. Silver Spring, MD: Maryland-National Capital Parks and Planning Commission, Planning Department, Natural Resources Division.

EPA—see U.S. Environmental Protection Agency

Ferguson, B. K. 1994. Stormwater infiltration. Boca Raton, FL: CRC Press, Inc. 288 p.

Foster, R. S. 1978. Bio-Engineering for the Urban Ecosystem. *Metropolitan Tree Improvement Alliance Proceedings* 1:13-17.

Genua, S. M. 2000. Converting power easements into butterfly habitats. Washington, DC: Potomac Electric Power Company (PEPCO). www.butterflybreeders.org/pages/powerease_sg.html (Accessed December 28, 2005).

Georgia Forestry Commission. 2001. Georgia model urban forest book. Macon, GA. 78 p.

GFC—see Georgia Forestry Commission

Greenfield, J.; Herson, L.; Karouna, N.; Bernstein, G. 1991. Forest conservation manual: guidance for the conservation of Maryland's forests during land use changes, under the 1991 Forest Conservation Act. Washington, DC: Metropolitan Washington Council of Governments. 122 p.

Hammerschlag, R. S.; Sherald, J. L. 1985. Traditional and expanded tree pit concepts. In: METRIA 5: Selecting and Preparing Sites for Urban Trees. *Proceedings of the Fifth Conference of the Metropolitan Tree Improvement Alliance*. University Park, PA: The Pennsylvania State University. 33-44.

References

- Harris, R.W. 1992. *Arboriculture: integrated management of landscape trees, shrubs, and vines*. Englewood Cliffs, NJ: Prentice Hall. 687 p.
- Heat Island Group. 1996. *Working to cool urban heat islands*. Berkeley, CA: Berkeley National Laboratory. 3 p.
- Heisler, G. M. 1986. Energy savings with trees. *Journal of Arboriculture* 12: 113-124.
- Heisler, G. M. 1989. *Site design and microclimate research*. USDA Forest Service, Northeast Forest Experiment Station, University Park, PA.
- Johnson, G. R. 2005. *Protecting trees from construction damage: a homeowner's guide*. St. Paul, MN: Regents of the University of Minnesota.
www.extension.umn.edu/distribution/housingandclothing/DK6135.html (Accessed December 28, 2005).
- Kitchen, J.; Hendon, W. 1967. Land values adjacent to an urban neighborhood park. *Land Economics* 43: 357-360.
- Licht, L. A. 1990. Poplar tree roots for water quality improvement. In *Proceedings of National Conference on Enhancing State's Lake Management Programs*. Chicago, IL: U.S. Environmental Protection Agency. 55-61.
- Maryland Department of Natural Resources. [N.d.]. *Maryland's forests: a health report*. Annapolis, MD: Forest Service. www.dnr.state.md.us/forests/healthreport (Accessed December 28, 2005).
- Maryland National Capital Parks and Planning Commission. 1992. *Trees*. Approved Technical Manual. Maryland National Capital Parks and Planning Commission, Montgomery County, MD. 144 p.
www.mc-mncppc.org/environment/forest/trees/detail_trees.pdf (Accessed December 28, 2005).
- McPherson, E. G. 1998. Shade trees and parking lots. *Arid Zone Times* February:1-2.
- MD DNR—see Maryland Department of Natural Resources
- Metro. 2002. *Green streets: innovative solutions for stormwater and stream crossings*. Portland, OR. 144 p.
- Meyer, P. W. [N.d.]. Alternatives to linear street tree plantings. In: *METRIA 5: Selecting and Preparing Sites for Urban Trees*. Proceedings of the Fifth Conference of the Metropolitan Tree Improvement Alliance. University Park, PA: The Pennsylvania State University. 28-32.
- Minnesota Department of Natural Resources. 2000. *Conserving wooded areas in developing communities. BMPs in Minnesota*. Minnesota Department of Natural Resources, St. Paul, MN. 113 p.
www.dnr.state.mn.us/forestry/urban/bmps.html (Accessed December 28, 2005).
- MN DNR—see Minnesota Department of Natural Resources
- MNCPPC—see Maryland National Capital Parks and Planning Commission

Urban Watershed Forestry Manual - Part 2

- Morales, D. J. 1980. The contribution of trees to residential property value. *Journal of Arboriculture* 6: 305-308.
- Morales, D. J.; Micha, F. R.; Weber, R. L. 1983. Two methods of valuating trees on residential Sites. *Journal of Arboriculture* 9: 21-24.
- More, T. A.; Allen, P. G.; Stevens, T. H. 1983. Economic valuation of urban open-space resources. In: *America's hardwood forests--opportunities unlimited: Convention of the Society of American Foresters; 1982 September 19-22. SAF Publication 83-04. Bethesda, MD: Society of American Foresters. 336-339.*
- Nowak, D. J.; Kuroda, M.; Crane, D. E. 2004. Tree mortality rates and tree population projections in Baltimore, Maryland, USA. *Urban Forestry and Urban Greening* 2: 139-147.
www.fs.fed.us/ne/newtown_square/publications/other_publishers/OCR/ne_2004nowak01.pdf
(Accessed December 28, 2005).
- Parker, J. H. 1983. Landscaping to reduce the energy used in cooling buildings. *Journal of Forestry* 81: 82-83.
- Pennsylvania State University. 1999. A guide to preserving trees in development projects. University Park, PA: Penn State College of Agricultural Sciences, Cooperative Extension. 27 p.
- Prince George's County. 2001. Bioretention manual. Upper Marlboro, MD: Department of Environmental Resources Program and Planning Division. 149 p.
- PSU—see Pennsylvania State University
- Schueler, T. R. 1995. Site planning for urban stream protection. Ellicott City, MD: Center for Watershed Protection. 232 p.
- Schueler, T. R. 2000. The economics of watershed protection. In: Schueler, T. R.; Holland, H. K., eds. *The Practice of Watershed Protection*. Ellicott City, MD: Center for Watershed Protection. Article 30. 171-182.
- Scott, K. I.; Simpson, J. R.; McPherson, E. G. 1998. Green parking lots: Can trees improve air quality? *California Urban Forests Council Newsletter Spring 1998*: 1-2.
http://cufr.ucdavis.edu/products/cufr_71_SK98_77.PDF (Accessed December 28, 2005).
- Shaw, D.; Schmidt, R. 2003. Plants for stormwater design. Species selection for the Upper Midwest. St. Paul, MN: Minnesota Pollution Control Agency. 369 p.
- Stormcenter Communications, Inc. 2003. A recipe for ozone. *Envirocast Weather and Watershed Newsletter* 1(11). www.stormcenter.com/envirocast/2003-09-25/feature.html (Accessed December 28, 2005).
- Sullivan, W. C.; Kuo, F. E. 1996. Do trees strengthen urban communities, reduce domestic violence? *Technology Bulletin R8-FR56*. Atlanta, GA: USDA Forest Service, Southern Region, Southern Station, and Northeastern Area State and Private Forestry. 4 p.

References

- Trees Atlanta. [N.d.]. Facts. Atlanta, GA. www.treesatlanta.org/facts.html (Accessed December 28, 2005).
- Ulrich, P. S. 1984. View through a window may influence recovery from surgery. *Science* 224: 420-421.
- University of Washington. 1998. Trees in business districts: positive effects on consumer behavior! Seattle, WA: University of Washington, College of Forest Resources, Center for Urban Horticulture. 2 p.
- Urban, J. 1999. Room to grow. *Treelink* 11: 1-4.
- USACE—see U.S. Army Corps of Engineers
- U.S. Army Corps of Engineers. 1989. Retaining and flood walls. Engineer Manual No. 1110-2-2502. Washington, DC. 447 p.
- U.S. Environmental Protection Agency. 1998. A citizen's guide to phytoremediation. EPA 542-F-98-011. Washington, DC: Office of Solid Waste and Emergency Response. 2 p.
- USDA Forest Service. 1998. Volunteer training manual. Amherst, MA: Northeast Center for Urban and Community Forestry. 86 p. www.umass.edu/urbantree/volmanual.pdf (Accessed December 28, 2005).
- Weyerhaeuser Company. 1989. The value of landscaping. Tacoma, WA: Weyerhaeuser Nursery Products Division.
- WHEC—see Wildlife Habitat Enhancement Council
- Wildlife Habitat Enhancement Council. 1992. The economic benefits of wildlife habitat enhancement on corporate lands. Silver Spring, MD: Wildlife Habitat Enhancement Council. 22 p.
- Winer, R. W. 2000. Pollutant removal database, 2nd ed. Ellicott City, MD: Center for Watershed Protection. 29 p.
- Yu, S.; Barnes, S.; Gedde, V. 1993. Testing of best management practices for controlling highway runoff. FWHA/VA 93-R16. Charlottesville, VA: Virginia Transportation Research Council. 62 p.

The U.S. Department of Agriculture (USDA) prohibits discrimination in all its programs and activities on the basis of race, color, national origin, age, disability, and where applicable, sex, marital status, familial status, parental status, religion, sexual orientation, genetic information, political beliefs, reprisal, or because all or part of an individual's income is derived from any public assistance program. (Not all prohibited bases apply to all programs.) Persons with disabilities who require alternative means for communication of program information (Braille, large print, audiotape, etc.) should contact USDA's TARGET Center at (202) 720-2600 (voice and TDD). To file a complaint of discrimination, write to USDA, Director, Office of Civil Rights, 1400 Independence Avenue, S.W., Washington, D.C. 20250-9410, or call (800) 795-3272 (voice) or (202) 720-6382 (TDD). USDA is an equal opportunity provider and employer.

