

INDOT Civil Cells

References (6-1-2016)

1. T-INTERSECTIONS

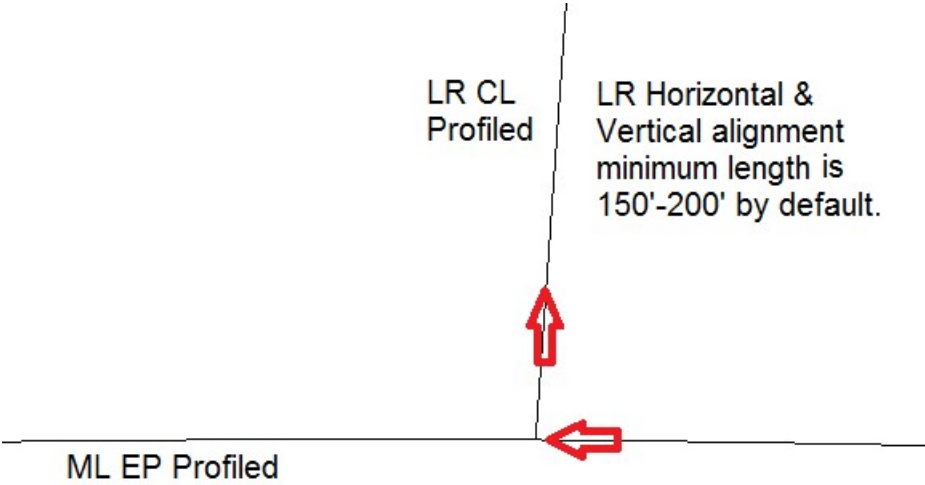

2. CURB RAMPS

Perpendicular & Diagonal

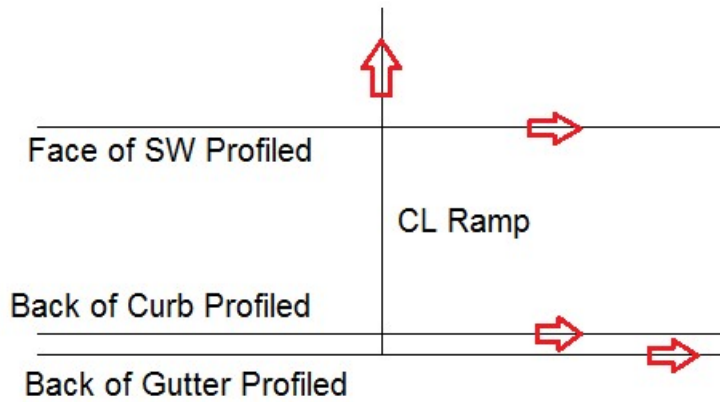

Parallel & Blended

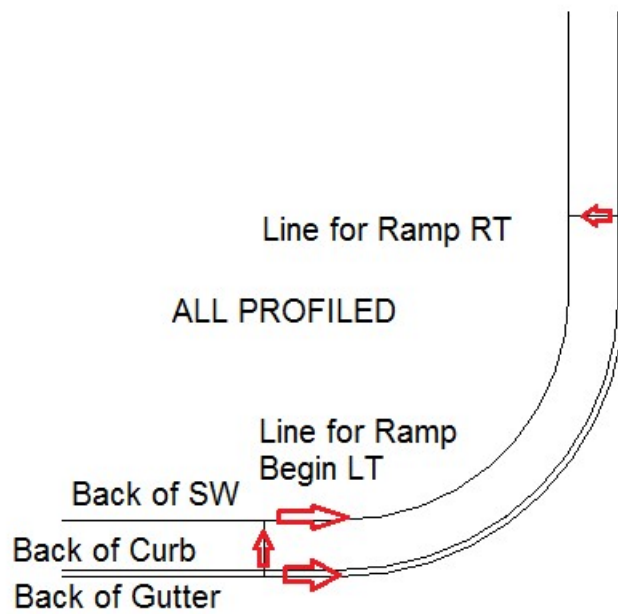

One-Way

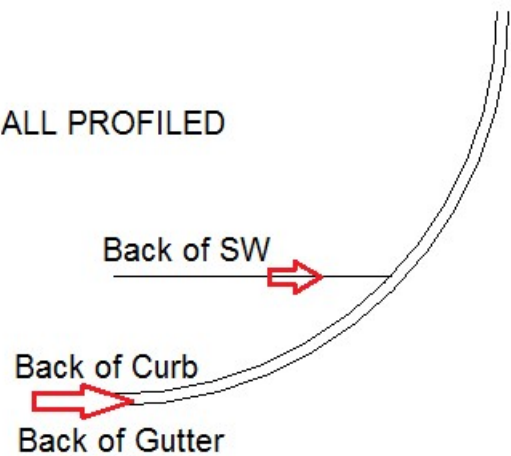

Depressed Corner

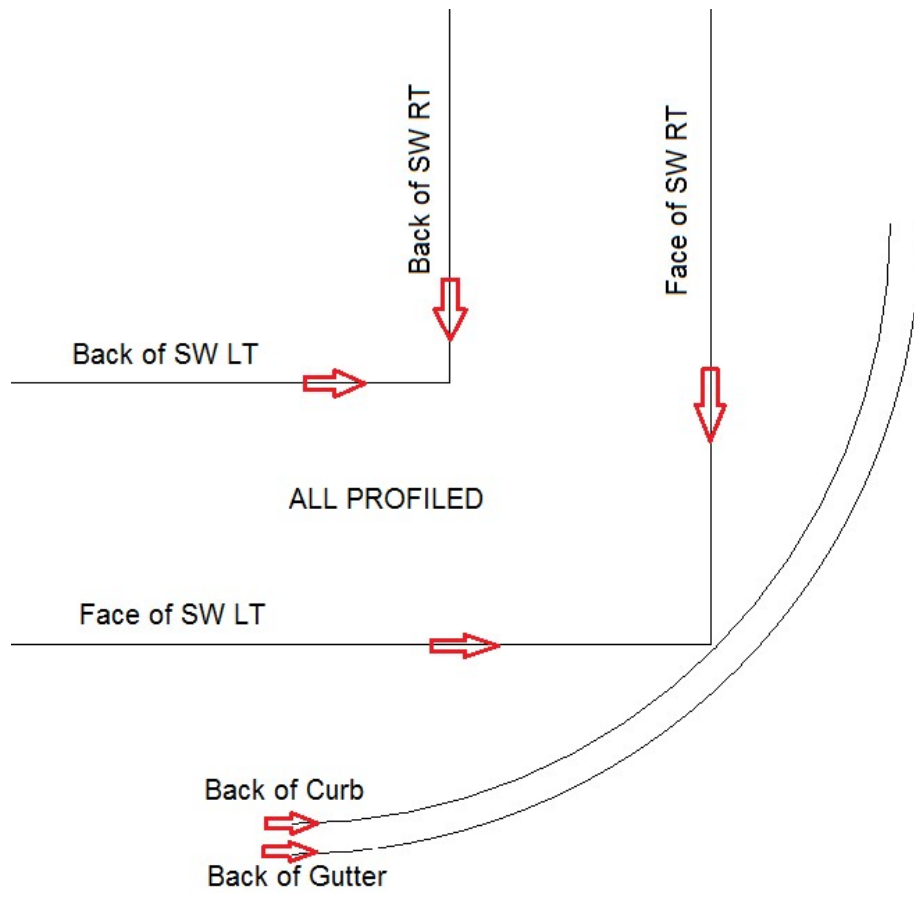

3. BRIDGE/GUARDRAIL

Permanent Cross-Overs

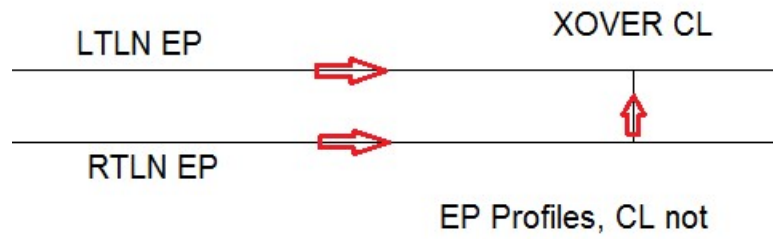

Temporary Type A

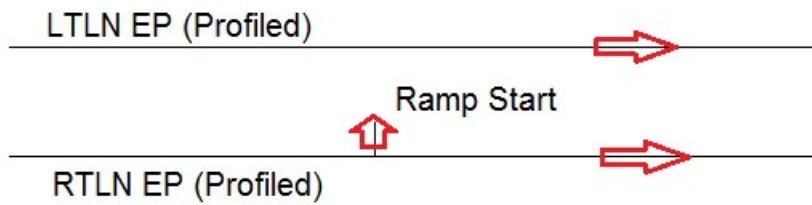

4. BRIDGE

Embankment

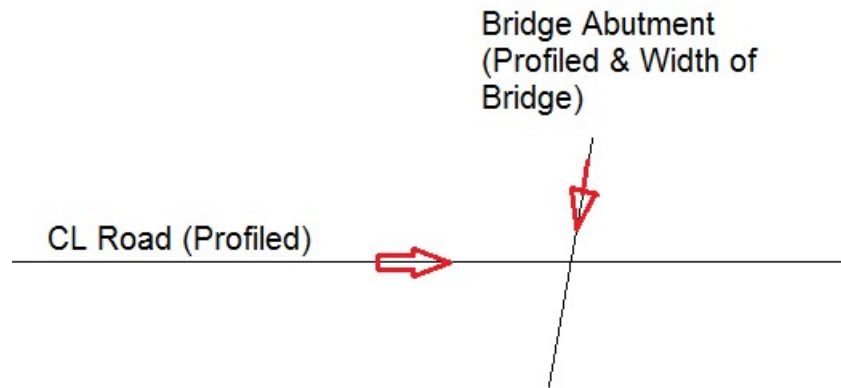

GRET

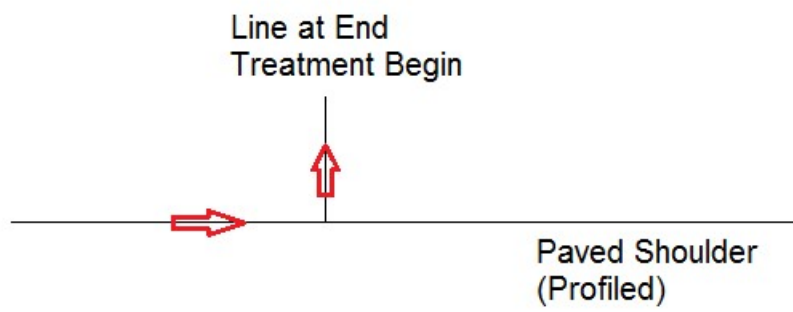

5. BOX CULVERT

Box Culvert

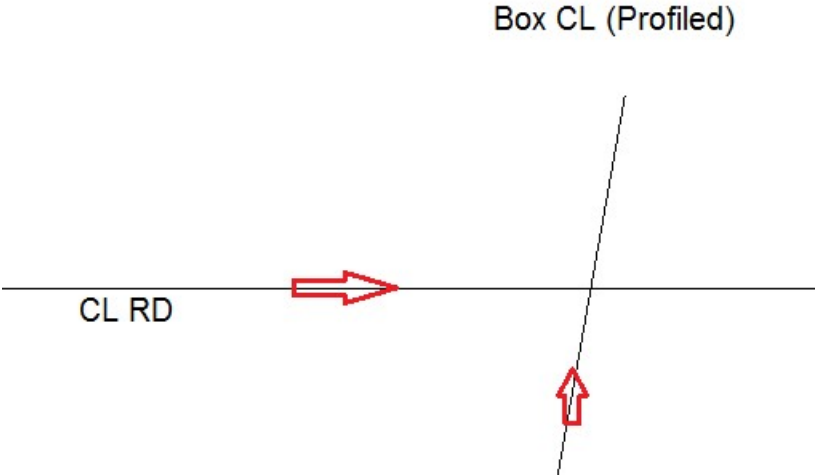

6. DETOUR

Detours

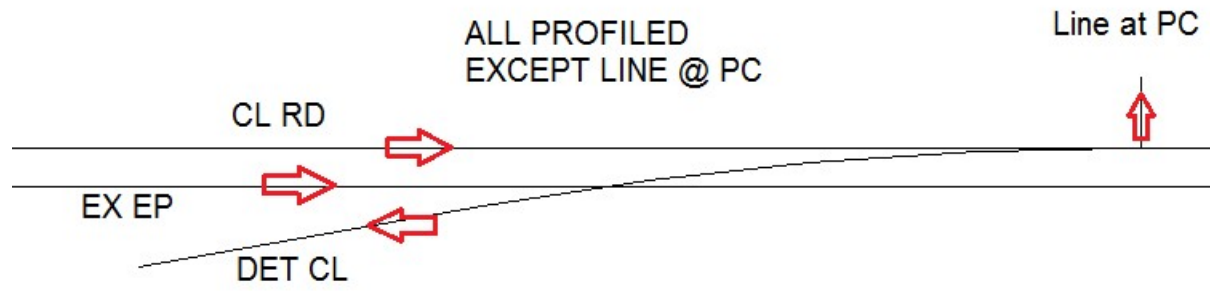

7. INTERCHANGE RAMPS

IR Ramps Parallel



8. Drives & Mailbox approaches

MailBox Approach

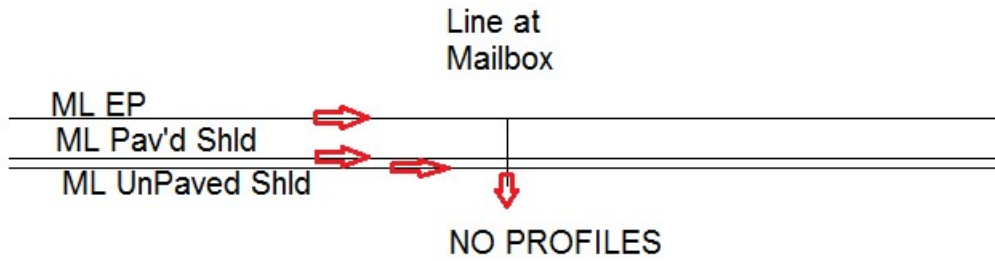

Drives

