

TABLE OF CONTENTS

TABLE OF CONTENTS	1
List of Figures	3
75-2C Sign Gore Treatment.....	3
75-2D Sign Types.....	3
75-4A Suggested Minimum Distances for Placement of Advance Warning Signs	3
75-4B Conditions for Placement of Advance Warning Signs	3
75-4C Ball-Bank Indicator Readings	3
75-5A Regional Control Cities for Indiana Interstates.....	3
75-5B National Control Cities for Indiana Interstates	3
75-5C Guidelines for Signing Traffic Generators on Freeways.....	3
75-5D Typical Crossroad Signing at Freeway Interchanges	3
75-5E Diamond Interchange Signing (Freeway Under Divided Highway).....	3
75-5F Diamond Interchange Signing (Freeway Over Divided Highway).....	3
75-5G Diamond Interchange Signing (Freeway Under Undivided Highway).....	3
75-5H Diamond Interchange Signing (Freeway Over Undivided Highway).....	3
75-5 I Full Cloverleaf Interchange Signing (Freeway Under Divided Highway).....	3
75-5J Full Cloverleaf Interchange Signing (Freeway Over Divided Highway).....	3
75-5K Full Cloverleaf Interchange Signing (Freeway Under Undivided Highway).....	3
75-5L Full Cloverleaf Interchange Signing (Freeway Over Undivided Highway).....	3
75-5M Partial Cloverleaf Interchange Signing (Freeway Under Divided Highway).....	3
75-5N Partial Cloverleaf Interchange Signing (Freeway Over Divided Highway).....	3
75-5 O Partial Cloverleaf Interchange Signing (Freeway Under Undivided Highway).....	3
75-5P Partial Cloverleaf Interchange Signing (Freeway Over Undivided Highway).....	3
75-5Q Trumpet Interchange Signing System (One Road Terminates)	3
Chapter Seventy-five.....	4
75-1.0 MUTCD CONTEXT	4
75-2.0 GENERAL CRITERIA	4
75-2.01 References.....	5
75-2.02 Reflectorization	5
75-2.03 Illumination	6
75-2.04 Sign Placement	6
75-2.05 Roadside Safety	8
75-2.06 Overhead Panel Sign.....	9
75-2.07 Sign Priority.....	10
75-2.08 Computer Software.....	11
75-2.09 Symbology	11
75-2.10 Structural Design	11

- 75-2.11 Applications..... 12
- 75-3.0 REGULATORY SIGNS..... 12
 - 75-3.01 Official Action..... 12
 - 75-3.02 “Stop” or “Yield” Sign 12
 - 75-3.02(01) General..... 12
 - 75-3.02(02) Multiway Stop Control..... 13
 - 75-3.02(03) Stop Sign at Railroad Crossing 13
 - 75-3.03 Speed Limit Sign 13
 - 75-3.04 “No U-Turn” Sign..... 14
 - 75-3.05 Lane-Use Control Signs at Intersection 14
 - 75-3.06 “Right Turn Only” Sign..... 14
 - 75-3.07 Two-Way Left Turn Only (TWLTO) Signs 15
 - 75-3.08 “No Passing Zone” Sign 15
 - 75-3.09 Parking Signs 15
 - 75-3.10 “No Turn On Red” Sign 15
- 75-4.0 WARNING SIGNS 16
 - 75-4.01 Placement of Advance Warning Sign..... 16
 - 75-4.02 Advance Turn or Advance Curve Symbol Sign 17
 - 75-4.03 Chevron Symbol Sign..... 19
 - 75-4.04 Signal Ahead Symbol Sign..... 19
 - 75-4.05 Advisory Exit Speed Sign..... 20
 - 75-4.06 Advance Street or Road Name Sign 20
- 75-5.0 GUIDE SIGNS 20
 - 75-5.01 Distance Sign..... 20
 - 75-5.02 Logo Signing 21
 - 75-5.03 Supplemental Guide Signs..... 21
 - 75-5.04 Guide Signs for Interchange Crossroads 21
 - 75-5.05 Street Name Sign 22

List of Figures

<u>Figure</u>	<u>Title</u>
<u>75-2C</u>	<u>Sign Gore Treatment</u>
<u>75-2D</u>	<u>Sign Types</u>
<u>75-4A</u>	<u>Suggested Minimum Distances for Placement of Advance Warning Signs</u>
<u>75-4B</u>	<u>Conditions for Placement of Advance Warning Signs</u>
<u>75-4C</u>	<u>Ball-Bank Indicator Readings</u>
<u>75-5A</u>	<u>Regional Control Cities for Indiana Interstates</u>
<u>75-5B</u>	<u>National Control Cities for Indiana Interstates</u>
<u>75-5C</u>	<u>Guidelines for Signing Traffic Generators on Freeways</u>
<u>75-5D</u>	<u>Typical Crossroad Signing at Freeway Interchanges</u>
<u>75-5E</u>	<u>Diamond Interchange Signing (Freeway Under Divided Highway)</u>
<u>75-5F</u>	<u>Diamond Interchange Signing (Freeway Over Divided Highway)</u>
<u>75-5G</u>	<u>Diamond Interchange Signing (Freeway Under Undivided Highway)</u>
<u>75-5H</u>	<u>Diamond Interchange Signing (Freeway Over Undivided Highway)</u>
<u>75-5 I</u>	<u>Full Cloverleaf Interchange Signing (Freeway Under Divided Highway)</u>
<u>75-5J</u>	<u>Full Cloverleaf Interchange Signing (Freeway Over Divided Highway)</u>
<u>75-5K</u>	<u>Full Cloverleaf Interchange Signing (Freeway Under Undivided Highway)</u>
<u>75-5L</u>	<u>Full Cloverleaf Interchange Signing (Freeway Over Undivided Highway)</u>
<u>75-5M</u>	<u>Partial Cloverleaf Interchange Signing (Freeway Under Divided Highway)</u>
<u>75-5N</u>	<u>Partial Cloverleaf Interchange Signing (Freeway Over Divided Highway)</u>
<u>75-5 O</u>	<u>Partial Cloverleaf Interchange Signing (Freeway Under Undivided Highway)</u>
<u>75-5P</u>	<u>Partial Cloverleaf Interchange Signing (Freeway Over Undivided Highway)</u>
<u>75-5Q</u>	<u>Trumpet Interchange Signing System (One Road Terminates)</u>

CHAPTER SEVENTY-FIVE

HIGHWAY SIGNS

The majority of the information required for the selection, design, and placement of highway signs is shown in the *Manual on Uniform Traffic Control Devices (MUTCD)* and the *INDOT Standard Drawings*. The intent of this chapter is not to reiterate the information presented in these sources, but rather to supplement these references and, where deemed necessary, to provide the user with additional guidance.

75-1.0 MUTCD CONTEXT

Throughout the *MUTCD*, the words *shall*, *should*, and *may* are used to describe the appropriate application for various traffic-control devices. The *MUTCD* defines these terms as follows:

1. **Shall**. A mandatory condition. Where certain requirements in the design or application of the device are described with this stipulation, it is mandatory where an installation is made that such requirements be met.
2. **Should**. An advisory condition. Where this stipulation is used, it is considered to be advisable usage, recommended but not mandatory.
3. **May**. A permissive condition. No requirement for design or application is intended.

The *MUTCD* shall prevail on each public highway or street in which Federal funds will be or were used.

The *MUTCD* shall prevail on the National Highway System regardless of the funding source.

75-2.0 GENERAL CRITERIA

A sign should only be used where it is warranted by the *MUTCD* criteria, accident history, or field studies. A sign should provide information on special regulations, for hazards which are not self-evident, or for highway routes, directions, destinations, or points of interest. Each traffic-control device should be in accordance with the basic requirements as follows.

1. It should be capable of fulfilling an important need.

2. It should command attention.
3. It should convey a clear, simple meaning.
4. It should command respect of road users.
5. It should be located to give adequate time for response.
6. It must be sanctioned by law if it controls or regulates traffic.

75-2.01 References

The following is the recommended list of publications for selecting, designing, manufacturing, or installing highway signs.

1. *Manual on Uniform Traffic Control Devices*, FHWA;
2. *Traffic Control Devices Handbook*, FHWA;
3. *Standard Highway Signs*, FHWA;
4. *INDOT Standard Highway Signs*;
5. *Standard Alphabets for Highway Signs and Pavement Markings*, FHWA;
6. *Standard Specifications for Structural Supports for Highway Signs, Luminaires and Traffic Signals*, AASHTO;
7. *INDOT Standard Specifications*;
8. *Traffic Engineering Handbook*, Institute of Transportation Engineers;
9. Chapter Forty-nine of this *Manual*; and
10. *Manual of Steel Construction*, American Institute of Steel Construction.

The INDOT publications may be obtained by contacting the Traffic Control Systems Division. For other publications, the indicated source should be contacted.

75-2.02 Reflectorization

All signs should be reflectorized. The INDOT *Standard Specifications and Standard Drawings* provide the reflectorization criteria for signs. Illumination will be required only as described in

Section 75-2.03. The reflective-sheeting type should not be shown on the plans, and is not included in the pay-item names. For a local facility, reflectorization of signs will be based on the city or county's preference. For additional information on reflective materials, the publications that can be reviewed are as follows:

1. *Retroreflectivity of Roadway Signs for Adequate Visibility: A Guide*, FHWA/DF-88/001, November 1987.
2. NCHRP Report 346, *Implementation Strategies for Sign Retroreflectivity Standards*, TRB, April 1992.
3. ASTM Designation: D4956 *Standard Specification for Retroreflectivity Sheeting for Traffic Control*, latest version.

75-2.03 Illumination

Most signs are designed to be illuminated by vehicular headlights and the sign message reflected back to the driver. Therefore, external sign lighting and related appurtenances such as a sign walkway will not be required for an overhead-sign or box-truss structure, and should not be shown on the plans.

However, conduit should be specified to be installed in the foundations. A structure handhole should be specified to be placed toward the base of the sign support. A grounding system should be specified.

Sign-structure mounting height should be specified as described in Section 75-2.03, if a lighting-support assembly or walkway must be retrofitted.

Lighting may be provided for the sign preceding a truck weigh station which indicates that the station is open or closed. This is accomplished with an internally-lighted sign.

75-2.04 Sign Placement

The *MUTCD* and the *INDOT Standard Drawings* provide criteria for the placement of a sign next to or over the roadway. These sources also provide criteria for the maximum and minimum allowable sign heights.

A warning sign is to be placed in advance of the condition to which it calls attention. A regulatory sign is placed where its mandate or prohibition applies or begins. A guide sign is placed at a variable location to inform drivers of their route of travel, destination, or point of interest.

The uniform position of each sign, although desirable, is not always practical to achieve because the alignment and design of the road often dictates the most advantageous position for the sign. For determining the sign location, the designer should review the guidelines as follows.

1. A sign should be placed on the driver's right side. A sign may sometimes be placed on a channelizing island or overhead or, where there are short sharp curves to the right, it may be placed on the driver's left side directly in front of the driver.
2. A dual-mounted sign may be considered for additional emphasis where it is anticipated that a single sign may not provide adequate warning, such as at an intersection just beyond a sharp horizontal curve or at a location where a driver may be required to make an unexpected maneuver.
3. Sign placement and the roadway geometric design should be coordinated as early as practical during the project planning and design stages. If a roadway design does not permit adequate placement of the required signs, the geometric design may need to be revised accordingly. An improper geometric design cannot always be corrected by signing.
4. Where lane control is desired, a sign should be placed directly over its affected lane.
5. Each sign should be located to optimize nighttime visibility.
6. Adherence to the criteria provided in the *MUTCD* and *INDOT Standard Drawings* is not always practical. Actual sign placement may be adjusted to meet field conditions. The placement problem areas that should be avoided are as follows:
 - a. at a short dip in the roadway;
 - b. beyond the crest of a vertical curve;
 - c. where a sign may be obscured by parked cars;
 - d. where a sign would create an obstruction for pedestrians or bicyclists;
 - e. where a sign would interfere with a driver's visibility to hazardous locations or objects;

- f. where sign visibility would be impaired due to existing overhead illumination;
 - g. where a sign is vulnerable to roadside splatter or to being covered with snow by plowing operations; or
 - h. too close to trees or other foliage that could cover the sign face now or in the future.
7. A sign's location can sometimes be shifted longitudinally without compromising its intended purpose. This may improve its visibility, avoid blocking other signs, enhance safety, or enhance traffic operations (e.g., by providing more distance between signs in a series).
 8. Each sign should be erected individually on separate posts or mountings. However, it may be appropriate to group signs (e.g., route-marker assemblies) with consideration for wind loading and breakaway characteristics.
 9. The INDOT *Standard Drawings* provide criteria for the lateral clearance of roadway signing. The designer should also review Section 75-2.05.
 10. Each wide-flange post installation should include a perforated fuse plate as well as a perforated hinge plate. A note on the plan sheet and wide-flange sign summary sheet should also be included, so that the contractor will install the structure accordingly.

75-2.05 Roadside Safety

Chapter Forty-nine describes the Department's criteria for clear zones, roadside barriers, impact attenuators, and other roadside safety issues. These are also applicable to roadside signs. The designer should also consider the following.

1. Ground-Mounted-Sign Support. The support for each ground-mounted sign should be made breakaway or yielding, including that outside the clear zone. Posts should be of the square cross section type shown on the INDOT *Standard Drawings*. However, for a local agency project, channel posts may be used if desired by the local agency. A new sign support behind guardrail should have adequate clearance to the back of the guardrail post to provide for the guardrail's dynamic deflection (see Section 49-4.0).
2. Overhead-Sign Support. The support for each overhead sign should be non-breakaway. Each overhead-sign structure inside the clear zone must be protected with guardrail or, where applicable, with an impact attenuator. In a median, an overhead-sign support should be protected as follows.

- a. If the distance between the sign support and the edge of the travel lane or auxiliary lane is 25 ft or less, an impact attenuator should be used.
- b. If the distance between the sign support and the edge of the travel lane or auxiliary lane is greater than 25 ft, a gravel barrel array should be used.

See Section 49-6.0 for additional information on the design and layout of impact attenuators.

3. **Ground-Mounted Panel Sign.** A sign of over 48 ft² in area on slipbase breakaway supports should not be placed where the opportunity exists for it to be struck at a point that is more than 9 in. above the normal point of vehicular bumper impact. Normal bumper height is 1'-6". To avoid being struck at an improper height, a sign should be placed as follows.
 - a. **Fill Slopes Flatter than 4:1.** A sign should be located a minimum of 30 ft from the edge of the travel lane to the nearest edge of the sign.
 - b. **Fill Slopes 4:1 or Steeper.** The nearest sign edge should be located 6 ft from the edge of shoulder or 12 ft from the edge of the travel lane, whichever is greater.
4. **Roadside Appurtenance.** A large breakaway sign support should not be located in or near the flow line of a ditch. If such a support is placed on a backslope, it should be offset at least 3 ft from the toe of the backslope of the ditch.
5. **Exit Gore Sign.** An exit gore sign should be placed in each gore area of a freeway as shown on Figure 75-2C, Sign Gore Treatment.

75-2.06 Overhead Panel Sign

The following provides guidelines to consider in whether to place an overhead or ground-mounted panel sign.

1. **Lane Control.** An overhead sign should be considered where the message is applicable to a specific lane. If the sign is placed over the lane, lane use can be made significantly more effective, especially where additional guidance is required for a driver who is unfamiliar with the area.
2. **Visibility.** An overhead sign should be considered where traffic or roadway conditions are such that an overhead mounting is necessary for adequate visibility (e.g., vertical or horizontal curve, closely spaced interchanges, three or more through lanes in one direction).

3. Divergent Roadways. An overhead sign should be considered at, or just in advance of, a divergence from a heavily traveled roadway (e.g., at a ramp exit where the roadway becomes wider and a sign on the right side is usually not in the line of sight for the driver).
4. Exit. An overhead panel sign should be considered where left-hand or multi-lane exit ramps are in place.
5. Interchange. An overhead panel sign should be considered at a complex interchange where there may be driver confusion, where there are closely-spaced interchanges, Interstate-to-Interstate interchanges, or where there are lane drops on the exit ramp or mainline within the interchange.
6. Trucks. An overhead sign should be used where there are significant numbers of large trucks which may block a passenger-car driver's visibility to a ground-mounted sign.
7. Limited Right of Way. An overhead panel sign should be considered where there is limited space for a sign on the roadside (e.g., where right of way is narrow).
8. Roadside Development. An overhead sign should be considered where roadside development seriously detracts from the effectiveness of a roadside sign (e.g., a brightly-lighted area).
9. Uniformity. An overhead sign may be used to be consistent with other signs on a given section of highway.

Each new overhead sign installation will require a minimum vertical clearance of 17'-6" above the roadway and shoulders but not greater than 18'-0". This includes an additional 6 in. clearance for a future overlay. An existing overhead sign may have a vertical clearance of 17'-0".

Where sign lighting is used, an overhead sign should not be placed on a bridge overpass. A non-lighted sign may be placed on an overcrossing structure provided that the vertical clearance of the sign exceeds the vertical clearance of the overcrossing structure by at least 6 in.

75-2.07 Sign Priority

Providing motorists with too much information may cause improper driving and impair safety. Therefore, some sign information should be removed, replaced, or relocated. Where sign-information overload may be a problem, the following lists the recommended priority for sign types.

1. regulatory (e.g., speed limit, stop, turn prohibition);

2. warning (e.g., curve, crossroad, narrow bridge);
3. guidance (e.g., destination, routing);
4. emergency services (e.g., hospital, telephone);
5. motorist services (e.g., fuel, food, camping);
6. public-transportation (e.g., park and ride, bus stop);
7. traffic-generators (e.g., museum, stadium, historic building); and
8. general information (e.g., county line, city limit).

Within the various sign groups, the sign bearing the most important message should supersede the others.

75-2.08 Computer Software

There are many computer software programs available that may be used in the design of highway signing including sign layouts, legends, quantities, structural supports, etc. The designer should be aware that not all software packages are applicable to Indiana. Therefore, the user should first contact the Traffic Control Systems Division to determine which programs and versions are acceptable for use for a project. The following is a brief summary of the programs currently acceptable to the Department.

1. SignCAD 2000. This program helps the designer determine the appropriate panel size for each guide sign along a freeway. The program was developed by Berg and Effrem, Inc.
2. GuidSIGN. This program provides the designer with standardized guide-sign layouts, text fonts, letter spacing, and sign sizes. The program was developed by Transoft Solutions.

Addresses or contacts for the software companies listed above may be obtained from the Traffic Control Systems Production Management Division.

75-2.09 Symbology

Where the *MUTCD* permits the use of either words or symbols on the sign, the preferred practice is to use only the symbol message.

75-2.10 Structural Design

The INDOT *Sign Design Guide* provides the Department's criteria for foundation design, sign structure design, I-beam post selection, etc. Copies of this publication can be obtained from the Traffic Control Systems Division.

75-2.11 Applications

All placement and usage of signs should follow the criteria described in the *MUTCD* and INDOT *Standard Drawings*. The use of an experimental traffic control device is acceptable provided that its approval is in accordance with the criteria shown in the *MUTCD*. Figure 75-2D, Sign Types, provides guidelines for general usage of each sign type. The following sections on regulatory, warning, and guide signs provide additional guidance or supplementary information for specific signs. For all signs, including those in the following sections, the references in Section 75-2.01 should be reviewed to determine the appropriate sign application.

75-3.0 REGULATORY SIGNS

75-3.01 Official Action

An Official Action will be required if there is a proposed change in the regulatory nature of a sign or situation affecting a facility. For example, an Official Action is required if changes are made to the intersection control, parking restrictions, no-passing zones, traffic signals, or certain work-site speed zones (e.g., installing a stop sign at an existing uncontrolled intersection). For a Department-maintained facility, the designer must obtain an approval for the proposed change from the appropriate district traffic engineer prior to implementation of the change. For a local facility, approval must be obtained from the appropriate jurisdiction prior to implementation.

75-3.02 “Stop” or “Yield” Sign

75-3.02(01) General

A “Stop” sign should be installed at each at-grade, non-signalized local road or street which intersects a Department-maintained highway. A “Yield” sign may be used if the intersection is operating in a merge condition (e.g., channelized intersection with a turning roadway) or at an entrance ramp to an access-controlled facility.

For a local facility, the warrants provided in the *MUTCD* should be followed. For additional information, the following publications may be reviewed to determine the need for a “Stop” or “Yield” sign.

1. *Stop, Yield, and No Control at Intersections*, Report No. FHWA/RD-81/084, FHWA, June 1981; or
2. NCHRP 320, *Guidelines for Converting Stop to Yield Control at Intersections*, TRB, October 1989.

75-3.02(02) Multiway Stop Control

The *MUTCD* describes the warrants for where a multiway “Stop” sign installation may be considered. However, it should not be used unless the traffic volume for each approach leg of the intersection is approximately equal. A traffic signal is the preferred traffic-control device for an intersection with heavy traffic volume.

A multiway stop control is frequently used in a residential area. The following lists guidelines for the installation of a multiway stop control in a residential area.

1. Collector Streets. At the intersection of two collector streets that are primary to the area.
2. Four-Way Intersection. Where there is a 60-40 percent (or closer) volume split for the intersection.
3. Three-Way Intersection. Where there is a 75-25 percent (or closer) volume split for the intersection.
4. Accidents. Where there are three or more accidents in one year’s time.

75-3.02(03) Stop Sign at Railroad Crossing

A “Stop” sign may be placed at each roadway approach to a railroad crossing where two or more trains cross per day and is without automatic traffic-control devices. For a crossing with passive protection, a “Stop” sign may be placed after a need has been established by a traffic-engineering study. The study should consider such factors as volume and character of highway and train traffic, adequacy of stopping sight distance, crossing accident history, and need for active control devices. Where a “Stop” sign is installed, a “Stop Ahead” advance warning sign should also be installed.

75-3.03 Speed Limit Sign

The district traffic engineer is responsible for determining the speed limits on each Department-maintained facility. Each request for a speed-limit determination must be transmitted to the appropriate district office. For a local facility, each local jurisdiction is responsible for determining the appropriate speed limits within its boundaries. This typically occurs after a speed study has been conducted. When determining a speed limit, the considerations are as follows:

1. the 85th-percentile speed;
2. the design speed used during project design;
3. the road-surface characteristics, shoulder condition, grade, alignment, and sight distance;
4. functional classification and type of area;
5. type and density of roadside development;
6. the accident experience during the previous 12 months;
7. parking practices and pedestrian activity; and
8. the maximum or minimum speed permitted by State law.

The *MUTCD* indicates the elements that should be reviewed in an engineering study. The *ITE Manual of Traffic Engineering Studies* provides guidance on how to conduct a speed study. Each public road's speed is controlled by means of a regulatory speed limit, either through a "Speed Limit" sign or a speed limit established by State law. Section 40-3.02(03) lists the maximum and minimum legal speed limits for a rural or urban area and for a State or local facility.

75-3.04 "No U-Turn" Sign

On a freeway, the "No U Turn" sign should be placed at each median crossover. This sign should be placed at the far side of the median crossover for oncoming traffic.

75-3.05 Lane-Use Control Signs at Intersection

An overhead lane-use control sign should be placed at a major urban intersection where left- and right-turn lanes are provided or where there is the possibility of confusion at the intersection.

75-3.06 "Right Turn Only" Sign

Where an exclusive right-turn-only lane is provided, the use of an overhead sign should be considered where background clutter may be a problem. If background clutter is not a problem, a ground-mounted sign may be as visible and may be more cost effective.

75-3.07 Two-Way Left Turn Only (TWLTO) Signs

An overhead lane-control sign should be provided at the beginning and end of a two-way left-turn-only lane. In an urban area, one should also be placed at approximately every 1000 ft along the lane. In a suburban or built-up rural area, the intermediate TWLTO sign spacing may be increased to 1200 ft. For the beginning and end, the supplementary “Begin” and “End” plates should also be included.

A TWLTO sign should also be used on the back side of a “Left Turn Only” sign where a two-way left-turn-only lane is transitioned into a one-way left-turn lane. The supplementary “Begin” and “End” plates are not included for this situation. Section 76-2.05(02) illustrates the pavement markings used for this transition.

The preferred practice is to install the signs as ground-mounted. Signs should be placed on an overhead structure only if the district traffic engineer deems necessary.

75-3.08 “No Passing Zone” Sign

The beginning of a no-passing zone is marked with a “No Passing Zone” sign on the driver’s left side of the roadway. The end of the zone is indicated with a sign post installed on the driver’s right side of the roadway with three white delineators attached. A “No Passing Zone” sign is not required for a zone marked due to presence of a railroad crossing, nor at a zone marked due to presence of an intersection or in an urbanized area.

75-3.09 Parking Signs

The generic “No Parking” sign should be used where practical on a Department-maintained facility. Where necessary, signs with other messages regarding parking restrictions or permissions may be used as shown in the *MUTCD*.

75-3.10 “No Turn On Red” Sign

A right turn at a red light after a stop is permitted at each intersection leg unless the leg is signed to prohibit it. Where two one-way streets intersect, a left turn at a red light after a stop is permitted at each applicable intersection leg unless the leg is signed to prohibit it. After conducting an engineering study as defined in the *MUTCD*, the designer will submit a recommendation on the need for eliminating turn-on-red movements to the district traffic engineer or to the appropriate local jurisdiction. The district traffic engineer or local jurisdiction will have final approval for each turn-

on-red restriction. Once the decision has been made to eliminate the turning movement, the proper “No Turn On Red” sign should be placed as specified in the *MUTCD*.

75-4.0 WARNING SIGNS

A warning sign is used where it is deemed necessary to warn a driver of an existing or potentially hazardous condition on or adjacent to a highway or street. Each warning sign must be located in advance of the condition to which it applies. The use of warning signs should be kept to a minimum. Overuse of warning signs at an obvious hazardous location tends to cause non-compliance for all signs. The following provides additional guidance for the placement of warning signs.

75-4.01 Placement of Advance Warning Sign

Figure 75-4A, Suggested Minimum Distances for Placement of Advance Warning Signs, provides the suggested minimum distances for preliminary placement of advance warning signs. The final location for each warning sign will be determined during the field check in conjunction with INDOT or local agency personnel. The distances in Figure 75-4A are based on the conditions which are defined by the *MUTCD* as follows.

1. Condition A. A high driver-judgment condition which requires the driver to use extra time in making and executing a decision because of a complex driving situation.
2. Condition B. A condition in which the driver will likely be required to stop.
3. Condition C. A condition in which the driver will likely be required to decelerate to a specific speed.

If these distances cannot be achieved, other measures should be considered to attract the motorist’s attention to the sign. These additional measures will be determined as required for each site.

For those warning signs typically used by the Department, Figure 75-4B indicates which of the three Conditions will most likely apply. The following examples illustrate how to use Figures 75-4A and 75-4B, Conditions for Placement of Advance Warning Sign.

* * * * *

Example 75-4.1

Given: Stop-controlled intersection

Posted speed limit on stop-controlled leg is 50 mph

Problem: Where to place a “Stop Ahead” sign

Solution: From Figure 75-4B it is determined that the “Stop Ahead” sign is a Condition B category (i.e., the driver must stop). From Figure 75-4A, the set-back distance from the “Stop” sign should be 375 ft.

If the sign cannot be adequately placed at a set-back distance of approximately 375 ft, then other measures may be required to provide additional emphasis to the warning sign.

Example 75-4.2

Given: A 45-mph horizontal curve
Posted speed limit 55 mph

Problem: Where to place an Advance Curve symbol sign

Solution: From Figure 75-4B it is determined that the Advance Curve symbol sign is a Condition C category (i.e., the driver must slow down from 55 mph to 45mph). From Figure 75-4A, the minimum set-back distance from the horizontal curve’s PC is shown to be 180 ft.

An Advisory Speed “45 MPH” plate indicating that the maximum recommended speed for negotiation of the curve is 45 mph should also be used.

* * * * *

75-4.02 Advance Turn or Advance Curve Symbol Sign

The *MUTCD* describes several horizontal-alignment signs, but it does not fully identify where to use these signs. The decision on using an advance turn or curve symbol sign is dependent upon many factors including posted speed, alignment, accident history, etc. It would be impractical and uneconomical to place an advance warning sign at every horizontal curve. Before using an advance turn or curve sign, the designer should consider the following:

1. **Speed Determination.** In determining whether or not to place an alignment warning sign and advisory speed plate, the designer first must determine the appropriate speed for negotiating

the curve. If the curve radius and superelevation rate are known (e.g., from construction plans), then the appropriate negotiation speed can be calculated (see Section 43-2.0). If the radius of the curve is unknown, then a field study is warranted. This type of study is done using a ball-bank indicator.

The ball-bank indicator test involves driving a test vehicle around a curve at various speeds and reading a curved level to determine an appropriate negotiation speed for the curve. Figure 75-4C, Ball-Bank Indicator Readings, lists the various maximum recommended negotiation speeds for a curve based on several ball-bank readings. Test runs should be conducted in both directions.

2. Highway Alignment. The designer should review the overall highway alignment to determine if advance curve signs are warranted. An unexpected curve after a long tangent section is a likely candidate for placement of an advance curve sign. Conversely, curves on a winding highway may not warrant the use of an advance curve sign because the driver will be expecting the curve. An advance curve sign should always be provided where the vertical alignment obstructs the driver's vision of the horizontal curvature.
3. Posted Speed. Relative to the posted speed, the designer should consider the following:
 - a. A highway with a posted or statutory speed limit of lower than 30 mph will not warrant an advance warning sign.
 - b. An advance curve sign should be considered if the maximum recommended negotiation speed of the curve is found to be more than 12 mph below the posted speed limit.
4. Accident History. The accident history should be reviewed to determine if there is a disproportionate number of run-off-the-road accidents that can be attributed to the horizontal curve. A high-accident location will most likely warrant an advance curve sign, an Advisory Speed plate, or Chevron symbol signs.
5. Driver Familiarity. A highway serving local needs (e.g., collector or local road) will rarely warrant advance curve signs because the typical driver will be aware of the restrictive alignment. However, on an arterial or a recreational road, the typical driver may be less familiar with the highway, so it may require additional warnings.
6. Area Classification. An urban area will not warrant the use of advance curve signs because speeds tend to be lower and there is greater driver familiarity and awareness.

7. Public Reaction. Local residents have some indication of how drivers are reacting to a horizontal curve. If there are no complaints relative to near misses or accidents, the curve will probably not warrant the need for signing. Frequent complaints usually warrant further investigation.
8. Advance Turn Versus Advance Curve Symbol Sign. If it is determined that an advance alignment warning sign is warranted, the *MUTCD* recommends that an Advance Turn symbol sign be used if the curve's maximum recommended negotiation speed is 30 mph or lower. An Advance Curve symbol sign should be used if the curve's maximum recommended negotiation speed is higher than 30 mph.
9. Advisory Speed Plate. If an Advance Turn symbol sign is to be placed, an Advisory Speed plate should also be placed showing the maximum recommended speed. For an Advance Curve symbol sign, an Advisory Speed plate should be placed if the recommended negotiation speed of the curve is more than 12 mph lower than the posted speed limit. An Advisory Speed plate is not required where the curve-negotiation speed is equal to or higher than the posted or statutory speed limit.
10. Combination Curve. A combination curve consists of two or more successive curves. They may be connected with or without a short tangent section, and they may be in the same or in opposite directions. If either of the curves requires an Advance Curve or Advance Turn symbol sign, a Reverse Curve symbol sign should be used instead. For three or more successive curves, the Winding Road symbol sign should be used. If an Advisory Speed plate is necessary, the lowest recommended negotiation speed for all of the curves should be shown on the plate.

75-4.03 Chevron Symbol Sign

A Chevron symbol sign should be used where there is a history of run-off-the-road accidents in conjunction with a horizontal curve. The Department's practice is to install at least three Chevron symbol signs. The *MUTCD* provides the criteria for placement of such signs.

75-4.04 Signal Ahead Symbol Sign

The need for the Signal Ahead symbol sign will be determined for each signalized intersection based on the accident history and sight-distance restrictions. Typical locations for a Signal Ahead symbol sign include an isolated signalized intersection or in advance of the first intersection in a series of signalized intersections. They are not used in an urban area with multiple signalized intersections.

75-4.05 Advisory Exit Speed Sign

An Advisory Exit Speed sign should be placed at each exit-ramp gore where the ramp design speed is lower than the mainline design speed. The “Exit ____ MPH” sign may be used on the ramp. If the ramp connects two freeways or expressways, the “Ramp ____ MPH” sign should be used.

75-4.06 Advance Street or Road Name Sign

An Advance Street or Road Name sign may be provided before each major street crossing. On a Department-maintained facility, a sign is usually not provided for a minor street crossing. This supplementary sign is used in conjunction with the Cross Road, Side Road, or Signal Ahead symbol sign.

75-5.0 GUIDE SIGNS

The *MUTCD* provides the criteria for the placement and design of guide signs. In addition, the following provides supplemental information relative to guide signs.

75-5.01 Distance Sign

A Distance sign can display two or three destination points and the distances to these destinations. Destination points should be arranged on the Distance sign as follows:

1. **Top Line.** The top line should include the name of the next meaningful community, number of the next intersecting route, or name of the next intersecting highway, and distance in miles to it, on which the traveler’s route passes.
2. **Middle Line.** The middle line, if used, should include the name of a community, number of an intersecting route, or name of an intersecting highway, and distance in miles to it, that is beyond the destination listed in the top line and is of general interest to the traveler. Figure 75-5A provides a list of the regional control cities for use on distance signs along the Interstate system. Regional control cities are the intermediate cities between the major control cities that are located within the State’s boundaries.
3. **Bottom Line.** The bottom line should include the name of the next national control city and the distance in miles to it. Figure 75-5B provides a list of the major control cities for use on

distance signs along the Interstate system. National control cities are those cities which have national significance for the through traveler.

75-5.02 Logo Signing

A Logo sign is a specific-informational panel that has a separately-attached sign consisting of a single or multicolored symbolic design unique to a product, business, or service facility. It is used to identify traveler services that are available on a crossroad at or near an interchange or an intersection. Information on INDOT's logo signing policy can be found in the State statutes or by contacting the Highway Operations Division. These signs are placed and maintained through a contract with INDOT. However, Logo signs are a part of the INDOT signing system. They may be relocated or temporarily removed as deemed necessary by the contractor. The *MUTCD* should be consulted in the design, layout, and placement of each Logo sign.

75-5.03 Supplemental Guide Signs

Figure 75-5C describes the Department's general guidelines for determining the eligibility of traffic generators (cities, attractions, other major traffic generators) to place a permanent tourist-oriented directional sign or other supplemental information guide sign along a Department-maintained highway. If the designer is requested to install new such signage, he or she should contact the Highway Operations Division or the district traffic engineer for more information on the Department's supplemental-guide-signage policy.

75-5.04 Guide Signs for Interchange Crossroads

The design and layout criteria for Advance Exits and Directional signs on a freeway are clearly defined and shown in the *MUTCD*. Figures 75-5D through 75-5Q illustrate INDOT's preferred practice for the placement of Directional signs along the crossroad approaching an interchange. Figure 75-5D lists the guidelines for which sign layout plans shown in Figures 75-5E through 75-5Q should be used for the various interchanges and crossroad types. The figures and the titles are listed below.

75-5D	Typical Crossroad Signing at Freeway Interchange
75-5E	Diamond Interchange Signing (Freeway Under Divided Highway)
75-5F	Diamond Interchange Signing (Freeway Over Divided Highway)
75-5G	Diamond Interchange Signing (Freeway Under Undivided Highway)
75-5H	Diamond Interchange Signing (Freeway Over Undivided Highway)
75-5 I	Full Cloverleaf Interchange Signing (Freeway Under Divided Highway)

75-5J	Full Cloverleaf Interchange Signing (Freeway Over Divided Highway)
75-5K	Full Cloverleaf Interchange Signing (Freeway Under Undivided Highway)
75-5L	Full Cloverleaf Interchange Signing (Freeway Over Undivided Highway)
75-5M	Partial Cloverleaf Interchange Signing (Freeway Under Divided Highway)
75-5N	Partial Cloverleaf Interchange Signing (Freeway Over Divided Highway)
75-5 O	Partial Cloverleaf Interchange Signing (Freeway Under Undivided Highway)
75-5P	Partial Cloverleaf Interchange Signing (Freeway Over Undivided Highway)
75-5Q	Trumpet Interchange Signing System (One Road Terminates)

See the INDOT *Standard Drawings* for ground-mounted panel-sign wide-flange posts quantities, length, and size determination.

75-5.05 Street Name Sign

A Street Name sign is very helpful to the motorist and should be legible for a sufficient distance in advance of the cross street to permit the motorist to perceive and react in time to make the desired maneuver in a safe manner. In order to provide adequate sign visibility, sign letter heights should be as follows:

1. Ground-Mounted Sign.
 - a. Posted speed limit \geq 30 mph.
 - (1) Upper-case letters: Series C or D, 6 in. height
 - (2) Lower-case letters: Series C or D, 4½ in. height
 - b. Posted speed limit \leq 25 mph: Upper-case letters only, Series C or D, 4 in. height.
2. Overhead Sign.
 - a. Upper-case letters: Series EM, 8 in. height.
 - b. Lower-case letters: Series EM, 6 in. height.

* 6 ft PLUS SHOULDER WIDTH OR 12 ft, WHICHEVER IS GREATER

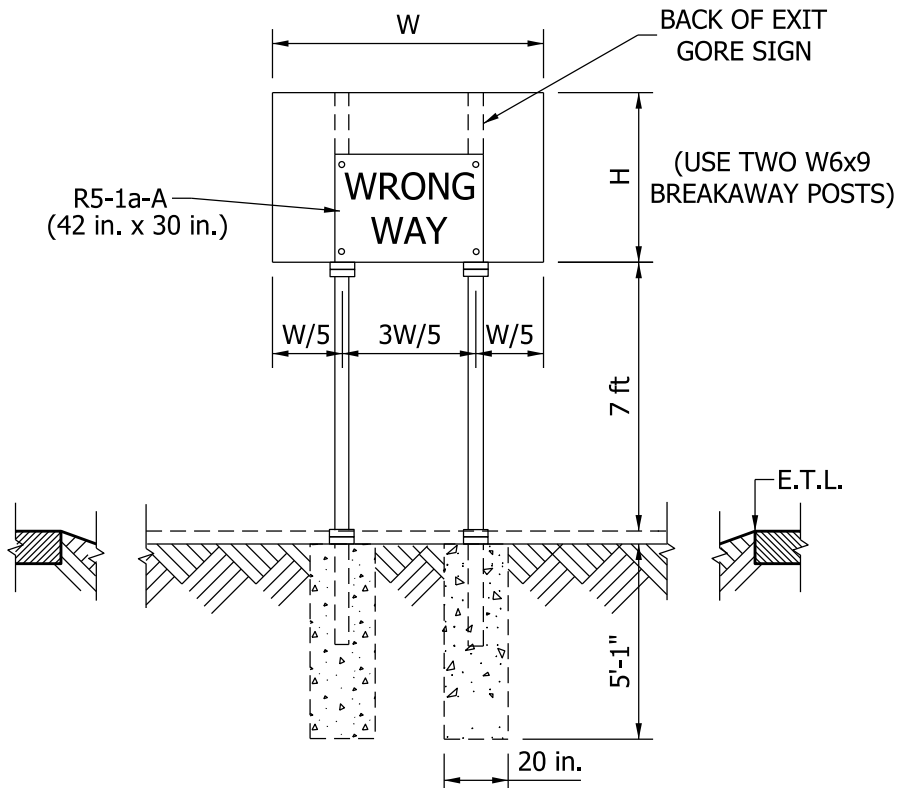
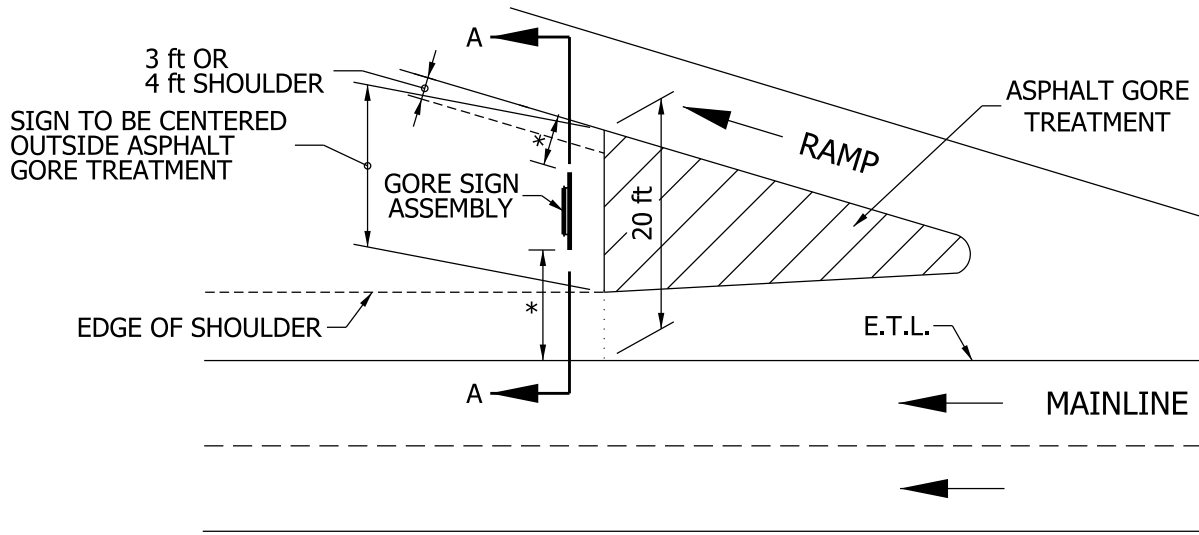

SECTION A-A

SIGN GORE TREATMENT

Figure 75-2C

Sign Type	Intended Use	Typical Uses
Regulatory	To inform motorist of traffic law or regulation which applies at definite location or specific time.	<ul style="list-style-type: none"> 4 Intersection control 4 Designating legal right-of-way 4 Speed limit 4 Turning movement control 4 Pedestrian control 4 Exclusion or prohibition 4 Parking control and limits 4 Regulations for maintenance or construction area
Warning	To warn motorist of unusual or potentially hazardous condition(s) on or adjacent to a street or highway.	<ul style="list-style-type: none"> 4 Horizontal alignment 4 School area 4 Crossing or entrance to street, highway, or freeway 4 Intersection 4 Road construction or maintenance
Guide	To provide simple and specific information to aid motorist in reaching his or her destination.	<ul style="list-style-type: none"> 4 Route markings 4 Destination 4 Information 4 General services 4 Parks and recreational signing

SIGN TYPES

Figure 75-2D

Posted or 85th percentile speed (mph)	Condition A: High Judgment needed ^{1,2} (ft)	General Warning Signs ^{1,3}								
		Condition B: Stop Condition (ft)	Condition C: Deceleration to indicated advisory speed or desired speed (mph) at condition (ft)							
			15	20	25	30	35	40	45	50
20	150	Note 4	Note 4	--	--	--	--	--	--	--
25	250	75	30	Note 4	--	--	--	--	--	--
30	325	150	100	75	Note 4	--	--	--	--	--
35	425	200	175	150	100	50	--	--	--	--
40	500	300	250	225	200	150	75	--	--	--
45	550	350	300	300	250	200	125	75	--	--
50	600	375	350	350	275	225	150	100	75	--
55	700	450	425	400	350	300	250	175	150	100
60	800	550	500	500	450	400	350	275	250	200
65	875	625	600	575	550	500	450	375	350	95

Notes:

1. Distance shown is for a level roadway. Distance is based on placement of a 36 in. x 36 in. sign. If a 48 in. x 48 in. sign is placed, the legibility distance may be increased to 200 ft. This would permit reducing the above distance by 65 ft.
2. Distance is based on 10-second perception/reaction time and 125 ft sign legibility distance. In an urban area, a supplementary plate underneath the warning sign should be used specifying the distance to the condition if there is an intersection between the sign and the condition which might confuse the motorist.
3. Distance provides for 125 ft sign legibility distance, 3 s in gear and comfortable braking distance as indicated in the AASHTO A Policy on Geometric Design of Highways and Streets.
4. No suggested minimum distance provided. At this speed, sign location depends on physical conditions at site.
5. The suggested minimum distance is for preliminary placement of an advance warning sign. The final location will be determined during the field check in conjunction with INDOT or local agency personnel.

**SUGGESTED MINIMUM DISTANCES FOR
PLACEMENT OF ADVANCE WARNING SIGNS**

Figure 75-4A

CONDITION A	CONDITION B	CONDITION C
W4-1 (L)	W2-1	W1-1 (L)
W4-1 (R)	W2-2 (L)	W1-1 (R)
W4-2 (L)	W2-2 (R)	W1-2 (L)
W4-2 (R)	W2-4	W1-2 (R)
W4-3 (L)	W2-5	W1-3 (L)
W4-3 (R)	W3-1	W1-3 (R)
W5-3	W3-3a	W1-4 (L)
W9-1 (L)	W8-6	W1-4 (R)
W9-1 (R)	W8-6A	W1-5 (L)
W9-2 (L)	W8-6S	W1-5 (R)
W9-2 (R)	W10-1	W5-1
W9-13 (L)	W11-1	W5-2
W9-13 (R)	W11A-2	W6-3
W12-2	W11-3	W6-3A
W6-1	W11-4	W7-1
W6-1a	W11-5	W7-1a
W6-2	W11-6	W8-1
W6-2a	W11-8	W8-2
	W11-9	W8-5
		W13-1
		W13-2
		W13-3

Note: This list only applies to those warning signs typically used by the Department. See Section 75-4.01 for definitions of each Condition when determining conditions for other warning signs.

CONDITIONS FOR PLACEMENT OF ADVANCE WARNING SIGNS

Figure 75-4B

VEHICULAR SPEED	BALL-BANK READING	MAXIMUM RECOMMENDED SPEED OF CURVE
20 mph or lower	14° or greater	Speed at which the 14° reading occurs
25 or 30 mph	12°	Speed at which the 12° reading occurs
40 mph or higher	10°	Speed at which the 10° reading occurs

BALL-BANK INDICATOR READINGS

Figure 75-4C

ROUTE	REGIONAL CONTROL CITIES
64	Evansville
65	Gary, Columbus, Lafayette
69	Anderson, Angola
70	Terre Haute, Richmond
74	Crawfordsville, Shelbyville
80	(none)
94	Michigan City, Gary

REGIONAL CONTROL CITIES FOR INTERSTATE ROUTES

Figure 75-5A

ROUTE	NATIONAL CONTROL CITIES
64	St. Louis, Louisville
65	Louisville, Indianapolis, Chicago
69	Indianapolis, Fort Wayne, Lansing
70	St. Louis, Indianapolis, Dayton, Columbus
74	Peoria, Indianapolis, Cincinnati
80	Chicago
94	Chicago, Detroit

NATIONAL CONTROL CITIES FOR INTERSTATE ROUTES

Figure 75-5B

TYPE OF GENERATOR	SPECIFIC CRITERIA Distance From Interchange (mi)			SIGN COLORS
	MAJOR METRO AREA 100,000 OR OVER	URBAN AREA UNDER 100,000	RURAL	
Airports and Colleges				
Airport: City or county owned with regularly scheduled airline service	5	5	5	White on Green
College or University: Fully accredited by Indiana State Regents for Higher Education (Full-time with 700 student enrollment)	5	5	25	White on Green
Vocational-Technical School: Fully accredited by Indiana State Dept. of Vo.-Tech. Education (Full-time with 700 student enrollment)	5	5	5	White on Green
Military Base	MINIMUM 5000 EMPLOYEES AND PERMANENTLY ASSIGNED MILITARY PERSONNEL			
	5			White on Green
Tourist Attractions	ANNUAL ATTENDANCE			
Amusement Park Arena Auditorium Convention Hall Fairground Major Recreational Area Monument Museum Park Stadium State or National Park Zoo	50,000	50,000	50,000	White on Brown
	MINIMUM NUMBER OF SEATS (If Applicable)			
	6,000	6,000	6,000	
	5	5	5	
	Distance may be increased one-half mi for each 15,000 people over the annual attendance listed up to maximum of 25 mi.			
Hospital	MINIMUM NUMBER OF BEDS			
	400	100	100	
Must have at least one resident physician on duty 24 h per day; 7 days per wk	3	5	5	White on Blue
Central Business District	POPULATION (City of 300,000 or More)			
	5			White on Green
Other Incorporated City	POPULATION (City of 3,000 or More)			
	5			White on Green
Toll Highway	LOCATION: DIRECT ACCESS FROM STATE HIGHWAY SYSTEM			
	Toll facility name or marker may be included as part of the major guide sign, where applicable.			White on Green

GUIDELINES FOR SIGNING TRAFFIC GENERATORS ON A FREEWAY

Figure 75-5C

HIGHWAY FACILITY	INTERCHANGE TYPE			
	DIAMOND	PARTIAL CLOVERLEAF	TRUMPET	FULL CLOVERLEAF
Divided highway with partial control of access within limits of signing	Figure 75-5E Figure 75-5F	Figure 75-5M Figure 75-5N	Figure 75-5Q	Figure 75-5 I Figure 75-5J
Multi-lane approach with no control of access within limits of signing	Figure 75-5G Figure 75-5H	Figure 75-5 O Figure 75-5P	Figure 75-5Q	Figure 75-5K Figure 75-5L
One-lane approach (Two-lane highway)	Figure 75-5G Figure 75-5H	Figure 75-5 O Figure 75-5P	Figure 75-5Q	Not Applicable

Note: Sign spacing shown in Figures 75-5E through 75-5Q may be varied to fit local geometric, land use, or traffic conditions.

**FIGURE REFERENCES FOR TYPICAL CROSSROAD SIGNING
AT FREEWAY INTERCHANGE**

Figure 75-5D

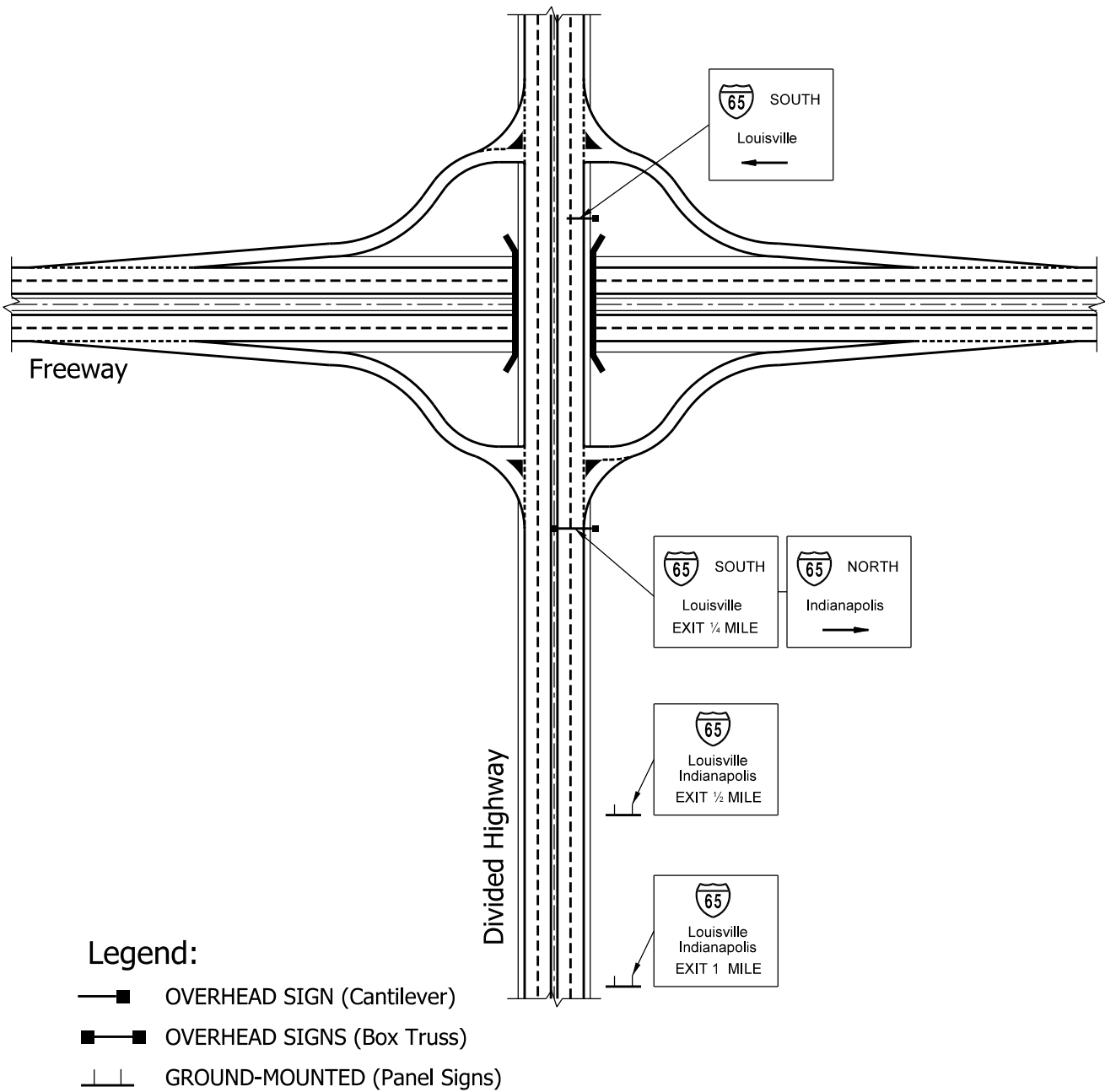

DIAMOND INTERCHANGE SIGNING (Freeway Under Divided Highway)

Figure 75-5E

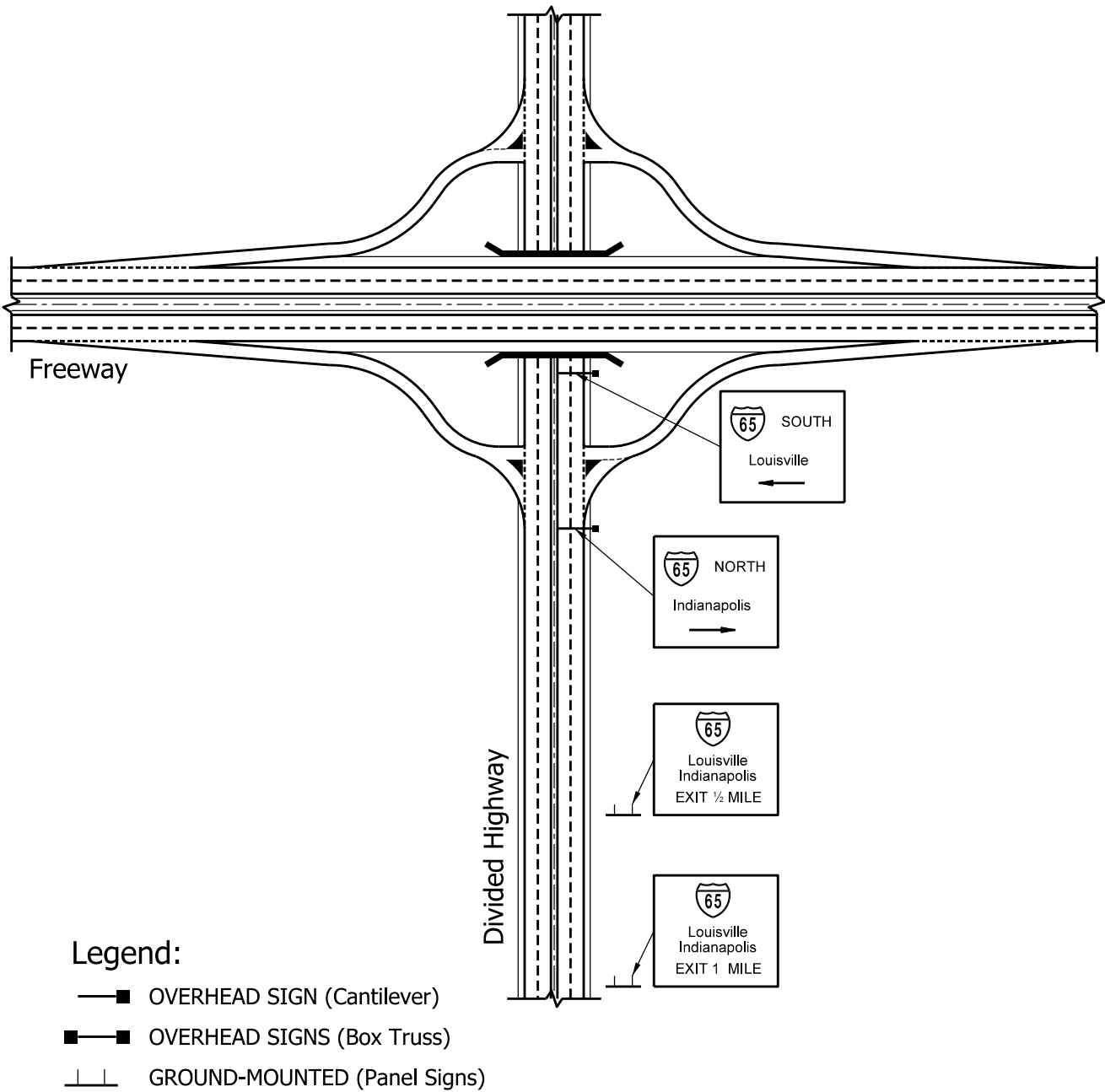

DIAMOND INTERCHANGE SIGNING (Freeway over Divided Highway)

Figure 75-5F

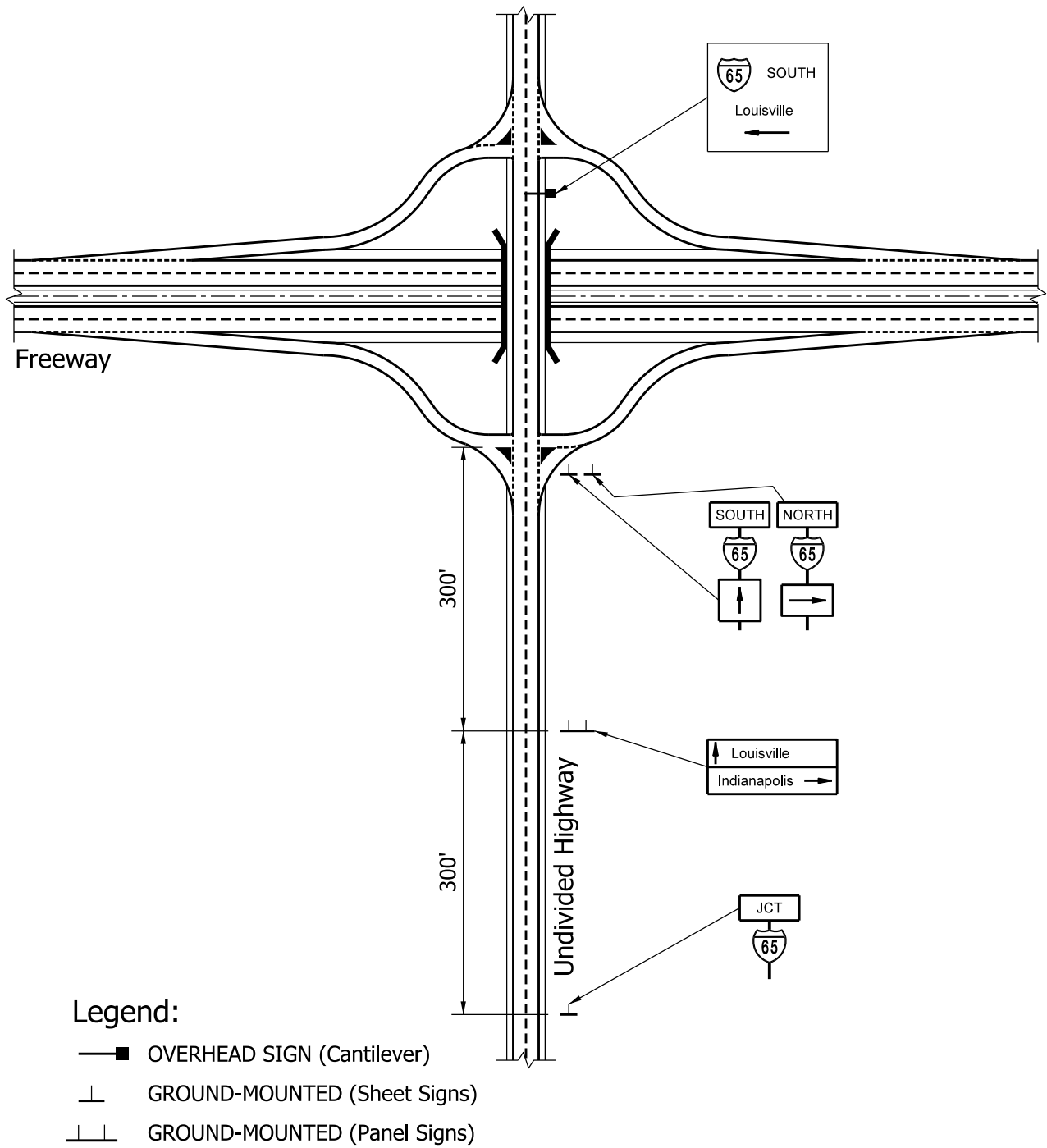

DIAMOND INTERCHANGE SIGNING (Freeway under Undivided Highway)

Figure 75-5G

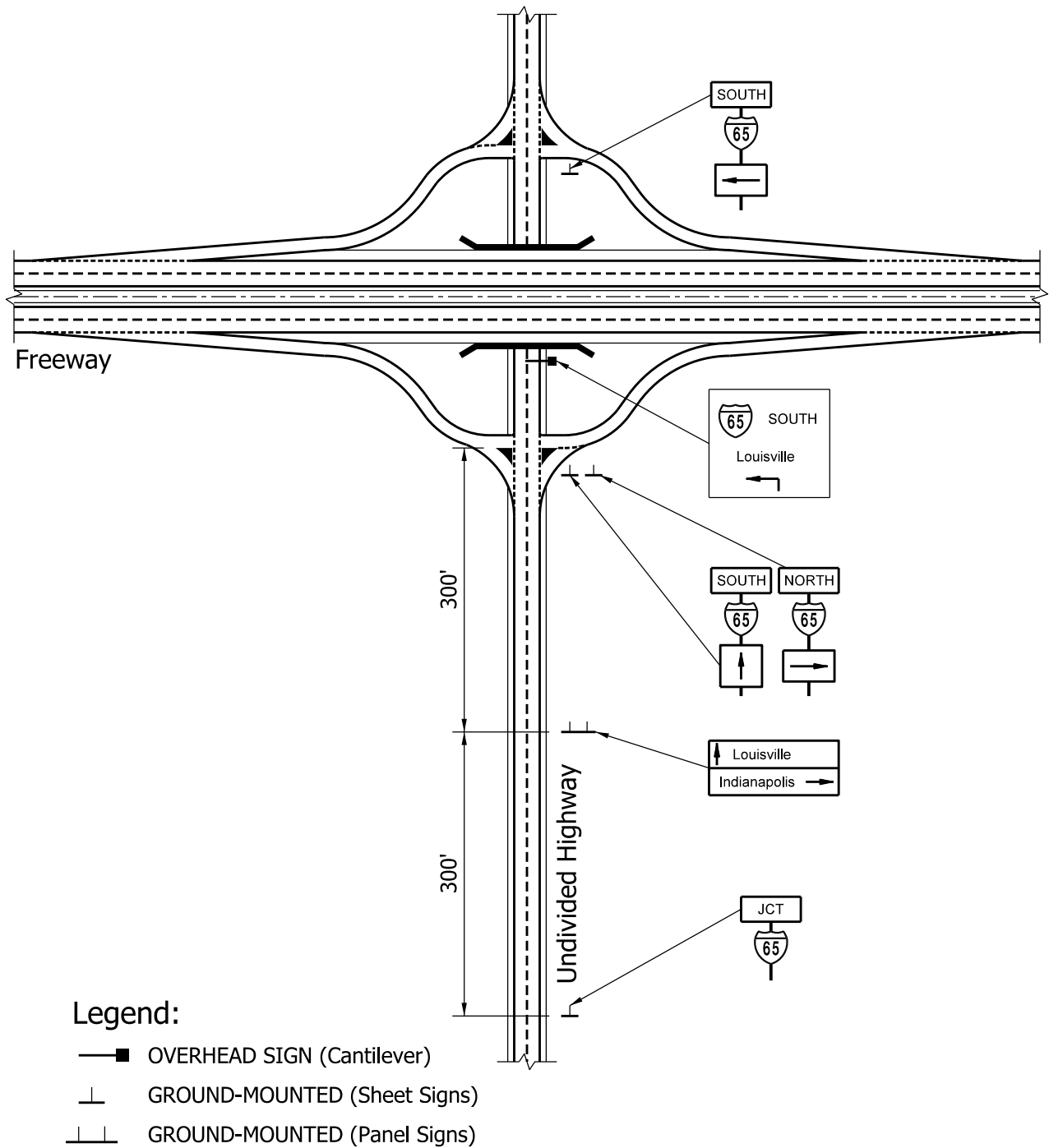

DIAMOND INTERCHANGE SIGNING (Freeway over Undivided Highway)

Figure 75-5H

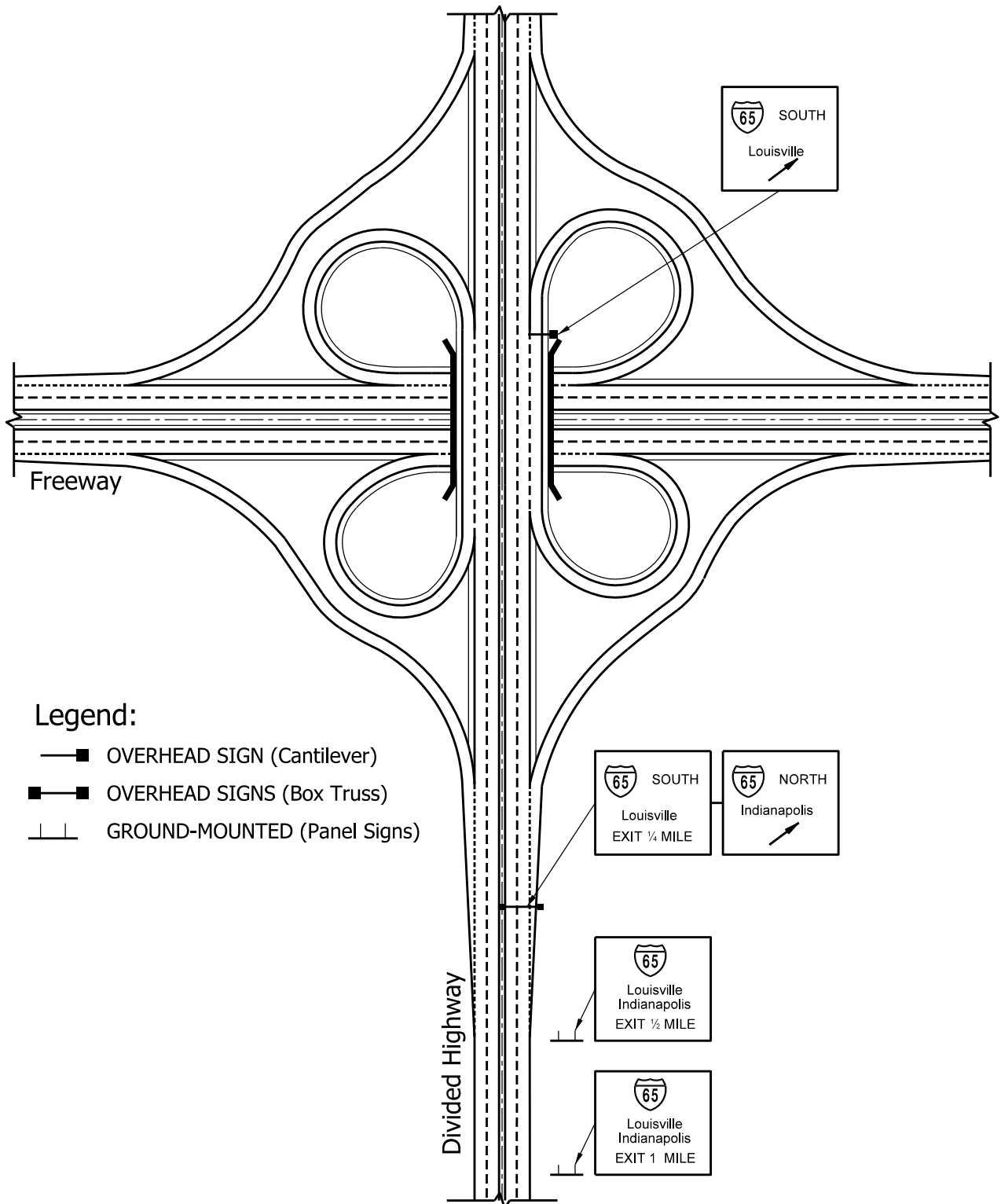

FULL CLOVERLEAF INTERCHANGE SIGNING (Freeway under Divided Highway)

Figure 75-5 I

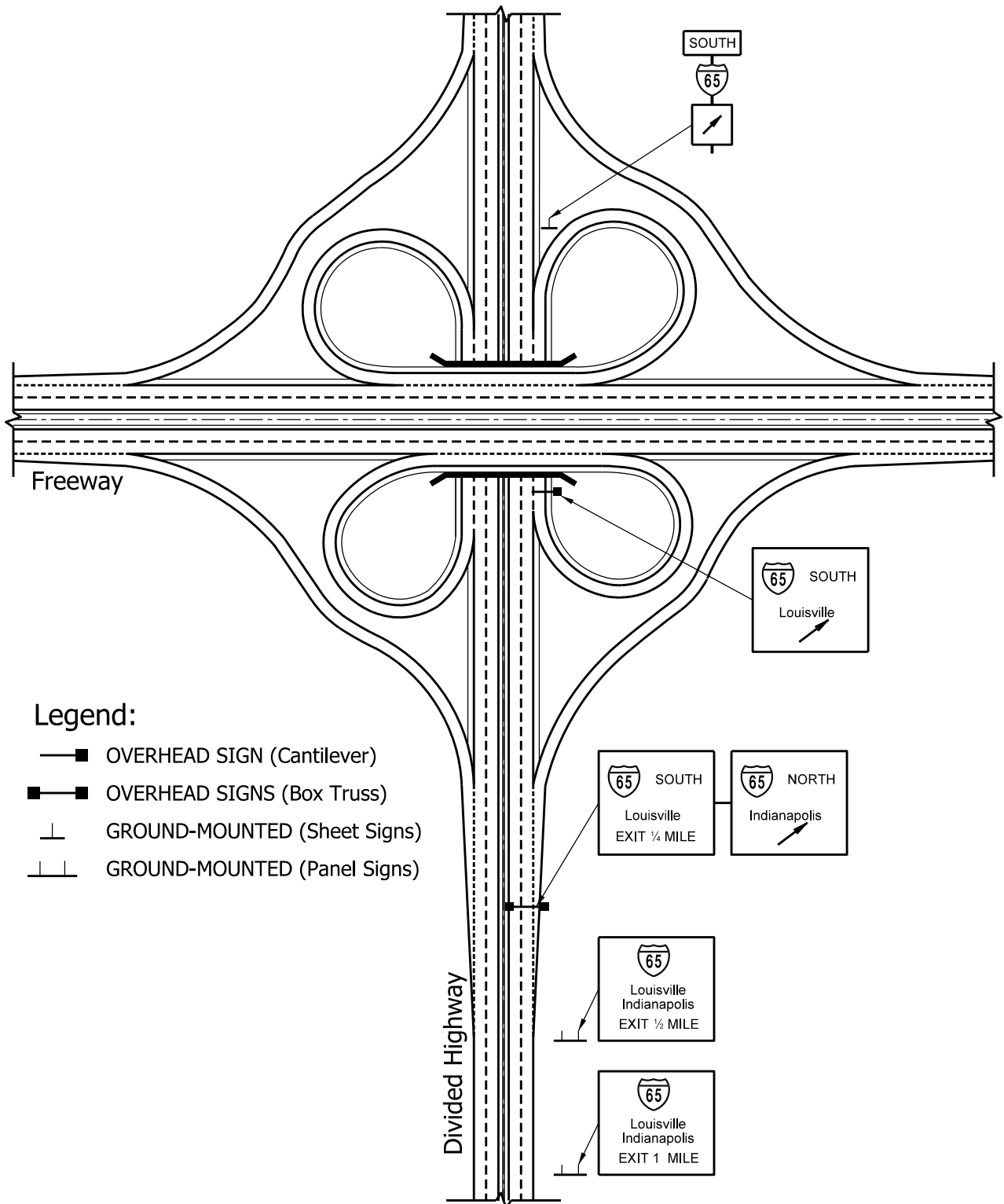

**FULL CLOVERLEAF INTERCHANGE SIGNING
(Freeway over Divided Highway)**

Figure 75-5J

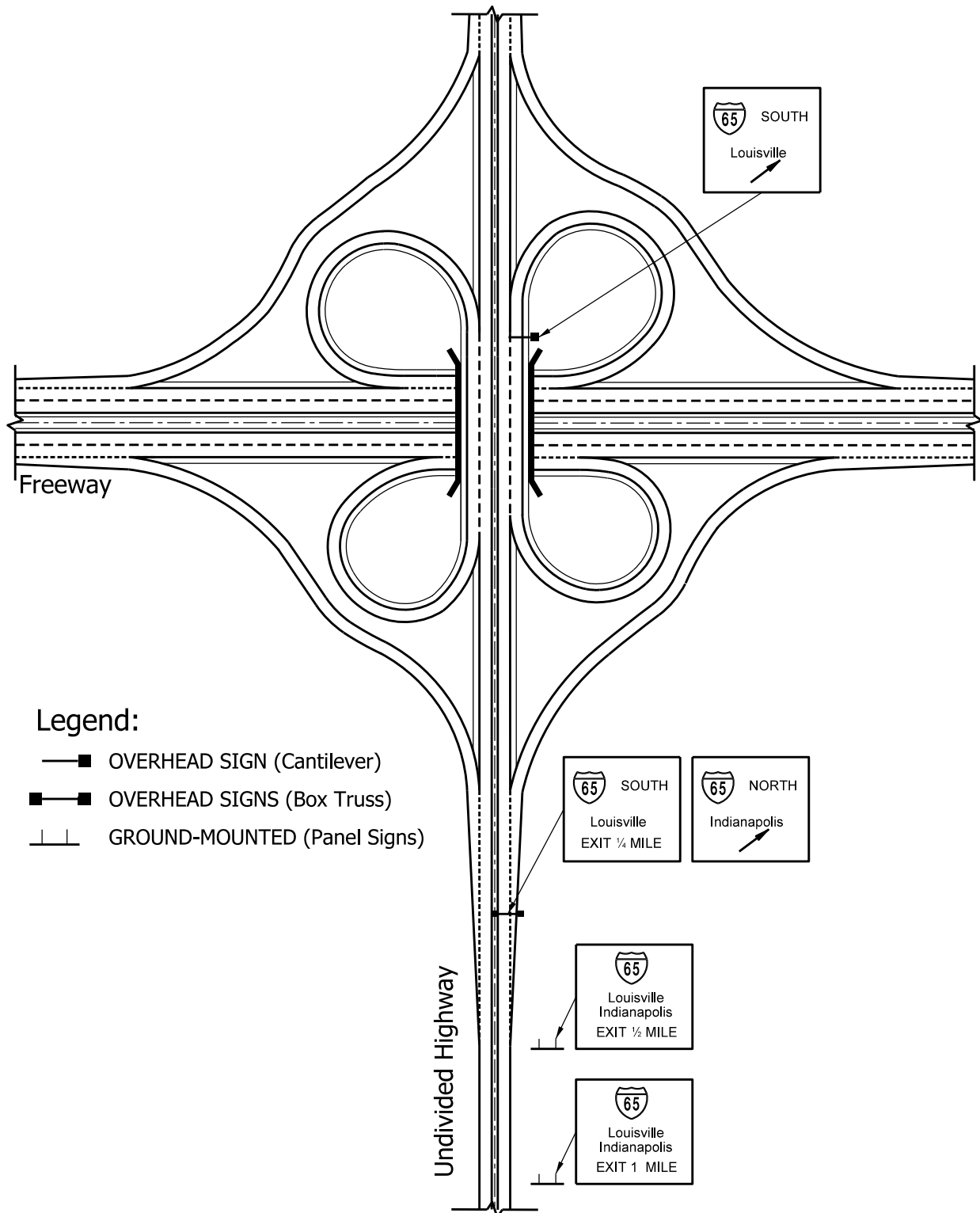

FULL CLOVERLEAF INTERCHANGE SIGNING (Freeway under Undivided Highway)

Figure 75-5K

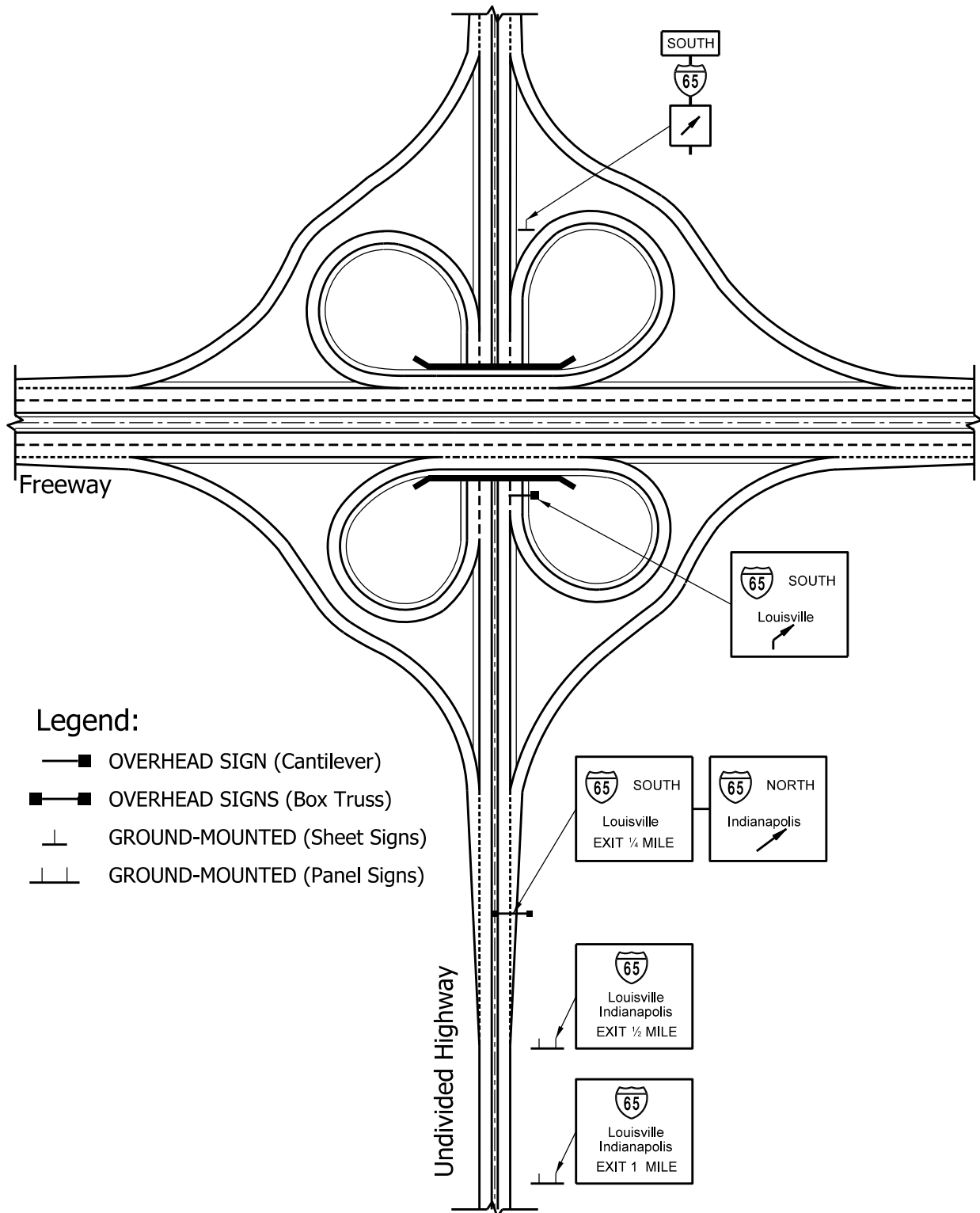

**FULL CLOVERLEAF INTERCHANGE SIGNING
(Freeway over Undivided Highway)**

Figure 75-5L

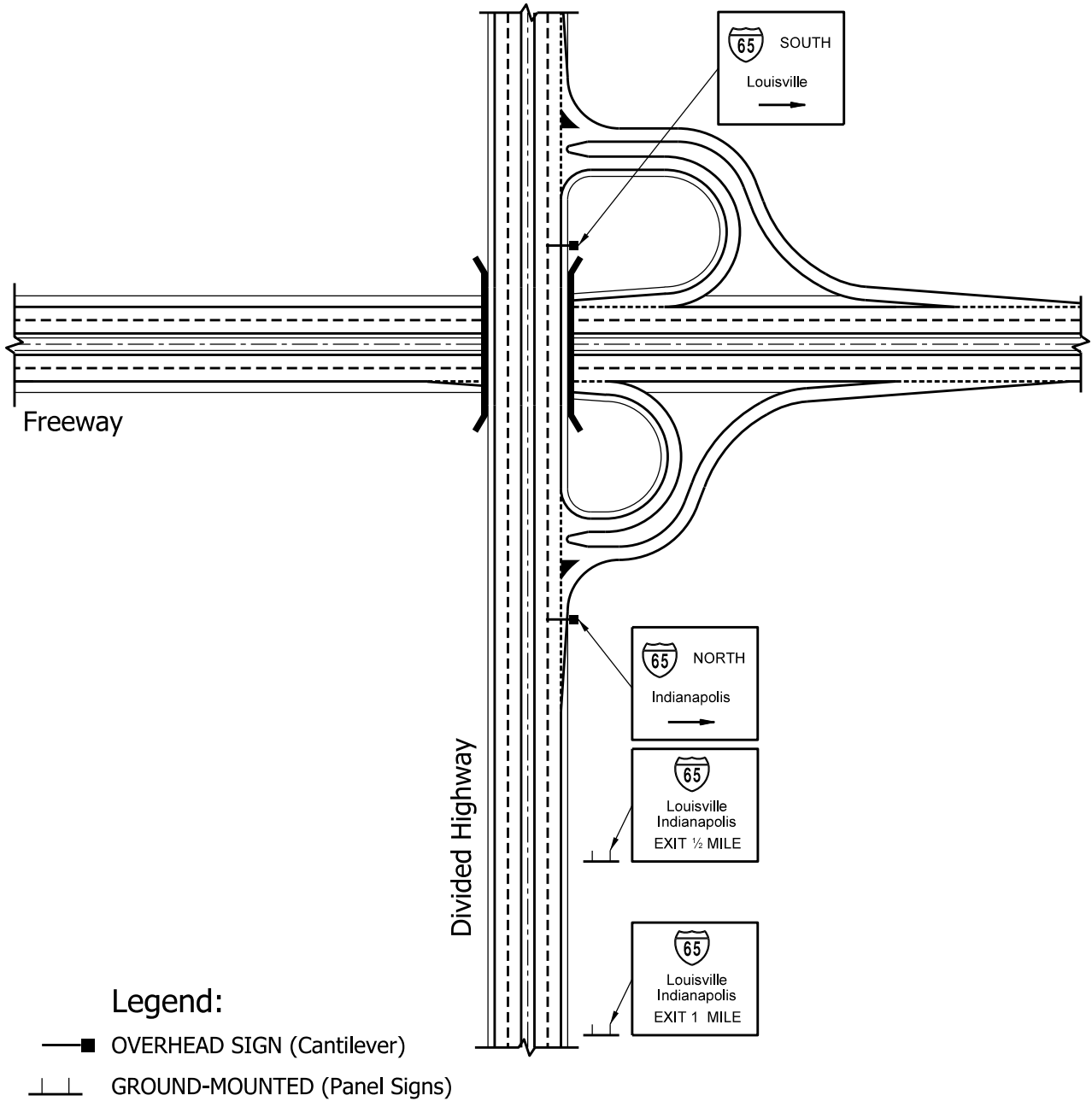

PARTIAL CLOVERLEAF INTERCHANGE SIGNING (Freeway under Divided Highway)

Figure 75-5M

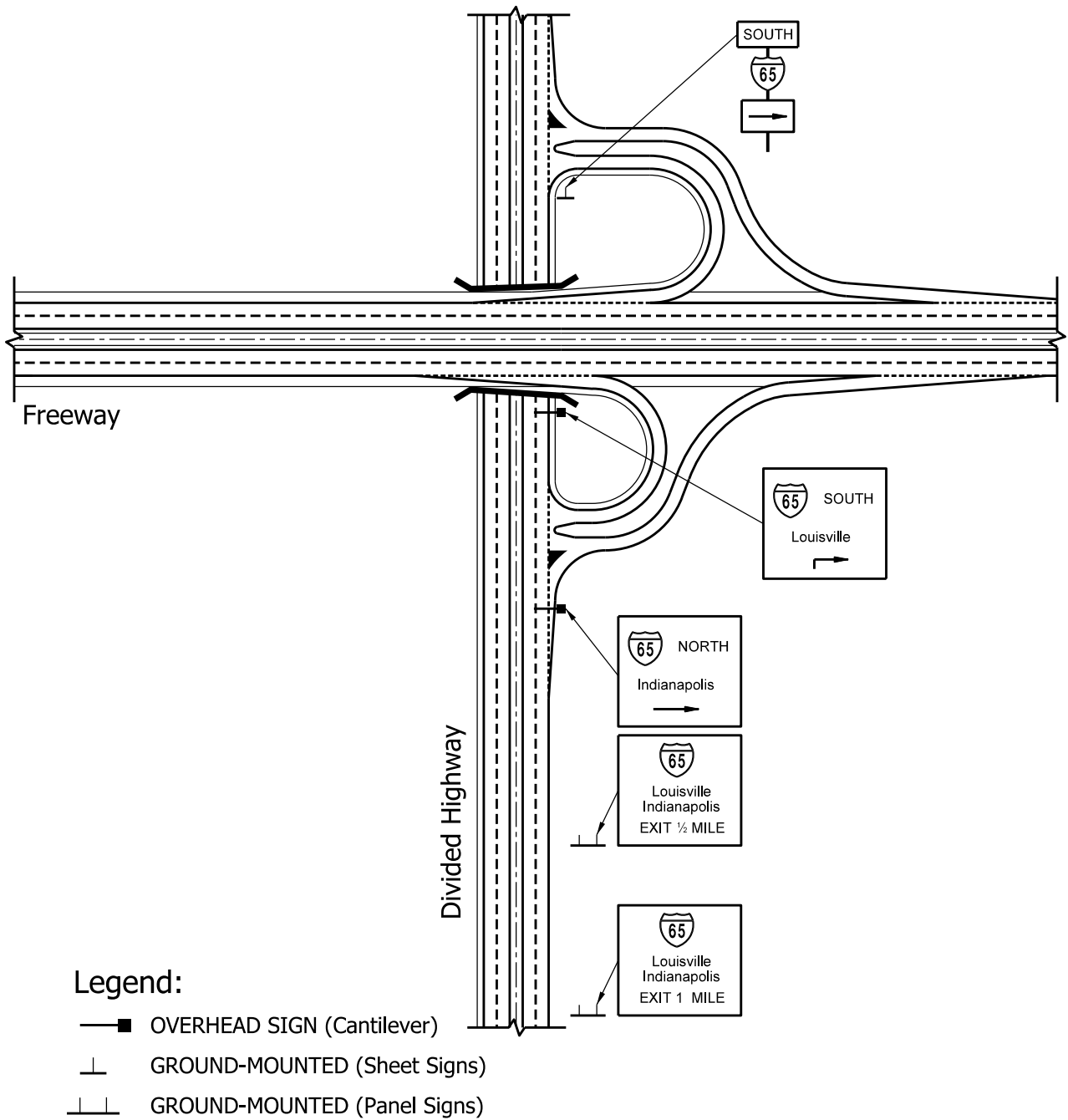

**PARTIAL CLOVERLEAF INTERCHANGE SIGNING
(Freeway over Divided Highway)**

Figure 75-5N

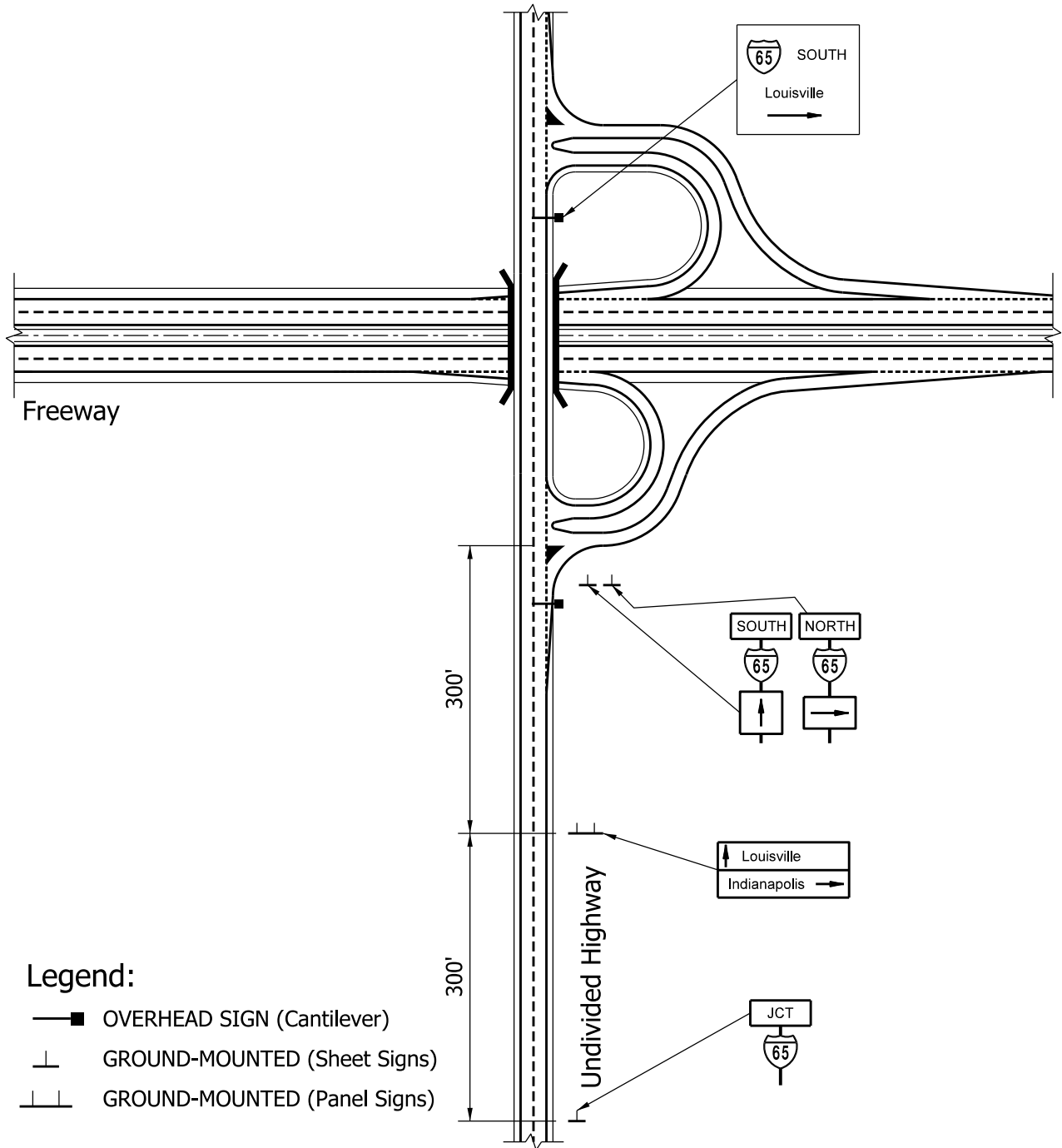

PARTIAL CLOVERLEAF INTERCHANGE SIGNING (Freeway under Undivided Highway)

Figure 75-5 O

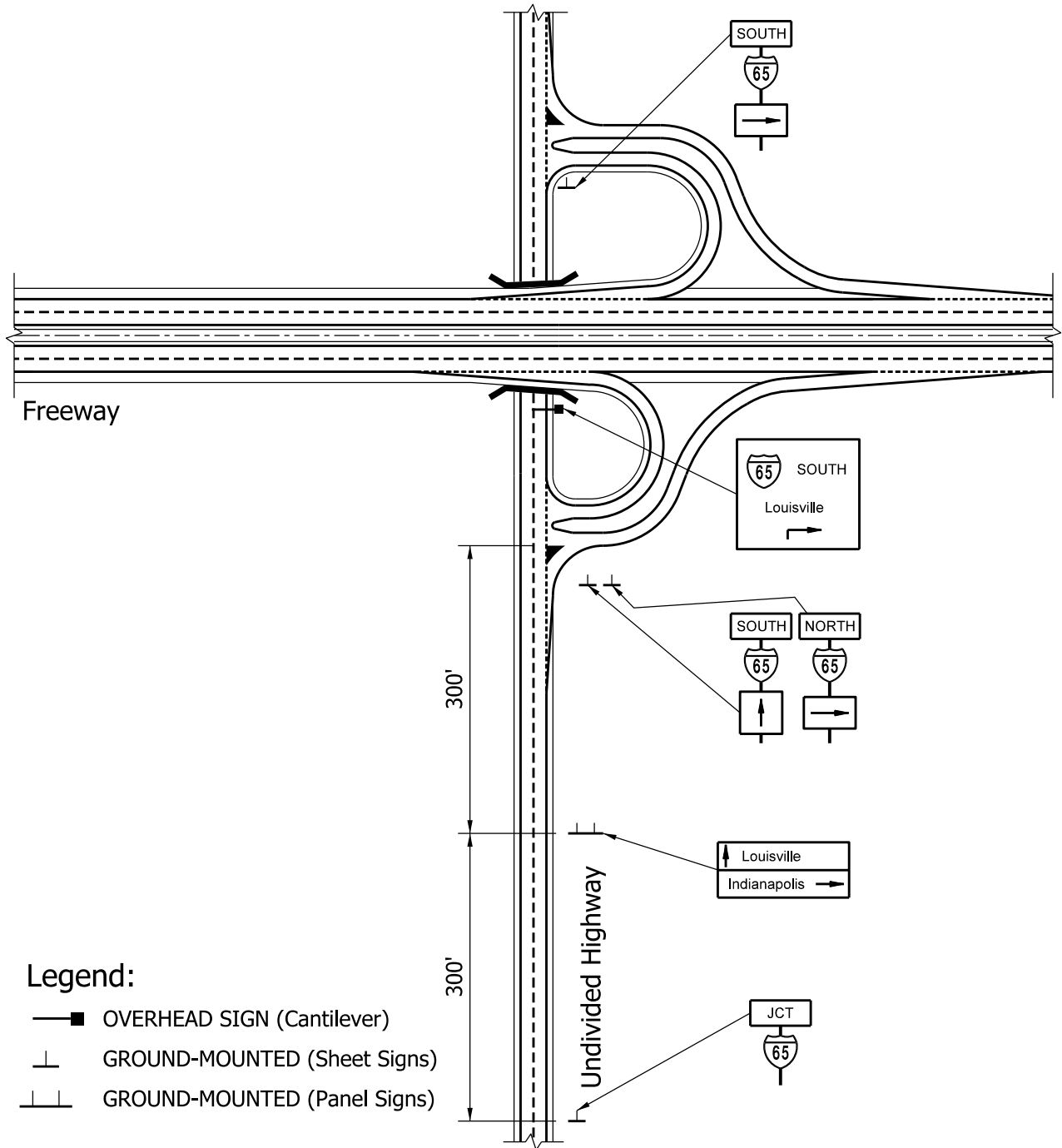

**PARTIAL CLOVERLEAF INTERCHANGE SIGNING
(Freeway over Undivided Highway)**

Figure 75-5P

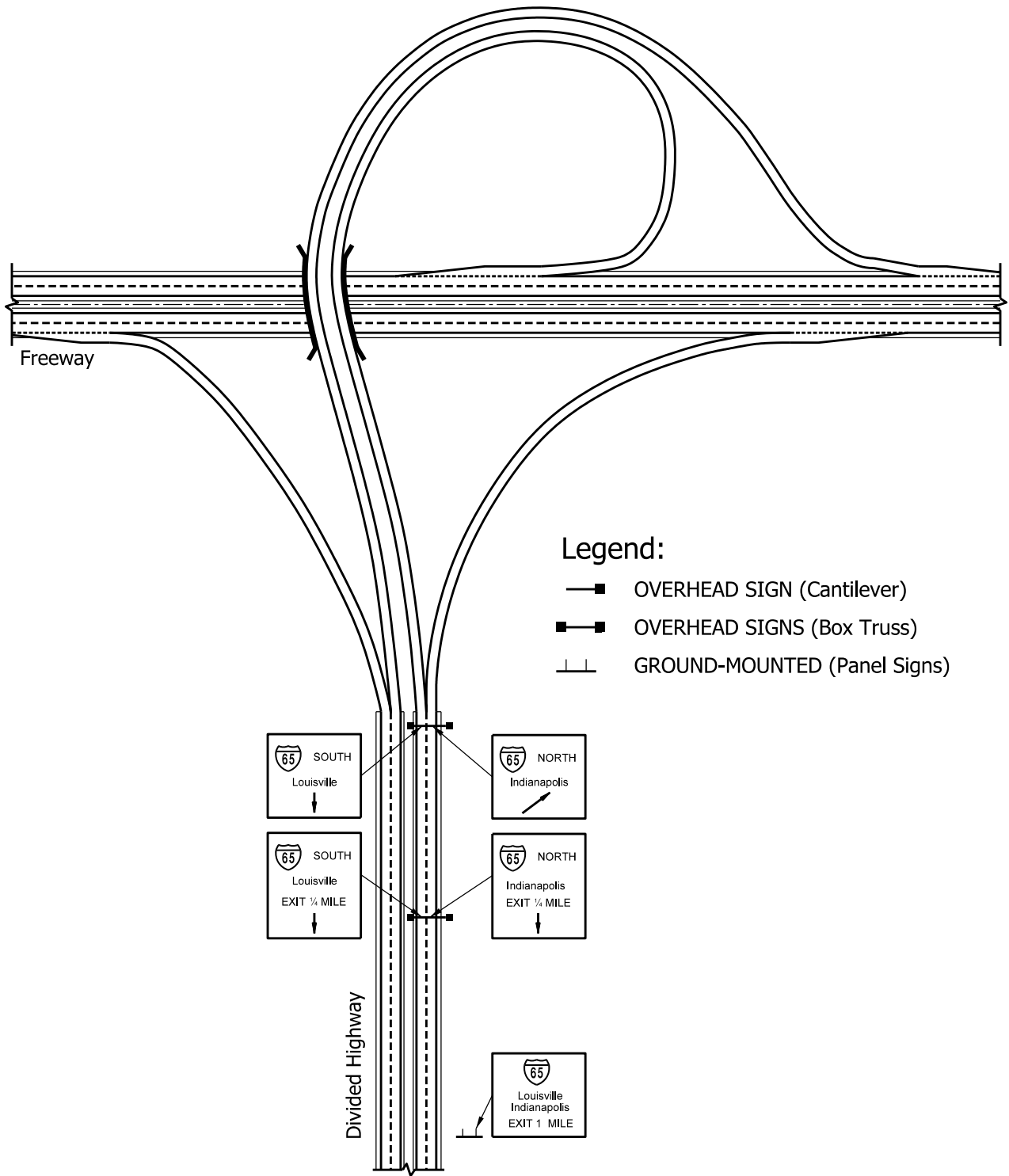

**TRUMPET INTERCHANGE SIGNING
SYSTEM
(One Road Terminates)**

Figure 75-5Q