

PLAN

NOTES:

1. See Standards Drawing E 601-GCTA-02 for Details A and B.

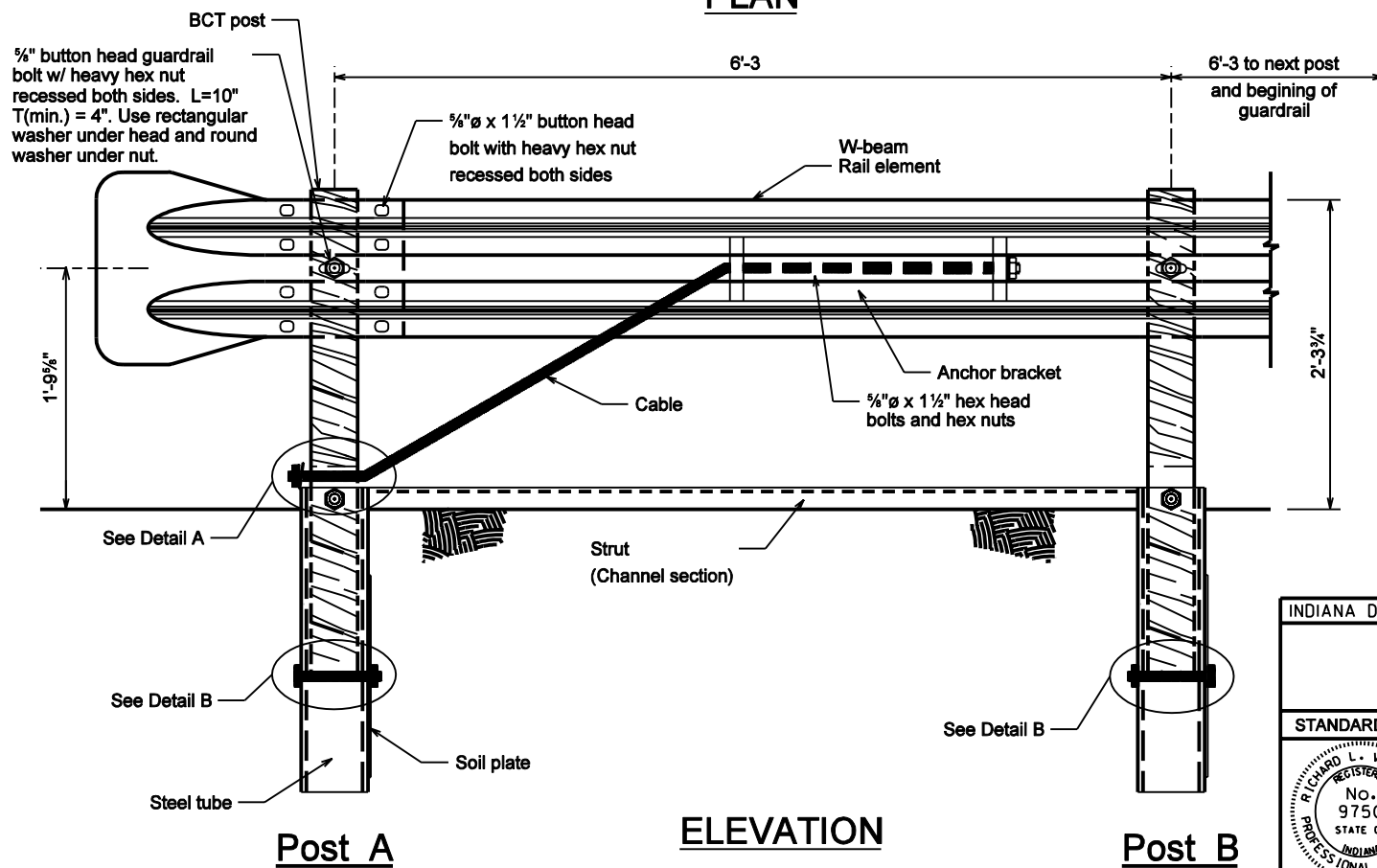

ELEVATION

INDIANA DEPARTMENT OF TRANSPORTATION	
CABLE TERMINAL ANCHOR SYSTEM	
SEPTEMBER 2001	
STANDARD DRAWING NO. E 601-GCTA-01	
	/s/ Richard L. VanCleave 9-04-01 DESIGN STANDARDS ENGINEER DATE
	/s/ Firooz Zandl 9-04-01 CHIEF HIGHWAY ENGINEER DATE
DESIGN STANDARDS ENGINEER	

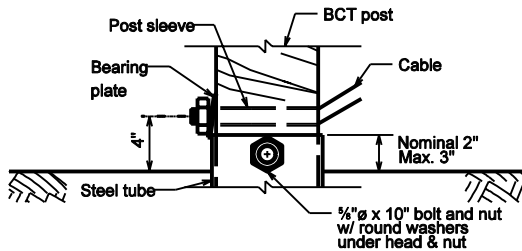

DETAIL A

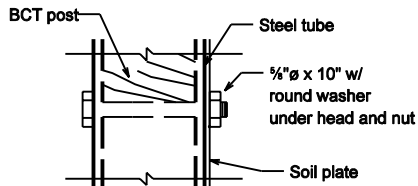

DETAIL B

INDIANA DEPARTMENT OF TRANSPORTATION	
CABLE TERMINAL ANCHOR SYSTEM	
SEPTEMBER 2001	
STANDARD DRAWING NO. E 601-GCTA-02	
	/s/ Richard L. VanCleave DESIGN STANDARDS ENGINEER 9-04-01 DATE
	/s/ Fitzroy Zandl CHIEF HIGHWAY ENGINEER 9-04-01 DATE
DESIGN STANDARDS ENGINEER	

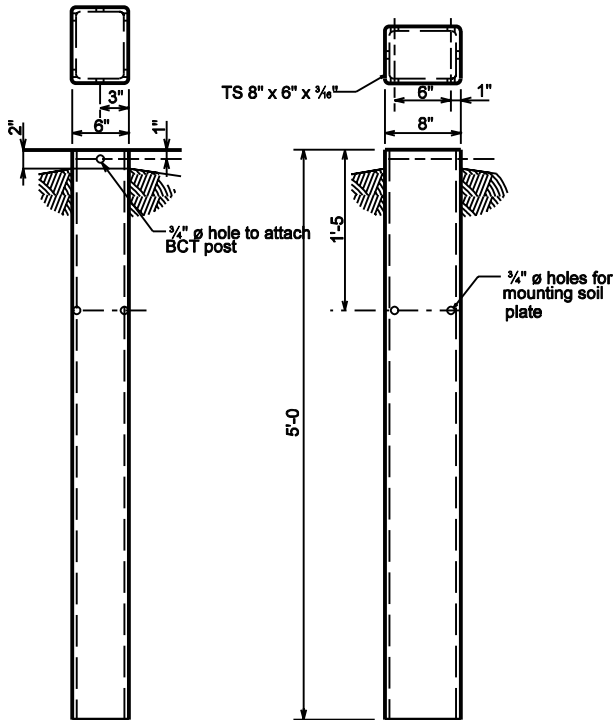

FRONT **SIDE**
GALVANIZED STEEL
FOUNDATION TUBE

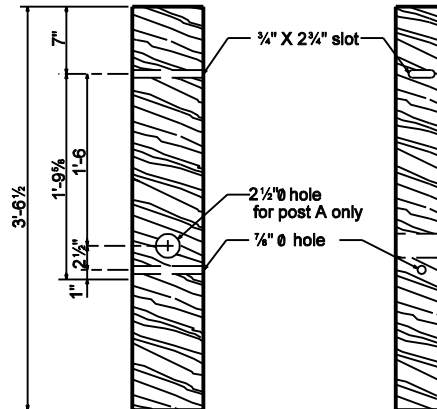
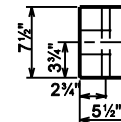

SIDE **FRONT**
BCT TIMBER POST

INDIANA DEPARTMENT OF TRANSPORTATION

**CABLE TERMINAL
ANCHOR SYSTEM**

SEPTEMBER 2001

STANDARD DRAWING NO. E 601-GCTA-03

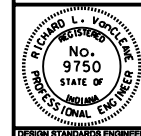

/s/ Richard L. VanCleave 9-04-01
DESIGN STANDARDS ENGINEER DATE

/s/ Fitzroy Zandl 9-04-01
CHIEF HIGHWAY ENGINEER DATE

DESIGN STANDARDS ENGINEER

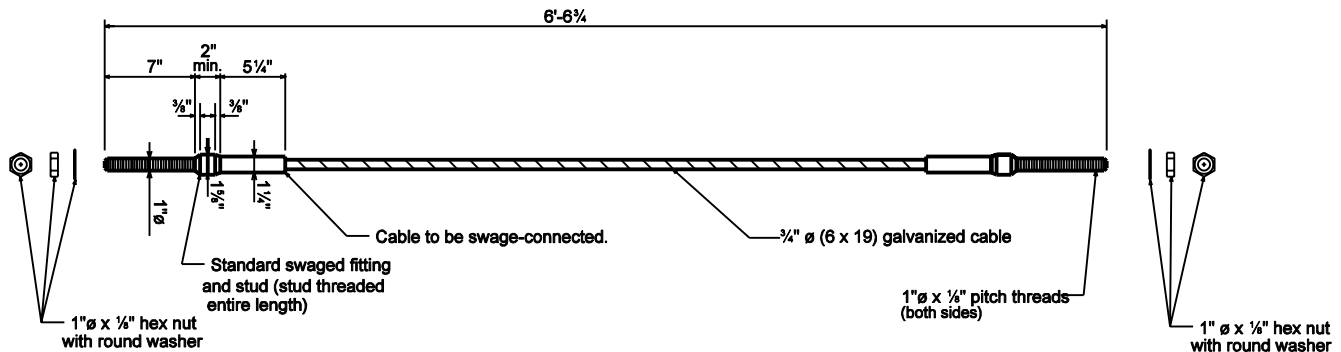

BCT CABLE ANCHOR ASSEMBLY

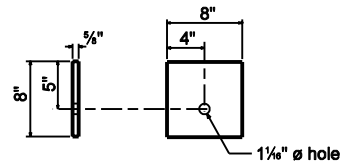

BCT BEARING PLATE

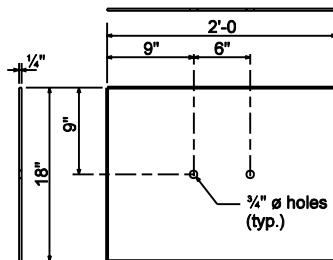

FOUNDATION TUBE SOIL PLATE

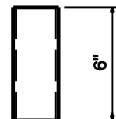
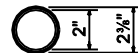

BCT POST SLEEVE

INDIANA DEPARTMENT OF TRANSPORTATION

CABLE TERMINAL
ANCHOR SYSTEM

SEPTEMBER 2001

STANDARD DRAWING NO. E 601-GCTA-04

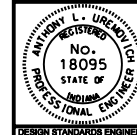

/s/ Anthony L. Uremowich 9-04-01
DESIGN STANDARDS ENGINEER DATE

/s/ Firas Zard 9-04-01
CHIEF HIGHWAY ENGINEER DATE

DESIGN STANDARDS ENGINEER

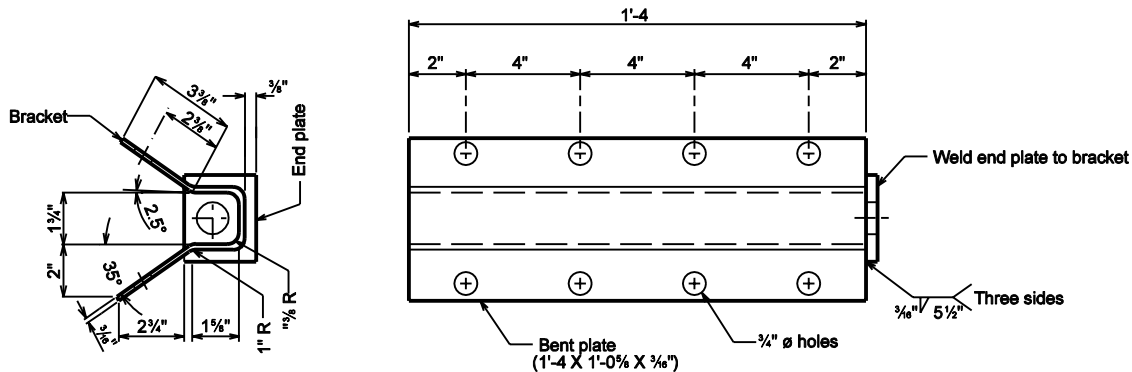

BRACKET

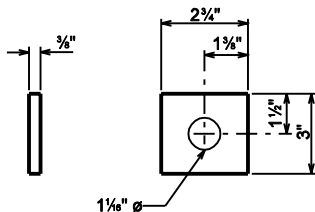

END PLATE

GUARDRAIL ANCHOR BRACKET

INDIANA DEPARTMENT OF TRANSPORTATION	
CABLE TERMINAL ANCHOR SYSTEM	
SEPTEMBER 2001	
STANDARD DRAWING NO. E 601-GCTA-05	
	/s/ Richard L. VarCleave DESIGN STANDARDS ENGINEER DATE 9-04-01
	/s/ Firooz Zandi CHIEF HIGHWAY ENGINEER DATE 9-04-01

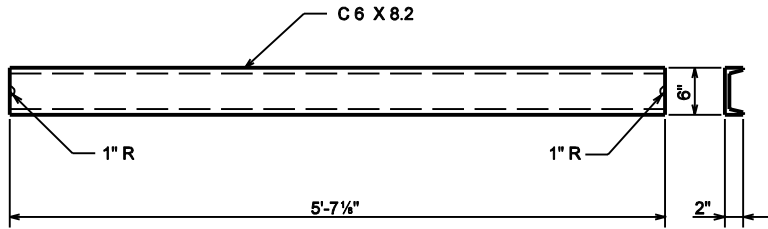

STRUT DETAILS

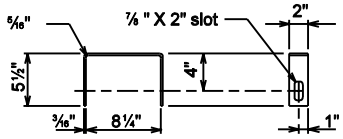

YOKE DETAILS

(2 required)

STRUT AND YOKE ASSEMBLY

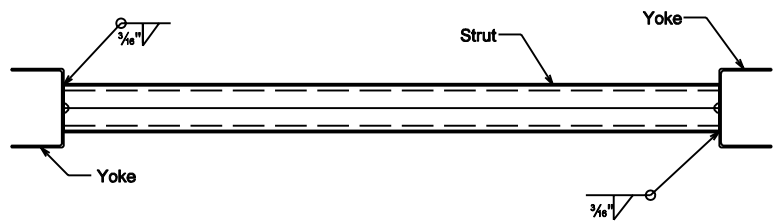

ASSEMBLY DETAILS

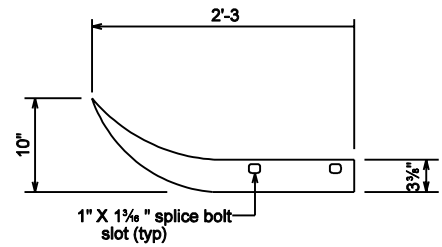

PLAN

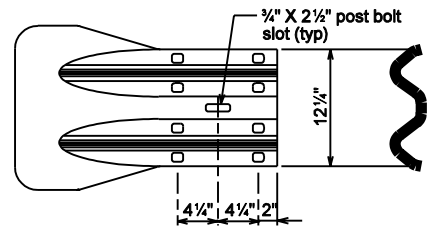

ELEVATION

FLARED W-BEAM END SECTION

INDIANA DEPARTMENT OF TRANSPORTATION	
CABLE TERMINAL ANCHOR SYSTEM	
SEPTEMBER 2001	
STANDARD DRAWING NO. E 601-GCTA-06	
	/s/ Richard L. VarCleave DESIGN STANDARDS ENGINEER DATE
	/s/ Firooz Zandi CHIEF HIGHWAY ENGINEER DATE