

PLAN

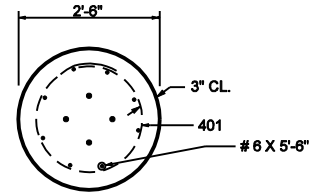

SECTION A-A

Notes:

1. Junction box shall meet the following specifications:
 - a. Material: Polymer concrete
 - b. Color: Concrete gray
 - c. Cover rating: 20,000 lbs.

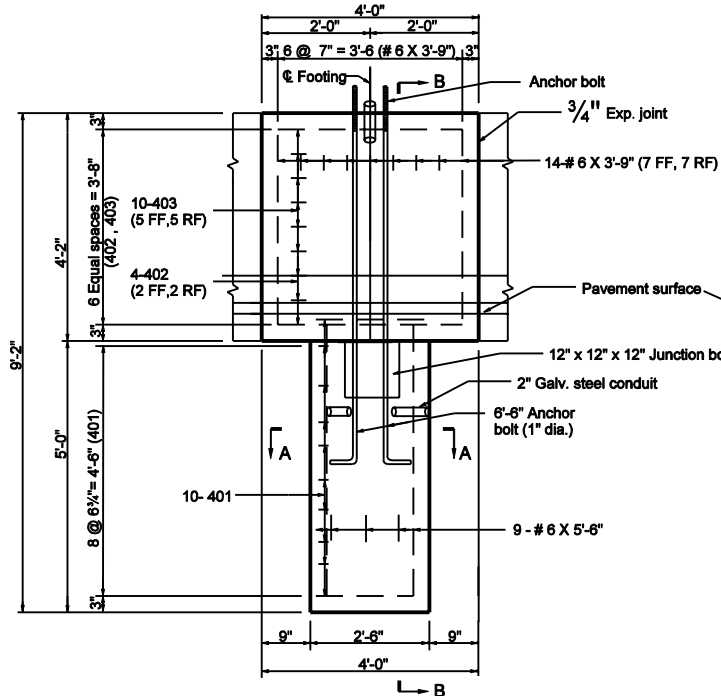

ELEVATION

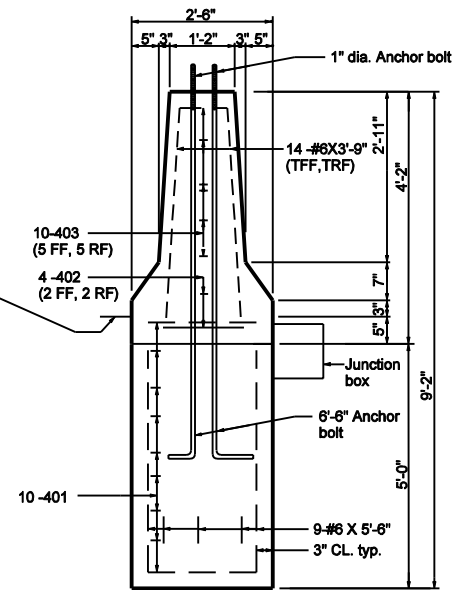

SECTION B-B

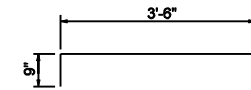

403 X 5'-0"

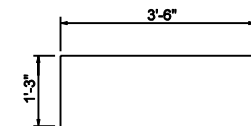

402 X 6'-0"

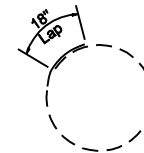

401 X 8'-10"

INDIANA DEPARTMENT OF TRANSPORTATION
 CONVENTIONAL LIGHT FOUNDATION
 FOR 45" CONCRETE MEDIAN WALL
 INSTALLATION.
 SEPTEMBER 2002

STANDARD DRAWING NO. E 807-LTFD-10

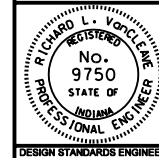

/s/ Richard L. VanCleave 9-03-02
 DESIGN STANDARDS ENGINEER DATE

/s/ Richard K. Smutzer 9-03-02
 CHIEF HIGHWAY ENGINEER DATE

DESIGN STANDARDS ENGINEER