

SECTION A-A CONNECTION VIEW

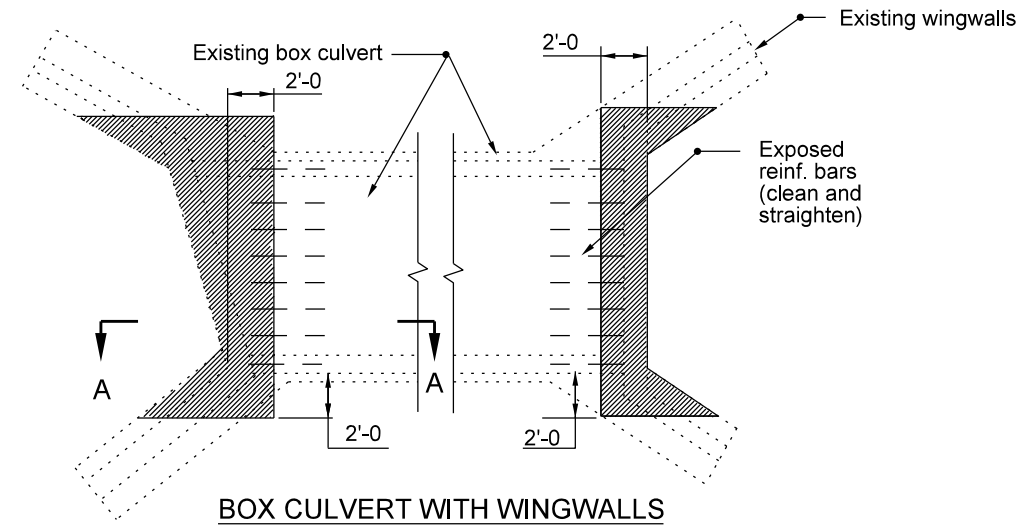

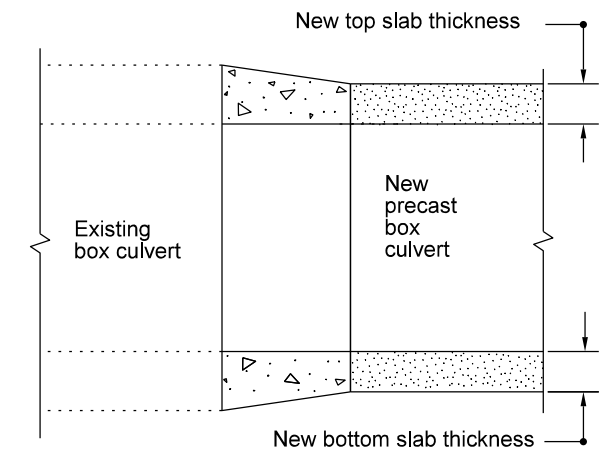

BOX CULVERT WITH WINGWALLS
EXTENSION PREPARATION



SECTION A-A AND B-B
(Showing cast-in-place section)

LEGEND :

-  Removal
-  Existing structure
-  New element or structure

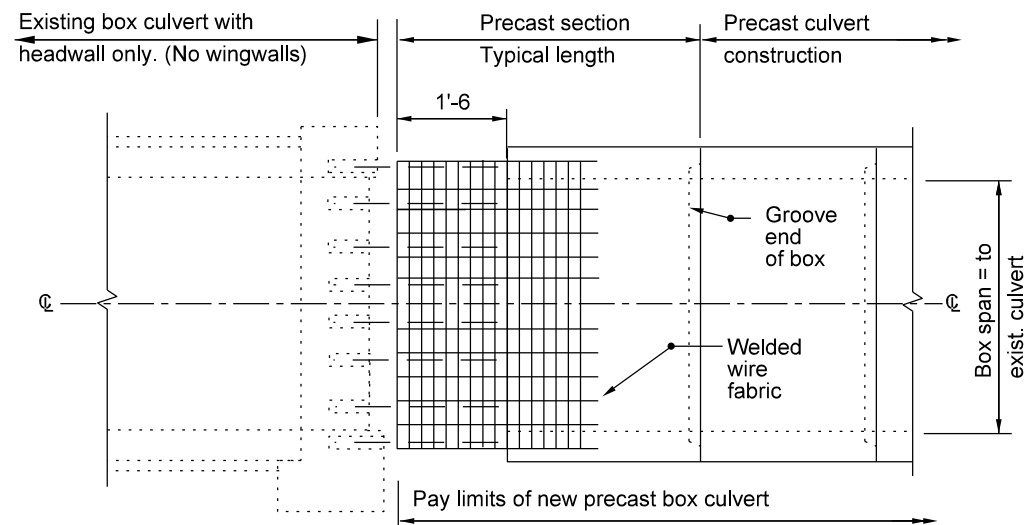

SECTION B-B CONNECTION VIEW

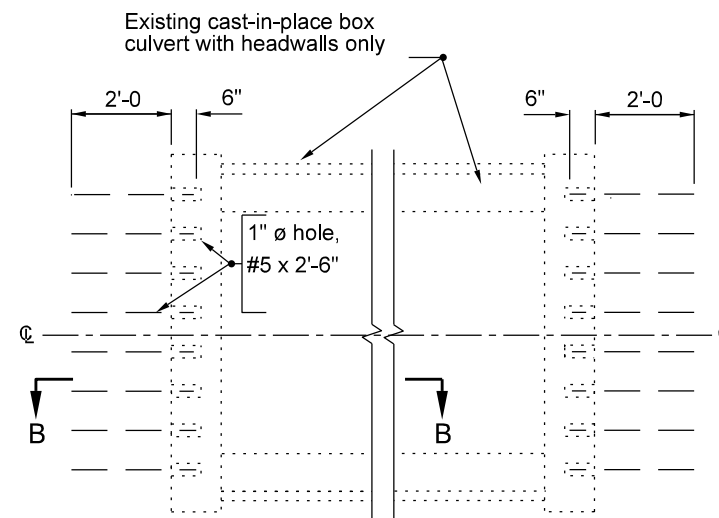

BOX CULVERT WITH HEADWALLS ONLY
EXTENSION PREPARATION

INDIANA DEPARTMENT OF TRANSPORTATION

PRECAST BOX-CULVERT EXTENSION

SEPTEMBER 2009

STANDARD DRAWING NO. E 714-BCEX-01

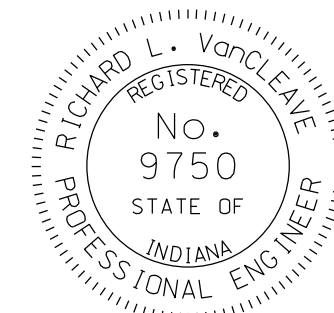

DESIGN STANDARDS ENGINEER

/s/ Richard L. VanCleave 09/01/09
DESIGN STANDARDS ENGINEER DATE

/s/ Mark A. Miller 09/01/09
CHIEF HIGHWAY ENGINEER DATE