

Presby Wastewater Treatment Systems

Indiana

Design and Installation Manual

for

Advanced Enviro-Septic® Wastewater Treatment System



✓ **Minimizes the Expense**

✓ **Protects the Environment**

✓ **Preserves the Site**



Presby Environmental, Inc.

An Infiltrator Water Technologies Company
The Next Generation of Wastewater Treatment Technology

143 Airport Rd., Whitefield, NH 03598
Tel: 800-473-5298 Fax: 603-837-9864
info@presbyeco.com
www.PresbyEnvironmental.com

The information in this manual is subject to change without notice. We recommend that you check your state's page on our website on a regular basis for updated information. Your suggestions and comments are welcome. Please contact us at: 800-473-5298.

Presby Environmental, Inc.
143 Airport Road
Whitefield, NH 03598
Phone: 1-800-473-5298 Fax: (603) 837-9864
Website: www.PresbyEnvironmental.com

The products and methods depicted in this manual are protected by one or more patents. For more information:
Pat. www.presbyeco.com/patents.

**Advanced Enviro-Septic® is a registered trademark of Presby Environmental Inc.
Enviro-Septic® is a registered trademark of Presby Environmental, Inc.
Simple-Septic® is a registered trademark of Presby Environmental Inc.**

IMPORTANT NOTICE: This Manual is intended **ONLY** for use in designing and installing Presby Environmental's Advanced Enviro-Septic® Wastewater Treatment System. The use of this Manual with any other product is prohibited. The processes and design criteria contained herein are based solely on our experience with and testing of Advanced Enviro-Septic®. Substitution of any other large diameter gravelless pipe will result in compromised treatment of wastewater and other adverse effects.

**© Presby Environmental, Inc. August 2019
All Rights Reserved**

TABLE OF CONTENTS

<u>Number</u>		<u>Page Number</u>
1.0	Background	1
2.0	Ten Stages of Wastewater Treatment	2
3.0	AES System Components.....	3
4.0	Introduction.....	3
5.0	Design Criteria.....	4
6.0	Indiana State Specific Information	5
7.0	Basic Serial Distribution	8
8.0	Combination Serial Distribution.....	9
9.0	Butterfly Configuration.....	10
10.0	Curved Beds.....	11
11.0	90° Beds.....	11
12.0	Multiple Bed Distribution	11
13.0	Non-Conventional System Configurations	12
14.0	Subsurface Drainage, Surface Diversions and Segment Drains	12
15.0	Table A – Pipe Required	13
16.0	Table B – System Sand Bed Area (SSBA) Required	13
17.0	Table C: System Pipe Row Length and Pipe Layout Width (PLW)	14
18.0	Design Procedure (Single Bed).....	14
19.0	Pumping & Dosing	18
20.0	Venting Requirements.....	19
21.0	Site Selection	21
22.0	Installation Requirements, Component Handling and Site Preparation	22
23.0	System Bacteria Rejuvenation and Expansion	25
24.0	Operation & Maintenance	25
25.0	Glossary	26
26.0	Indiana System Installation Form.....	30

1.0 Background

Liquid that exits from a septic tank ("effluent") contains suspended solids that can cause traditional systems to fail prematurely. Solids can overload bacteria, cut off air required for aerobic bacterial activity, and/or seal the underlying soil, interfering with its ability to absorb liquid. By utilizing simple yet effective natural processes, the Advanced Enviro-Septic® Wastewater Treatment System treats septic tank effluent in a manner that prevents suspended solids from sealing the underlying soil, increases system aeration, and provides a greater bacterial treatment area ("biomat") than traditional systems.

1.1 Why Our System Excels

The Advanced Enviro-Septic® Wastewater Treatment System retains solids in its pipe and provides multiple bacterial surfaces to treat effluent prior to its contact with the soil. The continual cycling of effluent (the rising and falling of liquid inside the pipe) enhances bacterial growth. This all combines to create a unique eco-system that no other passive wastewater treatment system is designed to offer. The result is a system that excels by being more efficient, last longer, and have a minimal environmental impact.

1.2 System Advantages

- a) costs less than traditional systems
- b) eliminates the need for washed stone
- c) often requires a smaller area
- d) installs more easily and quickly than traditional systems
- e) adapts easily to residential and commercial sites of virtually any size
- f) adapts well to difficult sites
- g) develops a protected receiving surface preventing sealing of the underlying soil
- h) blends system into sloping terrain
- i) increases system performance and longevity
- j) tests environmentally safer than traditional systems
- k) recharges groundwater more safely than traditional systems
- l) made from recycled plastic

1.3 Patented Technology

At the heart of Advanced Enviro-Septic® (AES) is a patented corrugated, perforated plastic pipe with interior skimmer tabs and cooling ridges. AES pipe is surrounded by three filtering, treatment and dispersal layers (see further product descriptions below). AES pipes are assembled and installed in a bed of specified System Sand (IN DOT 23 sand) which can either be below the ground or above. AES systems are completely passive in their treatment of wastewater, requiring no electricity, motors, alarms, computers, etc.

1.4 Advanced Enviro-Septic® (AES)

The Advanced Enviro-Septic pipe is assembled into an onsite wastewater treatment system that has been successfully tested and certified to NSF 40, Class I (a certification typically given to mechanical aeration devices), BNQ of Quebec, Class I, II, III and Cebedeau, Belgium standards. Advanced Enviro-Septic is comprised of corrugated, perforated plastic pipe, Bio-Accelerator® fabric along its bottom which is surrounded by a layer of randomized plastic fibers and a sewn geo-textile fabric. Advanced Enviro-Septic creates an eco-system designed to simultaneously purify and disperse effluent after primary treatment by a septic tank. Advanced Enviro-Septic is the "next generation" of our Enviro-Septic® technology. The AES product incorporates Bio-Accelerator, a proprietary enhancement that screens additional solids from effluent, accelerates treatment processes, assures even distribution and provides additional surface area. Each foot of Advanced Enviro-Septic provides over 40 sq. ft. of total surface area for bacterial activity. Caution: see para. 6.7, pg. 6 concerning product substitutions.

2.0 Ten Stages of Wastewater Treatment

The Advanced Enviro-Septic® Wastewater Treatment System's

10 STAGES OF TREATMENT

Advance Enviro-Septic (AES)

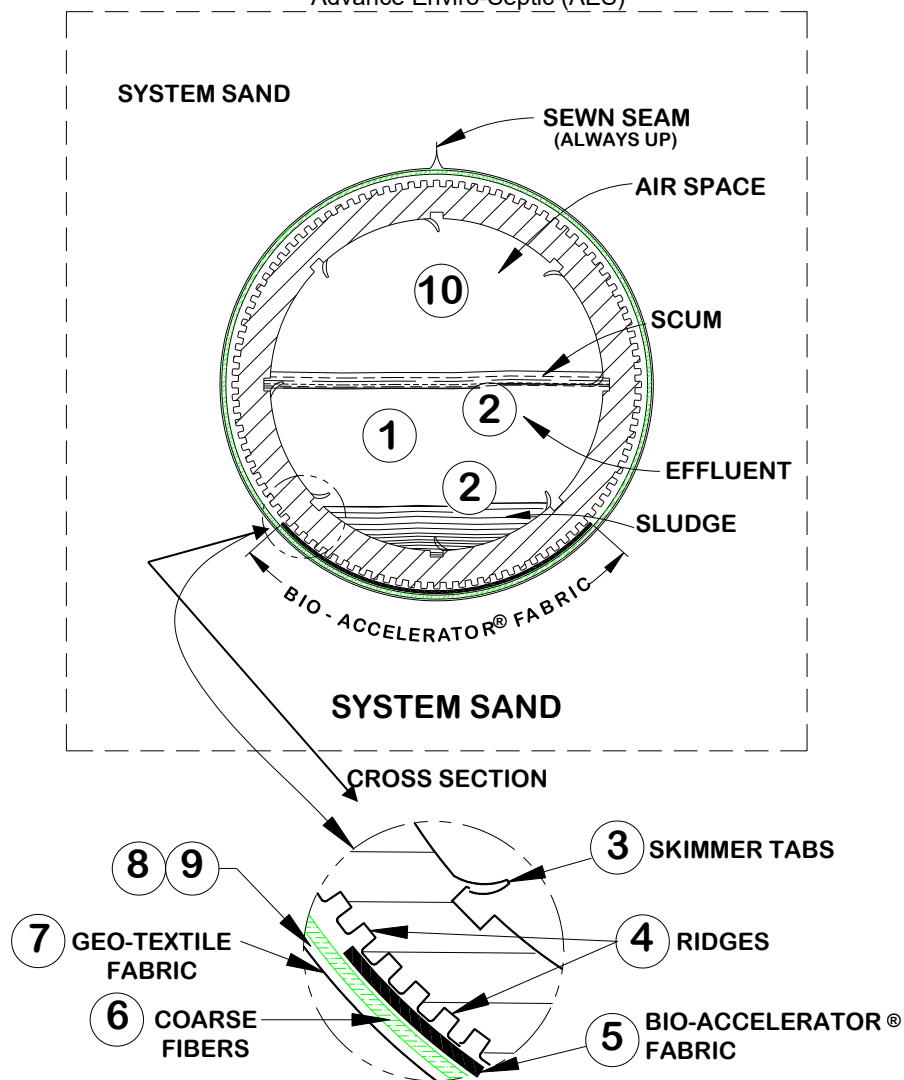

- Stage 1:** Warm effluent enters the pipe and is cooled to ground temperature.
- Stage 2:** Suspended solids separate from the cooled liquid effluent.
- Stage 3:** Skimmers further capture grease and suspended solids from the existing effluent.
- Stage 4:** Pipe ridges allow the effluent to flow uninterrupted around the circumference of the pipe and aid in cooling.
- Stage 5:** Bio-Accelerator fabric screens additional solids from the effluent, enhances and accelerates treatment, facilitates quick start-up after periods of non-use, provides additional surface area for bacterial growth, promotes even distribution, and further protects outer layers and the receiving surfaces so they remain permeable.
- Stage 6:** A mat of coarse, randomly-oriented fibers separates more suspended solids from the effluent.
- Stage 7:** Effluent passes into the geo-textile fabrics and grows a protected bacterial surface.
- Stage 8:** Sand wicks liquid from the geo-textile fabrics and enables air to transfer to the bacterial surface.
- Stage 9:** The fabrics and fibers provide a large bacterial surface to break down solids.
- Stage 10:** An ample air supply and fluctuating liquid levels increase bacterial efficiency.

3.0 AES System Components

3.1 Advanced Enviro-Septic Pipe

- a) Plastic pipe made with a significant percentage of recycled material
- b) 10 ft. sections (can be cut to any length)
- c) Ridged and perforated, with skimmer tabs on interior
- d) Supplied with Bio-Accelerator along bottom of the pipe (the sewn seam indicates "this side up").
- e) Surrounded by a mat of randomly oriented plastic fibers
- f) Wrapped in a non-woven geo-textile fabric stitched in place
- g) Exterior diameter of 12 in.
- h) Each 10 ft. section has a liquid holding capacity of approx. 58 gallons
- i) A 10 ft. length of pipe is flexible enough to bend up to 90°



3.2 Offset Adapter

An offset adapter is a plastic fitting 12 in. in diameter with a 4 in. hole designed to accept a 4 in. inlet pipe, raised connection or vent pipe. The hole is to be in the 12 o'clock position, 7 in. above bottom of the AES pipe. When assembling pipes into rows, note that the geo-textile fabrics are placed over the edges of the Offset Adapter and Couplings.



3.3 Coupling

A coupling is a plastic fitting used to create a connection between two pieces of pipe. Note that the couplings are wide enough to cover 1 or 2 pipe corrugations on each of the two pipe ends being joined. The couplings feature a snap-lock feature that requires no tools. When assembling pipes into rows, note that the geo-textile fabric does not go under couplings. Pull fabric back, install coupling, and then pull fabric over coupling. Also note, during installation in cold weather, couplings are easier to work with if stored in a heated location before use; such as a truck cab.



3.4 Raised Connection

A raised connection is a PVC Sewer & Drain pipe configuration which is used to connect pipe rows. Raised connections extend 2 in. to 4 in. into pipe and are installed on an angle (as shown below). All PVC joints should be glued.

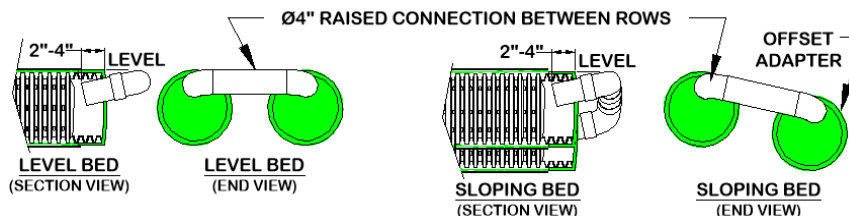

4.0 Introduction

4.1 Presby Environmental Standards

All AES systems must be designed and installed in compliance with the procedures and specifications described in this Manual and in the product's Indiana approval.

4.2 Indiana Rules

This manual is to be used in conjunction with Rule 410 IAC 6-8.3 for residential systems effective 5-9-14 and with Rule 410 IAC 6-10.1 for commercial systems effective 5-17-14.

4.3 Conflicts between Indiana Rules & Manual

In the event of contradictions between this Manual and Indiana State Department of Health (ISDH) regulations, the ISDH and Presby Environmental, Inc. (800-437-5298) must be contacted for technical assistance.

4.4 Certification Requirements

Any designers and installers who have not previously attended a Presby Environmental, Inc. "Certification Course" are required to obtain Presby Certification. Certification is obtained by attending a Certification Course presented by Presby Environmental, Inc. or its sanctioned representative. Certification can also be obtained by viewing tutorial videos on our website (high speed connection required) and then successfully passing a short assessment test,

which is also available over the internet. All professionals involved in the inspection, review or certification of AES Systems must also become Presby Certified.

4.5 Exceptions to Presby Requirements

To resolve any conflicts with or exceptions to any requirements in this Manual, the ISDH and Presby Environmental, Inc. must be contacted.

4.6 Technical Support

Presby Environmental, Inc. provides technical support to all individuals using our products. For questions about our products or the information contained in this Manual, or to register for a Certification Course, please contact us at 1-800-473-5298.

5.0 Design Criteria

This section presents the various design configurations of the AES system. The system configuration to be used is determined by characteristics of the receiving soils, vertical distance to the SHWT or restrictive feature, other characteristics specific to the particular site and the design daily flow.

5.1 Advanced Enviro-Septic Sizing

AES systems use the bed sizing tables, pipe and installation requirements noted in this manual.

5.2 Converging Flows Restriction

Systems must not be located where surface or ground waters will converge, causing surface water flow to become concentrated or restricted within the soil absorption field.

5.3 Distribution Box (D-box)

A D-box is used to divide flow to more than one portion of the bed. Distribution boxes are required for all Combination Distribution and Pump Systems, but NOT for Basic Serial Systems. There is no minimum separation distance requirement from a D-box to the AES pipe.

5.4 Distribution Box Manifold

A manifolded distribution box joins several outlets to help divide flow more accurately. Dividing flow to multiple beds is a common use of manifolded D-boxes. All outlets delivering effluent to the field must have a flow equalizer. Do not place an equalizer on vent outlets.

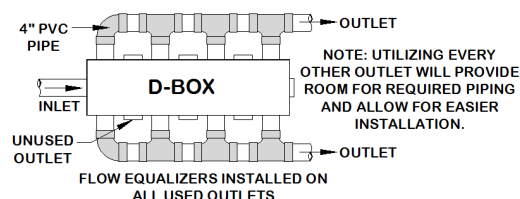

5.5 Flow Equalizers Required

All distribution boxes used to divide effluent flow require flow equalizers in outlets feeding AES pipe. Equalizers are designed to help compensate for an out of level distribution box, which is likely to occur over time, and maintain a balanced flow to each distribution box outlet leading to the field. Flow equalizers are limited to a maximum of 15 GPM per equalizer and are never placed on D-box outlets used for venting.

5.6 End-to-End Preferred Over Side-to-Side

If site conditions permit, end-to-end multiple bed configurations are preferable to side-to-side configurations.

5.7 Row Elevations for Sloping Sites

Elevations must be provided on the construction drawing for each AES row in the bed system.

5.8 Row Orientation

Rows must be laid level to within +/- 1/2 in. and must be placed along the contour of the site. The minimum center-to-center spacing is 1.5 ft. The center-to-center spacing may be larger, but not less than the minimum requirement. The designer must clearly state the row elevations on the system's construction drawing(s).

5.9 Row Requirement

All beds must have at least 2 rows with a minimum row spacing of 1.5 ft. center-to-center. For level beds the rows are centered in the middle of the basal area and for sloping beds the rows are grouped at the high side of the basal area. For additional information regarding row placement, see para. 6.2, pg. 5.

5.10 Maximum and Minimum Row Lengths

To maintain efficient effluent cycling within the AES pipe, the maximum row length is 100 ft. (not including System Sand) and the minimum row length is 30 ft. For repair or replacement systems, the "best judgment" clause of 410 IAC 6-8.3-53(i) must be followed. Fields are to be constructed as long and narrow as the site permits.

5.11 Pump System Requirements

- a) The use of pressure distribution within an AES system is not permitted.
- b) Pump systems to gain elevation are allowed.
- c) Systems incorporating pumps to gain elevation must use differential venting and velocity reduction to control liquid flow.

Reference: See Pump System Requirements, para. 19.0, pg. 18.

5.12 Septic Tank and Distribution Box Elevations

- a) The outlet of a distribution box must be set at least 2-in. above the highest inlet of the AES row.
- b) If a distribution box is not used and the septic tank is connected directly to a Basic Serial system (see para. 7.0 on pg. 8); the outlet of the septic tank must be set at least 2-in. above the highest inlet of the AES row, but never sloped less than 1% (approximately 1/8 in. per foot.)

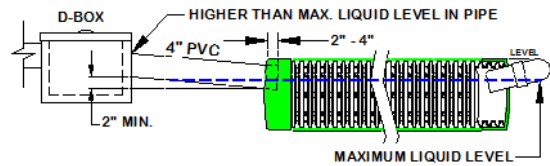

5.13 System Side Slope Tapers

If a bed extends above grade, the IN DOT 23 sand and the cover soils on the system must have side slope tapers until it meets the original grade. Side slope tapering is to be no steeper than 3:1; steeper side slopes require ISDH approval. The side slope taper begins 3 ft. from the AES pipe, measured parallel to the system slope - if any - (see illustrations in para. 6.12, pg. 7).

5.14 Ten Foot Increments Work Best

It is easier if row lengths are designed in 10 ft. increments since AES pipe comes in 10 ft. sections. However, if necessary, the pipe is easily cut to any length to meet site constraints. Using 5 ft. increments minimizes waste of pipe material.

5.15 Velocity Reduction

Reduce the velocity of liquid entering AES pipe to eliminate turbulence. A distribution box which includes a Rule-compliant baffle, 90° bend with weep hole, or inlet tee may be adequate for velocity reduction in most systems. When pumping to gain elevation, pump to a large distribution box or equivalent (like a small septic tank that feeds the D-box) with proper baffles or tee at the end of the delivery line.

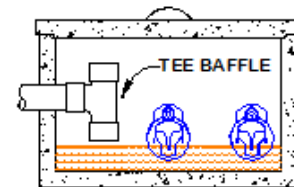

5.16 Venting Requirements

Venting is required for all AES Systems. See Venting Requirements, para. 20.0, pg. 19.

6.0 Indiana State Specific Information

6.1 Infiltrative Surface (Bed Bottom)

The infiltrative surface is defined as the bottom of the System Sand (IN DOT 23 sand) bed. Vertical separation distances are measured from the infiltrative surface.

6.2 Sloping Sites and Sloping Systems

Bed Elevation	Bed Configuration		Maximum Site Slope
	Level	Sloping	
Subsurface (Infiltrative Surface ≥ 4" Below Original Grade)	≤ ½% Site Slope	> ½% Site Slope	15%
Elevated (Infiltrative Surface < 4" Below Original Grade)	≤ ½% Site Slope	> ½% Site Slope	6%

Notes:

1. For sloping systems, the rows are grouped at the high side of the System Sand bed (see illustrations in para. 7.0, pg. 8 and para. 8.0, pg. 9).
2. The percentage of system slope in all drawings (in this manual) refers to the slope of the AES system and not the existing terrain unless otherwise noted. Systems should be constructed to follow the original site grade when possible.
3. The slope of the site and/or the system may contain more than one slope provided the maximum allowed slope is not exceeded (see para. 13.1, pg. 12).
4. Maximum Site Slope specification is dictated by the Rule.

6.3 Design Daily Flow

Design daily flow is calculated in accordance with Indiana rules. For daily design flows of less than two bedrooms, contact Presby Environmental for design criteria and written authorization.

6.4 Subsurface (In-Ground) System

- The infiltrative surface must be a minimum of 4 in. below the original grade.
- Subsurface systems must have at least 6 in. of System Sand (IN DOT 23 sand) below all AES pipes.
- Subsurface systems are allowed on slopes up to 15%
- Subsurface systems are designed along the contour while adhering to minimum separation distances to restrictive features.
- When the System Sand (IN DOT 23 sand) or the cover material extends above original grade, the IN DOT 23 sand and the soil material covering the system must have side slopes tapering at a maximum of 3:1.

6.5 Elevated Bed Systems

- To qualify as an elevated bed, the infiltrative surface must be less than 4 in. below the original grade.
- Elevated systems must have at least 12 in. of System Sand (IN DOT 23 sand) below all AES pipes (see para. 6.6, below)
- Cover material extensions (materials extending beyond the edges of the AES pipe perimeter) are required before beginning the slope tapers (see para. 6.6 below).
- Elevated systems are allowed on slopes up to 6%.
- While beds elevated above original grade are required to follow the contours of the original grade, the spacing and slope of the pipes shall remain consistent from end to end.

6.6 Section Views of Subsurface and Elevated Systems

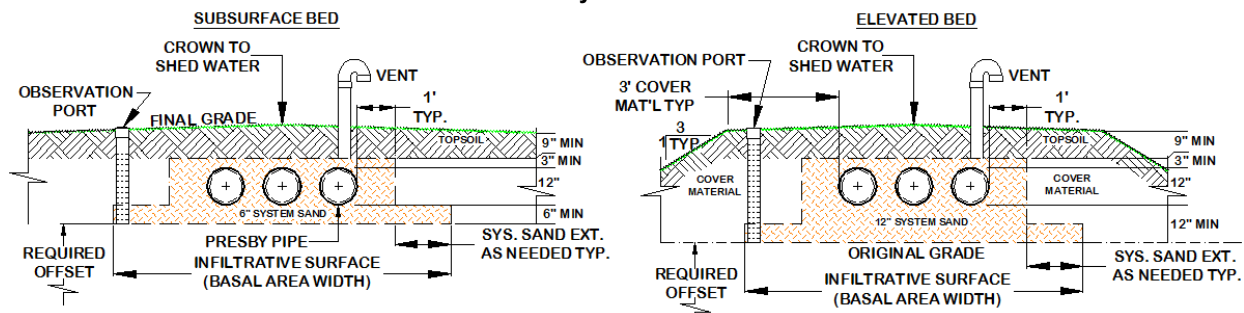

6.7 AES Pipe Substitutions

Substitutions to the AES Pipe shown on the approved septic system design is not allowed without the written approval of the health department that approved the design and the system's designer. This includes substituting another manufacturer's pipe or even other models of Presby pipe. For example: if AES pipe was specified by the approved plan, no other competing product can be substituted without written approval and an amended design plan showing the substitution. AES may be used as a substitute for Enviro-Septic (ES) or Simple-Septic (SS) products that have been specified by the approved plan with an amendment.

6.8 System Sand Requirements for All Beds

It is critical to the proper functioning of the system that the proper amount and type of System Sand be installed. System Sand must be clean, granular sand, free of organic matter and must adhere to Indiana DOT 23 sand requirements. Material passing the #200 sieve must be verified by washing the sample. In this manual, the terms System Sand and Indiana DOT 23 sand are used interchangeably. The Presby Spec-Check® is a device created to help determine the suitability of material for use as System Sand without the need for an expensive lab test. Go to www.PresbyEnvironmental.com for more details.

6.9 System Sand Bed Height Dimensions

The height of an AES system measures 21-inches minimum for In-Ground Systems and 27-inches minimum for Elevated Systems (not including cover material – see illustrations in para. 6.6 above):

- 6-inches minimum of System Sand below the AES pipe for In-Ground Systems;
- 12-inches minimum of System Sand below the AES pipe for Elevated Systems;
- 12-inches diameter of the AES pipe; and
- 3-inches minimum of System Sand above the AES pipe.

6.10 System Sand Extension

Systems that slope more than 10% require a 3 ft. System Sand extension on the down slope side of the System Sand bed (see illustration in para. 6.12 below). The System Sand Extension area (any part of the System Sand bed that is more than 1 ft. away from the AES pipes) is required to be a minimum of 6 in. deep. The System Sand extension should not be confused with the “cover material extension,” which refers to the material used to cover the field.

6.11 Sand Fill

Indiana DOT 23 sand is to be used as “sand fill” whenever sand fill is required.

6.12 Cover Material Extensions and Side Slope Tapers

- A 3 ft. cover material extension (measured from the AES pipe) is required on each side of any bed that extends above the original grade, which has a system slope of 10% or less, before the side slope tapering can begin.
- If the system slope is greater than 10%, the soil cover material extension must be increased to 5 ft., but only on the down slope side of the field (the remaining three sides only require a 3 ft. cover material extension).
- Side slope tapers are to be a minimum of 3 horizontal feet for each 1 foot of vertical drop. Refer to Site Preparation Prior to Excavation, para. 22.3, pg. 22 for erosion control and surface water diversion procedures. Do not confuse the “cover material extension” with a System Sand extension. The cover material extension refers to the material used to cover a field.
- Illustrations of beds that extend above the original grade:

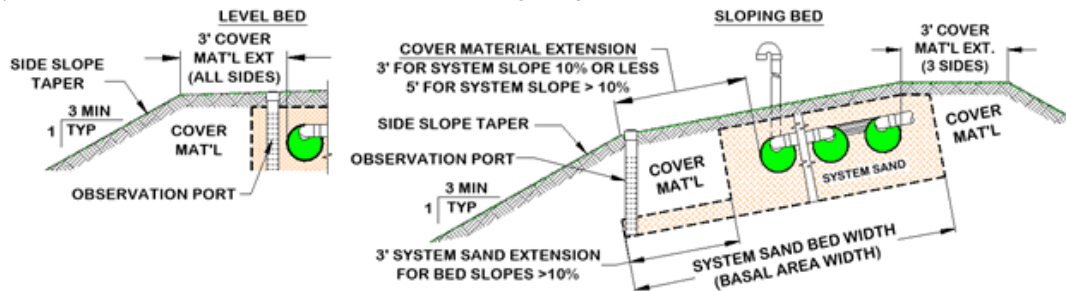

6.13 Topsoil

Suitable earth cover, similar to the naturally occurring soil at the site and capable of sustaining plant growth, is required as the uppermost layer over the entire system (including cover material extensions, side slope extensions and System Sand extensions). The topsoil layer should be a minimum of 9 inches deep and should be immediately seeded or mulched in order to prevent erosion.

6.14 Observation Port

All beds require at least one 4 in. diameter perforated Observation Port wrapped with geo-textile fabric and installed at the bottom of the infiltrative surface (bed bottom). For level beds, the port is to be located at the outermost edge of the tall portion of the System Sand or System Sand extension (if present). For sloping beds, locate the port at the lowest elevation of the System Sand extension. The port must extend to final grade for easy access and have a threaded cap (see illustrations in para. 6.12 above).

6.15 Filters, Alarms & Baffles

- Effluent Filters are not required when using an AES system.
- If a filter is used, they **must** be maintained on at least an annual basis. Follow manufacturer’s instructions regarding required inspections, cleaning and maintenance of the effluent filter. Effluent Filters must allow the free passage of air to ensure the proper functioning of the system. A blocked filter in any on-site septic system could interfere with venting, causing the system to convert to an anaerobic state.
- All pump systems must have a high-water alarm float or sensor installed inside the pump chamber.
- All septic tanks must be equipped with baffles to prevent excess solids from entering the system.
- Charcoal filters in vent stacks (for odor control) are not recommended by PEI. They can block air flow and potentially shorten system life. Contact PEI for recommendations to correct odor problems.

6.16 Field Renovation (Set-Aside Area)

In the event of system malfunction, contact PEI for technical assistance prior to attempting Rejuvenation procedures or system replacement. Refer to System Bacteria Rejuvenation and Expansion, para. 23.0, pg. 25. In the unlikely event that an AES system needs to be replaced ...

- The system can be repaired and left in the same location if an alternate site is not available and if allowed by state and local authorities.

- b) Prior to initiating the repair system construction, the failed system components and any unsuitable System Sand must be removed, except that the original infiltrative surface shall not be disturbed other than by hand raking.
- c) Disposal of hazardous materials to be in accordance with state and local requirements.
- d) Contact the appropriate local or state department for necessary permits.

6.17 Pressure Distribution

The use of pressure distribution lines in AES systems is prohibited. Pumps may be utilized when necessary only to gain elevation and to feed a distribution box which then distributes effluent by gravity to the field.

6.18 Separation Distances Measured to System Sand

Horizontal and vertical setbacks to restrictive features and the seasonal high-water table (SHWT) are measured from the outermost edge of the System Sand (this includes any System Sand extensions – if present).

6.19 Barrier Materials over System

No geo-textile barrier materials are to be placed between the System Sand and soil cover material; such materials may cut off necessary oxygen supply to the system.

6.20 Restrictive Layer

Any horizon that has an IN-SLR less than 0.25 GPD/ft² or greater than 1.20 GPD/ft² are considered restrictive layers.

6.21 Vertical Separation Distances

Required minimum vertical separation distance to the infiltrative surface:

Bed Elevation	Distance to Restrictive Feature	Distance to SHWT
Subsurface (Infiltrative surface ≥4 in. below original grade)	24 in. for daily flows < 3 bedrooms (450 GPD) 30 in. for daily flows of 3 bedrooms (450 GPD) + (note: individual bed loading used to determine separation)	24 in. (may be lowered to that level with the use of subsurface drains)
Elevated (Infiltrative surface <4 in. below original grade)	20 in. regardless of daily flow	20 in. (may be lowered to that level with the use of subsurface drains)

6.22 Dispersal Area Requirements

Dispersal area requirements for residential systems per 410 IAC 6-8.3 and commercial systems per 410 IAC 6-10.1.

6.23 Basic Serial Systems and Flow Equalizers

Flow Equalizers are only required when dividing flow (see para. 5.5, pg. 4). Basic Serial Systems do not divide flow (even when pumping to a D-box for a Basic Serial System) and therefore do not require a Flow Equalizer.

7.0 Basic Serial Distribution

Basic Serial distribution may be used for single beds of 750 GPD or less. Basic Serial distribution systems are quick to develop a strong biomat in the first row and provide a longer flow route and improved effluent treatment.

- a) Basic Serial distribution incorporates rows in serial distribution in a single bed.
- b) AES rows are connected at the ends with raised connections, using offset adapters and PVC pipe.
- c) Maximum length of any row is 100 ft.
- d) Beds must contain a minimum of two rows.
- e) Illustration of a level, four row Basic Serial system:

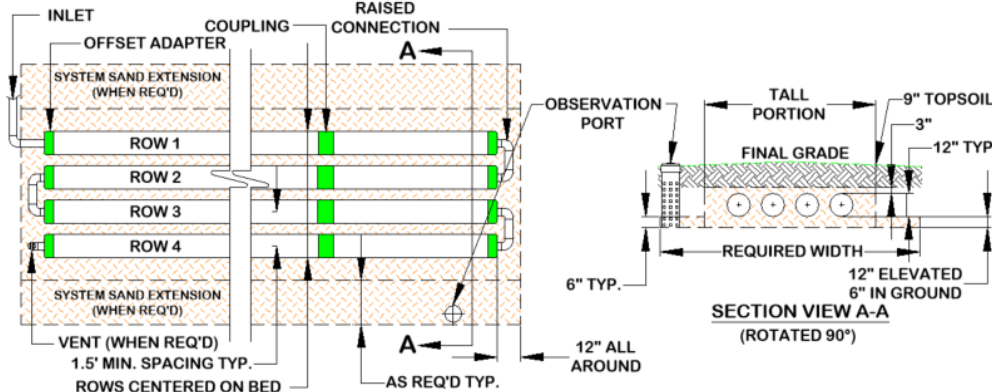

f) Illustration of sloping, four row Basic Serial system:

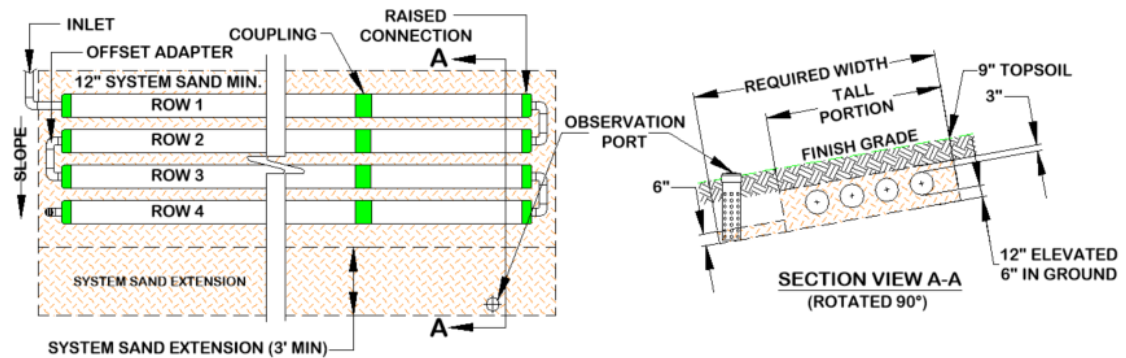

7.1 Parallel Distribution

All rows in this configuration must be the same length.

- Effluent flow is divided to each pipe row using a D-box equipped with flow equalizers.
- Use a Vent Manifold to connect the ends of all rows to ensure adequate air flow. Manifold to be sloped toward the AES pipes (see para. 20.7, pg. 21).
- Maximum row length is 100 ft.
- Place the D-box on level, firmly compacted soil, sand, pea gravel base or concrete pad.
- All rows must be laid level end-to-end.
- A 2-in. min. drop is required between the D-box outlet and the AES pipe inlets.
- Parallel distribution illustration for level system:

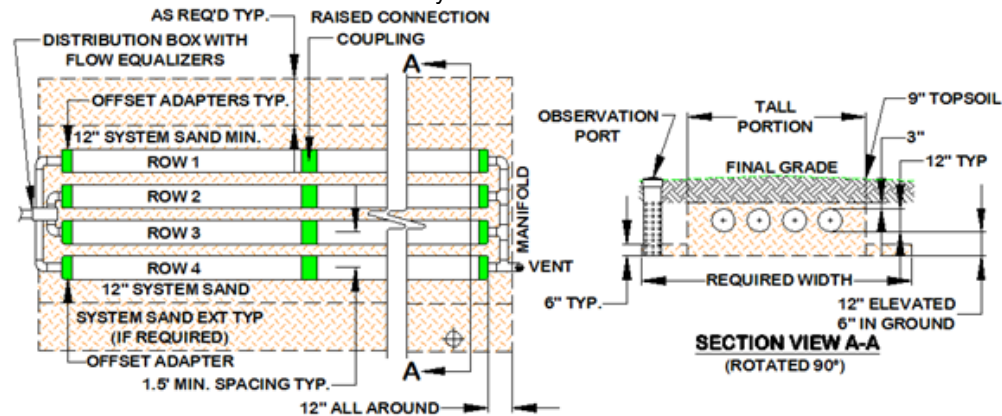

h) Parallel distribution illustration for sloping system:

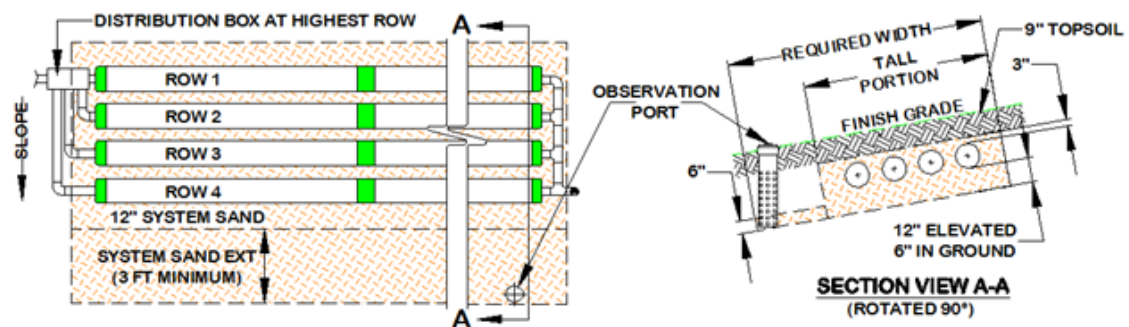

8.0 Combination Serial Distribution

Combination Serial distribution is required for systems with design daily flows greater than 750 GPD. Combination Serial distribution is quick to develop a strong biomat in the first row of each section, providing improved effluent treatment.

- Combination Serial distribution consists of two or more serial sections installed in a single bed.
- Effluent flow is divided to each serial section using a D-box equipped with flow equalizers.

- c) Each serial section consists of a series of rows connected at the ends with raised connections, using Offset Adapters and PVC pipe.
- d) Maximum length of any row is 100 ft.
- e) Serial Section loading limit is 750 GPD. Ex: $900 \text{ GPD} \div 750 = 1.2$, round up to two
- f) There is no limit on the number of Combination Serial Sections within a bed.
- g) A 2-in. min. drop is required between the D-box outlet and the AES pipe inlets.
- h) Level Combination Serial system illustration (two serial sections shown):

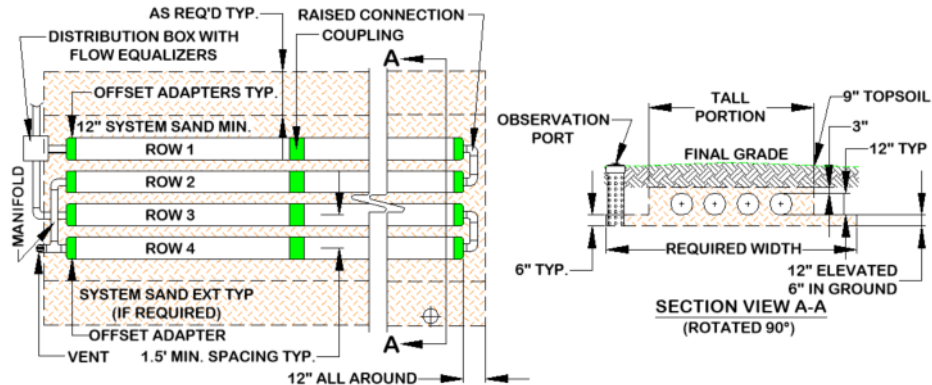

- i) Sloping Combination Serial system illustration (two serial sections shown):

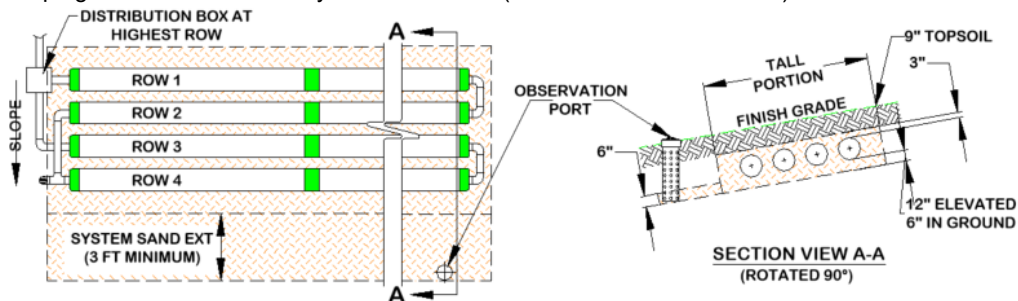

Note: manifold runs over the top of inlets (as shown in illustrations above) when on same side as D-box.

8.1 Section Length Requirement

- a) Each serial section must have the same minimum linear feet of pipe.
- b) The minimum linear feet of pipe per section is determined by dividing the total linear feet required in the system by the number of sections required. A section may exceed the minimum linear length.
- c) Rows within a section may vary in length to accommodate site constraints (see para. 13.0, pg. 12).

9.0 Butterfly Configuration

A Butterfly Configuration system is considered a single bed.

- a) Maximum length of any row is 100 ft.
- b) Serial Section loading limit is 750 GPD.
- c) Beds can contain any number of serial sections.
- d) Example of how to calculate the number of serial sections required: $1,500 \text{ GPD loading} (1,500 \div 750 = 2 \text{ serial sections})$
- e) Illustration of a typical Butterfly Configuration:

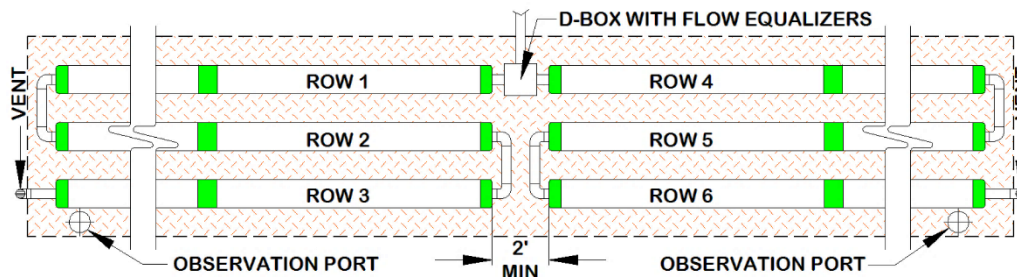

Note: number of rows will vary with row length.

10.0 Curved Beds

Curved configurations work well around structures, setbacks, and slopes. Multiple curves can be used within a system to accommodate various contours of the site.

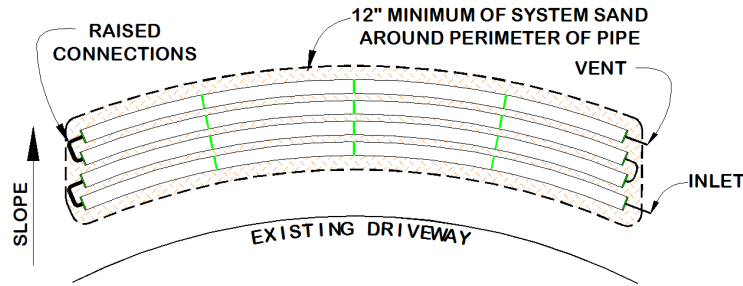

11.0 90° Beds

Angled configurations generally have one or more specific bends, but the rows and bed are to be oriented along the contours of the site as illustrated below. Rows are angled by bending pipes (first drawing, below) or through the use of offset adapters (second drawing, to right).

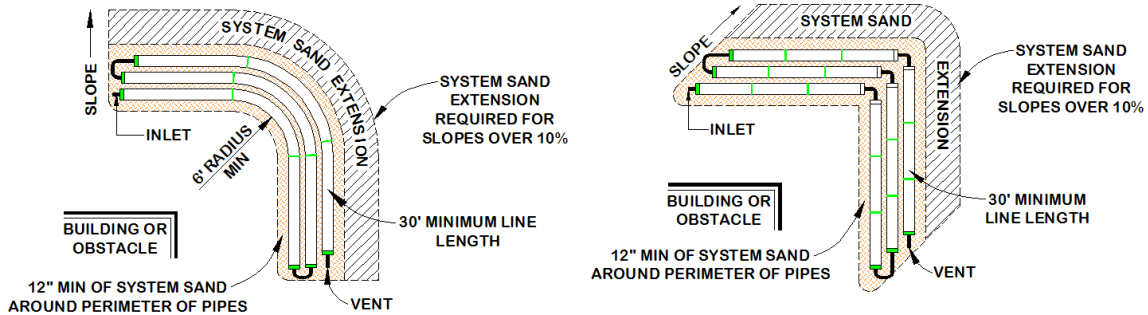

Notes: A 10 ft. length of AES pipe may be bent up to 90°. The angled system shown to the right requires 30 ft. min. row lengths.

12.0 Multiple Bed Distribution

Multiple Bed distribution incorporates two or more beds, each bed proportionately sized for the effluent flow into it. Each bed may be constructed as Basic Serial, Combination Serial, or Parallel distribution. Multiple beds must be oriented along the contour of the site or along the slope of the site. End-to-end configurations are preferred to side-to-side configurations. When using multiple beds, the pipe requirement (from Table A) and the required system sand bed area (from Table B) must be divided proportionally. For example: using AES pipe, the treatment field requirements for a (4)-bedroom residence on very fine sand soils are: 280 ft. of AES pipe min. (Table A – 4 bedrooms x 70 ft.), 800 sq. ft. of System Sand Bed Area min. (Table B – 600 GPD, 0.50 IN-SLR → 0.75 PR-SLR requires 800 sq. ft.). If this is divided into two beds, each field must have at least 140 ft. of AES pipe and 400 sq. ft. of SSBA.

12.1 Side-to-Side Configuration (bed separation distance per Indiana rules):

In Side-to-Side configuration, one bed is placed beside another or one bed is placed down slope of another. When subsurface drainage is required, a segment drain placed between the beds is required. When subsurface drainage is not required or used, the beds shall be provided with a dispersal area (outside the system sand bed area) as required in 410 IAC 6-8.3-58 or 410 IAC 6-10.1-62, whichever is applicable.

Illustration of a two bed Side-to-Side layout:

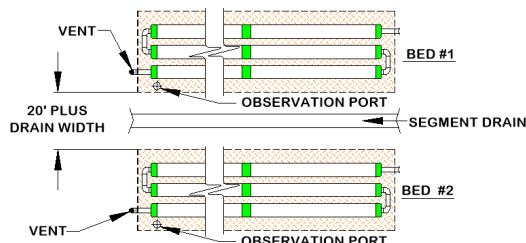

12.2 End-to-End Two Bed System

Bed separation for End-to-End bed systems is 2 ft. minimum measured from the edge of each sand bed.

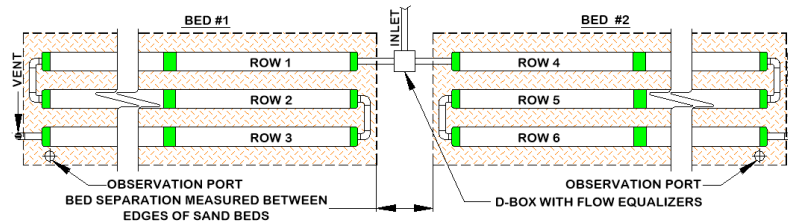

12.3 Bed Separation Distances

Separation distances between beds placed end-to-end are measured from the end of the AES pipe, while the separation distance for beds placed side-to-side is measured from the outermost edge of the System Sand or System Sand extension if present.

13.0 Non-Conventional System Configurations

Non-conventional system configurations may have irregular shapes to accommodate site constraints. If the site will accommodate a conventional AES system configuration, a non-conventional AES system may not be used. Non-conventional configurations are limited to soils with an IN-SLR of 0.6 GPD/ft² or faster.

13.1 Multiple Slopes within a Bed

A sloping bed may be designed to incorporate more than one slope. This is often done to match the existing terrain. The maximum site slope for subsurface or elevated beds cannot be exceeded in any area, see para 6.2, pg. 5 for maximum site slopes allowed. System Sand Extensions are required when any portion of the bed slopes greater than 10%. Refer to para. 6.10, pg.7 for more information on System Sand Extensions. See illustration below:

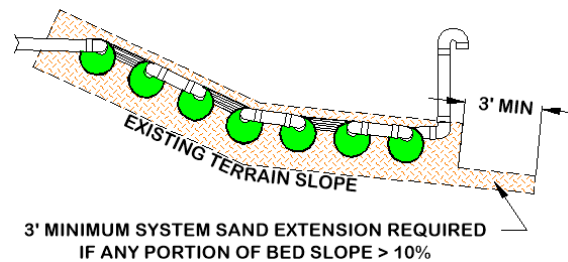

13.2 Non-Conventional Configurations

Below are illustrations of beds with varying row lengths. The first row of a trapezoidal systems must be the longest row. For multi-section beds, each serial section must contain the minimum amount of AES pipe required per section (see para. 8.1, pg. 10 for details).

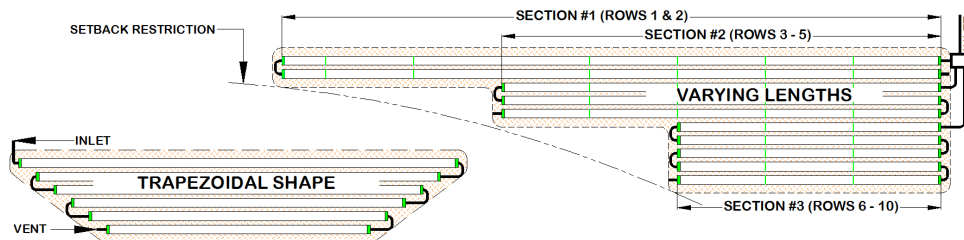

14.0 Subsurface Drainage, Surface Diversions and Segment Drains

Subsurface drainage and surface diversions shall be required when required in 410 IAC 6-8.3-59 or 410 IAC 6-10.1-63, whichever is applicable. Subsurface drains and surface diversions shall be designed and installed in accordance with those sections of the state rules.

A segment drain is a subsurface drainage system that is constructed between two beds in the same on-site sewage system. The purpose of the segment drain is to intercept and divert subsurface water away from the downslope soil absorption field. Segment drains require a 10 ft. separation between the drain and each field (see illustration para. 12.1, pg. 11).

15.0 Table A – Pipe Required

Use Table A below to determine the minimum quantity of pipe required. AES pipe may be used as substitution for ES or SS following updating permit request with local regulating authorities and the system’s designer (see para. 6.7, pg. 6 for more information on product substitutions).

Table A –Pipe Required

Pipe Model	Quantity per bedroom (ft. minimum)
Advanced Enviro-Septic®	70

16.0 Table B – System Sand Bed Area (SSBA) Required

Find the Indiana soil loading rate (IN-SLR) in Table B below to determine the System Sand Bed Area.

Table B - System Sand Bed Area (SSBA) required, minimum (ft²)

Indiana Soil Loading Rate (IN-SLR) Class	Presby Soil Loading Rate (PR-SLR) (GPD/ft²)	Bedrooms / Gallons per Day								
		2	3	4	5	6	7	8	9	10
1.20	1.79	168	252	336	419	503	587	671	755	838
0.75	1.12	268	402	536	670	804	938	1,072	1,206	1,340
0.60	0.90	334	500	667	834	1,000	1,167	1,334	1,500	1,667
0.50	0.75	400	600	800	1,000	1,200	1,400	1,600	1,800	2,000
0.30	0.45	667	1,000	1,334	1,667	2,000	2,334	2,667	3,000	3,334
0.25	0.37	811	1,217	1,622	2,028	2,433	2,838	3,244	3,649	4,055

System Sand Bed Area minimum (ft²)

Notes: SSBA may be divided into multiple beds provided the total SSBA is equal to or greater than the value shown above. The SSBA may only include the system sand one foot beyond the ends of the pipe rows.

Indiana 410 IAC 6-8 Tables IV & V – Soil Loading Rates (GPD/ft²)

Structure Texture	Single Grain	Granular	Strong: Angular, Sub-Angular Blocky, Prismatic	Moderate: Angular, Sub-Angular Blocky, Prismatic	Weak: Angular, Sub-Angular Blocky, Prismatic; Platy ¹	Fragic Characteristics: Very Coarse Prismatic	Structureless, Massive, Friable, Very Friable	Structureless Massive, Compact, Firm, Very Firm; Platy ²
Gravel, Coarse Sand	>1.2	N/A	N/A	N/A	N/A	N/A	N/A	N/A
Loamy Coarse Sand, Medium Sand	1.20	1.20	N/A	N/A	1.20	N/A	N/A	N/A
Fine Sand, Loamy Sand, Loamy Fine Sand	0.60 / 0.75	0.60	N/A	0.60 / 0.75	0.60 / 0.75	N/A	0.60 / 0.75	N/A
Very Fine Sand, Loamy Very Fine Sand	0.50	0.50	N/A	0.50 / 0.75	0.50 / 0.60	N/A	0.50 / 0.60	N/A
Sandy Loam, Coarse Sandy Loam	N/A	0.60 / 0.75	N/A	0.60	0.60	0.00	0.60	0.00
Fine Sandy Loam, Very Fine Sandy Loam	N/A	0.60 / 0.75	N/A	0.60	0.60	0.00	0.60	0.00
Loam	N/A	0.50 / 0.75	0.50 / 0.75	0.50	0.50	0.00	0.50	0.00
Silt Loam, Silt	N/A	0.50 / 0.75	0.50 / 0.75	0.50	0.50 / 0.30	0.00	0.50 / 0.30	0.00
Sandy Clay Loam	N/A	0.50 / 0.60	0.50 / 0.60	0.50	0.50 / 0.30	0.00	0.50 / 0.30	0.00
Silty Clay Loam, Clay Loam, Sandy Clay	N/A	0.25 / 0.60	0.25 / 0.60	0.25	0.25 / 0.30	0.00	0.25	0.00
Silty Clay, Clay	N/A	0.25 / 0.60	0.25 / 0.50	0.25	0.25 / 0.30	N/A	0.25	0.00
Organic Soil Material	N/A	N/A	N/A	N/A	N/A	N/A	0.00	N/A
Limnic Soil Materials	N/A	N/A	N/A	N/A	N/A	N/A	N/A	0.00
Bedrock	N/A	N/A	N/A	N/A	N/A	N/A	N/A	N/A

Upper left of diagonally split cells = above ground systems, Lower right value in split cells = subsurface systems.

¹ Naturally occurring platy structure.

² Platy structure caused by compaction has a soil loading rate of 0.00 GPD/ft² unless broken up by methods approved by ISDH.

17.0 Table C: System Pipe Row Length and Pipe Layout Width (PLW)

		Total Linear Feet of AES Pipe													
Row Length Ft.	30	60	90	120	150	180	210	240	270	300	330	360	390	420	450
	35	70	105	140	175	210	245	280	315	350	385	420	455	490	525
	40	80	120	160	200	240	280	320	360	400	440	480	520	560	600
	45	90	135	180	225	270	315	360	405	450	495	540	585	630	675
	50	100	150	200	250	300	350	400	450	500	550	600	650	700	750
	55	110	165	220	275	330	385	440	495	550	605	660	715	770	825
	60	120	180	240	300	360	420	480	540	600	660	720	780	840	900
	65	130	190	260	325	390	455	520	585	650	715	780	845	910	975
	70	140	210	280	350	420	490	560	630	700	770	840	910	980	1050
	75	150	225	300	375	450	525	600	675	750	825	900	975	1050	1125
	80	160	240	320	400	480	560	640	720	800	880	960	1040	1120	1200
	85	170	255	340	425	510	595	680	765	850	935	1020	1105	1190	1275
90	180	270	360	450	540	630	720	810	900	990	1080	1170	1260	1350	
95	190	285	380	475	570	665	760	855	950	1045	1140	1235	1330	1425	
100	200	300	400	500	600	700	800	900	1000	1100	1200	1300	1400	1500	
# Rows	2	3	4	5	6	7	8	9	10	11	12	13	14	15	
1.5 ft. Spacing	2.50	4.00	5.50	7.00	8.50	10.00	11.50	13.00	14.50	16.00	17.50	19.00	20.50	22.00	

Pipe Layout Width (PLW) in feet (outermost width of rows)

18.0 Design Procedure (Single Bed)

Step #1: Find the minimum quantity of pipe required from Table A and multiply by the number of bedrooms.

Step #2: From Table B, find the minimum System Sand Bed Area (SSBA) using the IN-SLR. The sand bed area is also known as the Basal Area.

Step #3: Calculate the number of serial sections required (skip if using parallel configuration). The serial sections required = design daily flow ÷ 750 GPD/section (always round up to nearest whole number).

Step #4: Select as long a row length as the site will accommodate and calculate the number of rows required by dividing the pipe required from Step #1 by your selected row length. The number of rows must be evenly divisible by the number of serial sections required. Increase the number of rows if needed.

Step #5: Using Table C, find the Pipe Layout Width (PLW) for the row length and number of rows being used.

Step #6: Calculate the minimum System Sand Bed Width (SSBW)

- a) **Beds sloping 10% or less:** Divide the SSBA from Step #2 by the (row length + 2 ft.). If this is greater than (PLW + 2 ft.), there will be a System Sand extension(s). If the bed is level: the rows are centered in the middle of the basal area. If the bed is sloping: the rows are grouped at the top of the basal area.
- b) **Beds sloping over 10%:** Beds sloping over 10% require a minimum 3 ft. system sand extension (4 ft. when measured from the edge of the pipe) and placed entirely on the down slope side of the pipes (see illustration below). Divide the SSBA from Step #2 by the (row length + 2 ft.). If this is greater than or equal to (PLW + 5 ft.) no increase to the sand bed width is needed otherwise the minimum System Sand Bed Width = (PLW + 5 ft.). The System Sand extension is placed entirely on the down slope side of the bed and = System Sand bed width just calculated – (PLW + 2 ft.).

Illustration of System Sand beds sloping over 10% (observation port not shown):

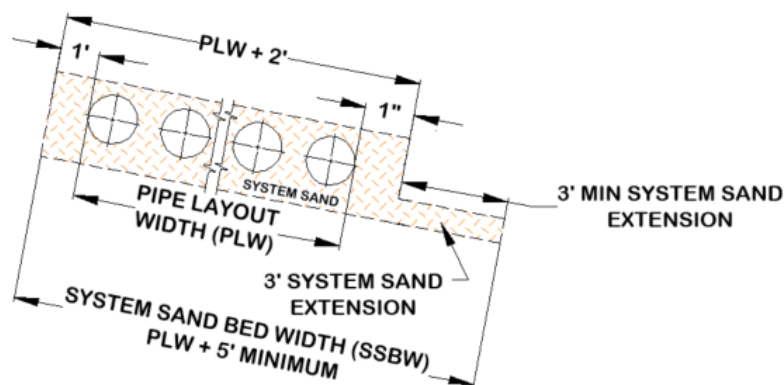

18.1 Design Example #1: Single Family Residence

Design criteria = (3) bedrooms, 450 GPD, IN-SLR = 0.75 GPD/sq. ft., PR-SLR = 1.12 GPD/sq. ft., level site, subsurface bed, Basic Serial Distribution, site constraint will not allow row length greater than 30 ft.

Step #1: Pipe required per bedroom for AES from Table A = 70 ft., 70 ft. x 3 bedrooms = 210 ft. pipe minimum

Step #2: Minimum SSBA (Basal Area) from Table B = 402 sq. ft. (450 GPD ÷ 1.12 GPD/sq. ft.)

Step #3: Number of Serial Section required = 450 GPD ÷ 750 = 0.6 (rounding up to one = basic serial layout)

Step #4: Choosing a row length of 30 ft. provides 7 rows in this bed (210 ft. ÷ 30 ft.)

Step #5: Table C shows a PLW of 10 ft. for a row length of 30 ft., row spacing of 1.5 ft. and the 210 ft. of pipe requirement.

Step #6: a) The minimum SSBW is $402 \text{ ft}^2 \div 32 \text{ ft. (row length + 2')} = 12.57 \text{ ft.}$ (use 13 ft. for ease of construction), which is greater than the PLW of 10 ft. + 2 ft. = 12 ft., System Sand extensions are needed. The System Sand extensions are = $[13 \text{ ft.} - (10 \text{ ft. PLW} + 2 \text{ ft.})] \div 2 = 0.5 \text{ ft.}$ each. Basal Area provide by this bed = $32 \text{ ft.} \times 13 \text{ ft.} = 416 \text{ ft}^2$. (b) this step isn't required because our bed is being constructed on a level site.

Illustration of example #1 system (not to scale):

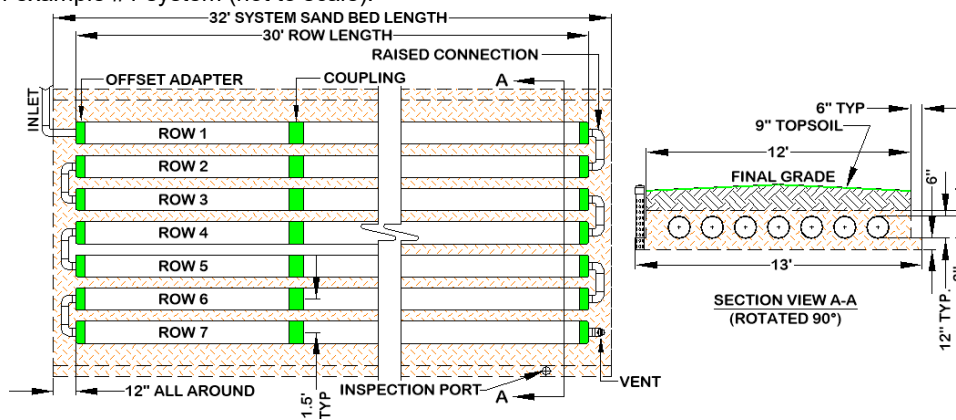

18.2 Design Example #2: Single Family Residence

Design criteria: (4) bedrooms, IN-SLR = 1.2 GPD/ft² (loamy coarse sand), PR-SLR 1.79 GPD/sq. ft., subsurface, sloping 11%, use basic serial distribution

Step #1: Pipe required from Table A = 4 x 70 ft. = 280 ft. minimum

Step #2: Minimum SSBA from Table B = 336 ft² (600 GPD ÷ 1.79 GPD/sq. ft.)

Step #3: Serial sections required = 600 GPD ÷ 750 GPD/section = 0.8 → 1-section = basic serial system

Step #4: Choosing a row length of 70 ft. provides 4 rows in this bed (280 ft. ÷ 70 ft. = 4).

Step #5: Table C shows a PLW of 5.5 ft. for a row length of 70 ft., row spacing of 1.5 ft. and the 280 ft. of pipe requirement.

Step #6: a) bed slopes > 10% use next step.

b) Minimum SSBW = $336 \text{ ft}^2 \div 72 \text{ ft. (row length + 2')} = 4.7 \text{ ft.}$, which is less than the 10.5 ft. (PLW of 5.5 ft. + 5 ft.), so the minimum System Sand Bed Width = (5.5 ft. PLW + 5 ft.) = 10.5 ft. The System Sand extension must be placed entirely on the down slope edge of the sand bed because this bed is sloping over 10%. Because this bed is on a sloping site, the System Sand extension = $10.5 \text{ ft.} - (5.5 \text{ ft. PLW} + 2 \text{ ft.}) = 10.5 \text{ ft.} - 7.5 \text{ ft.} = 3 \text{ ft.}$

Illustration of example #2 bed (not to scale):

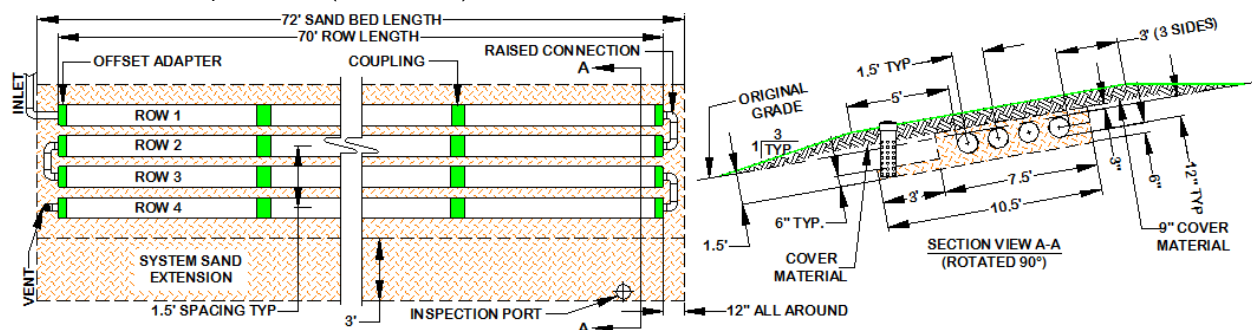

18.3 Design Example #3: Single Family Residence

Design Criteria: (4) bedroom, IN-SLR = 0.25, PR-SLR 0.37, subsurface with subsurface drainage, level site, serial distribution

Step #1: Pipe required from Table = 70 ft./bedroom x 4 bedrooms = 280 ft. minimum.

Step #2: The minimum SSBA from Table B = 1,622 ft² (600 GPD ÷ 0.37).

Step #3: Serial Section required = (4 bedrooms x 150 GPD) = 600 GPD ÷ 750 GPD/section = 0.8 → 1 = basic serial system

Step #4: A row length of 100 ft. provides 3 rows (300 ft of pipe). The System Sand bed length is the row length + 2 ft. (102 ft.).

Step #5: Table C shows a PLW of 4 ft.

Step #6: The minimum SSBW = 1,622 ft² SSBA ÷ (100 ft. row + 2 ft.) = 16 ft. min., which is greater than (4 ft. PLW + 2 ft. = 6 ft.), System Sand extensions will be present and equally divided to both sides of the rows grouped in the middle of the sand bed (basal area). The System Sand extensions = (16 ft – 6 ft) ÷ 2 = 5 ft. each.

Illustration of Design Example #3:

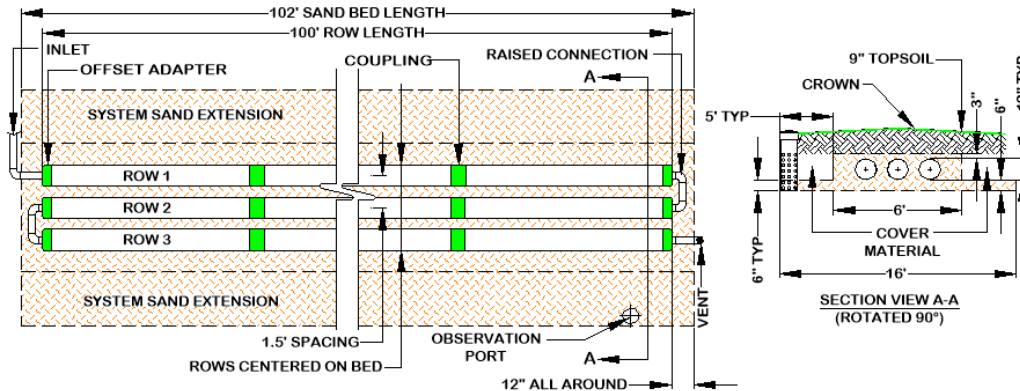

18.4 Design Example #4: Single Family Residence

Design criteria: (6) bedrooms, IN-SLR = 0.5, PR-SLR 0.75, subsurface bed (18" below grade), level site

Step #1: Pipe required from Table A = 70 ft./bedroom x 6 bedrooms = 420 ft. minimum

Step #2: The minimum SSBA from Table B = 1,200 ft²

Step #3: Serial Section required = (6 bedrooms x 150 GPD) = 900 GPD ÷ 750 GPD/section = 1.2 (round up to 2). This bed will be a Combination System, which must utilize a D-box for dividing flow.

Step #4: Choosing a row length of 70 ft. provides 6 rows (420 ft. of pipe).

Step #5: Table C shows a PLW of 8.50 ft.

Step #6: The minimum SSBW = 1,200 ft² SSBA ÷ (70 ft. row + 2 ft.) = 16.7 ft, Round up to 17. which is greater than (8.5 ft. PLW + 2 ft. = 10.5 ft.), System Sand extensions will be present and equally divided to both sides of the rows grouped in the middle of the sand bed (basal area). The System Sand extensions = (17 – 10.5 ft.) ÷ 2 = 3.25 ft. each

Illustration of example #4 bed (not to scale):

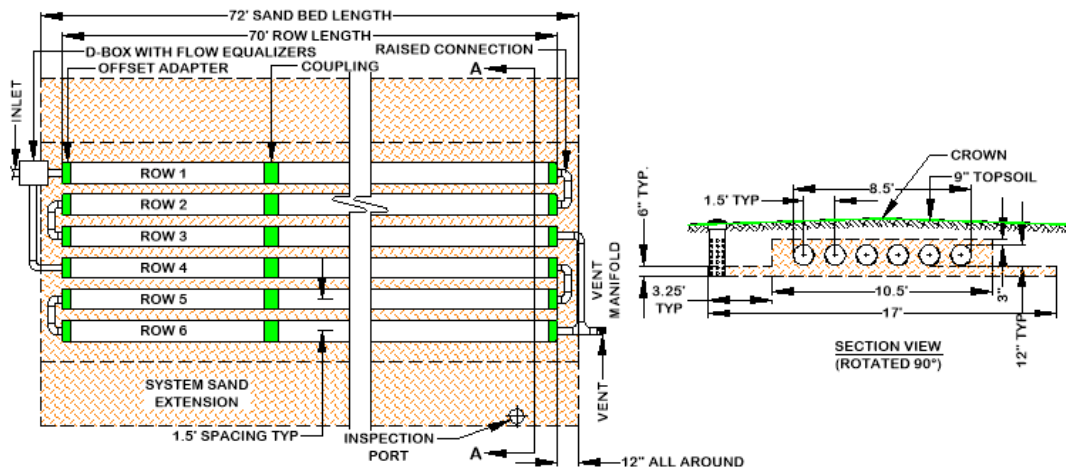

18.5 Design Procedure (Multiple Beds)

Step #1: Find the minimum quantity of pipe required from **Table A** and multiply by the number of bedrooms. Divide the pipe requirement proportionally for each bed. Example: the total number of bedrooms is (5) and two beds will be used, one bed will be sized for (2) bedrooms and one will be sized for (3) bedrooms. The pipe required for the first bed would be 140 ft. (2-bedroom x 70 ft.) and the pipe required for the second is 210 ft. (3 bedrooms x 70 ft.)

Step #2: From **Table B**, find the minimum System Sand Bed Area (SSBA) using the IN-SLR. The sand bed area is also known as the Basal Area. The SSBA is divided proportionally for each bed using the soil conditions at the location of each bed. Example using (5) bedrooms: bed #1 will be designed for (2) bedrooms with a (IN-SLR 0.6) PR-SLR of 0.9, which will require a SSBA of 334 sq. ft. ($300 \text{ GPD} \div 0.9$) and bed #2 will be designed for (3) bedrooms with a (IN-SLR 0.5) PR-SLR of 0.75, which will require a SSBA of 600 sq. ft. ($450 \text{ GPD} \div 0.75$). The total SSBA needed is 934 sq. ft.

Step #3: Calculate the number of serial sections required for each bed (skip if using parallel configuration). The serial sections required = design daily flow \div 750 GPD/section (always round up to nearest whole number).

Step #4: Select a row length that is suitable for the bed's site and calculate the number of rows required by dividing the pipe required for each bed (from Step #1) by your selected row length. The number of rows must be evenly divisible by the number of serial sections required. Increase the number of rows if needed.

Step #5: Using **Table C**, find the Pipe Layout Width (PLW) for the row length and number of rows being used in each bed.

Step #6: Calculate the minimum System Sand Bed Width (SSBW) for each bed

- a) **Beds sloping 10% or less:** Divide the SSBA from Step #2 by the (row length + 2 ft.). If this is greater than (PLW + 2 ft.), there will be a System Sand extension(s). If the bed is level: the rows are centered in the middle of the basal area. If the bed is sloping: the rows are grouped at the top of the basal area.
- b) **Beds sloping over 10%:** Divide the SSBA from Step #2 by the (row length + 2 ft.). If this is greater than or equal to (PLW + 5 ft.) no increase to the sand bed width is needed otherwise the minimum System Sand Bed Width = (PLW + 5 ft.). The System Sand extension is placed entirely on the down slope side of the bed and = System Sand bed width just calculated – (PLW + 2 ft.).

18.6 Design Example #5: Single Family Residence using Two Beds

Design criteria: (5) bedrooms total, first system (2) bedrooms in soils with an IN-SLR = 0.6 (PR-SLR 0.9), second system (3) bedrooms in soils with an IN-SLR = 0.5 (PR-SLR 0.75), both beds to subsurface (18" below grade) and on a level site.

Design first bed as a (2) bedroom system, PR-SLR = 0.9:

Step #1: Pipe required from Table A = 70 ft./bedroom x 2 bedrooms = 140 ft. minimum

Step #2: The minimum SSBA from Table B = 334 sq. ft. ($300 \text{ GPD} \div 0.9 = 334 \text{ sq. ft.}$)

Step #3: Serial Section required = (2 bedrooms x 150 GPD) = 300 GPD \div 750 GPD/section = 0.4 (round up to 1). This bed will be a Basic Serial System.

Step #4: Choosing a row length of 70 ft. provides 2 rows (140 ft. of pipe).

Step #5: Table C shows a PLW of 2.50 ft.

Step #6: a) The minimum SSBW = 334 sq. ft. \div (70 ft. row + 2 ft.) = 4.64 ft. (round up to 4.75), which is greater than (2.5 ft. PLW + 2 ft. = 4.5 ft.), System Sand extensions will be present and equally divided to both sides of the rows grouped in the middle of the sand bed (basal area). The System Sand Extensions = (4.75 ft. – 4.5 ft.) \div 2 = 0.125 ft. each. b) does not apply because bed is level.

Illustration of Bed 1:

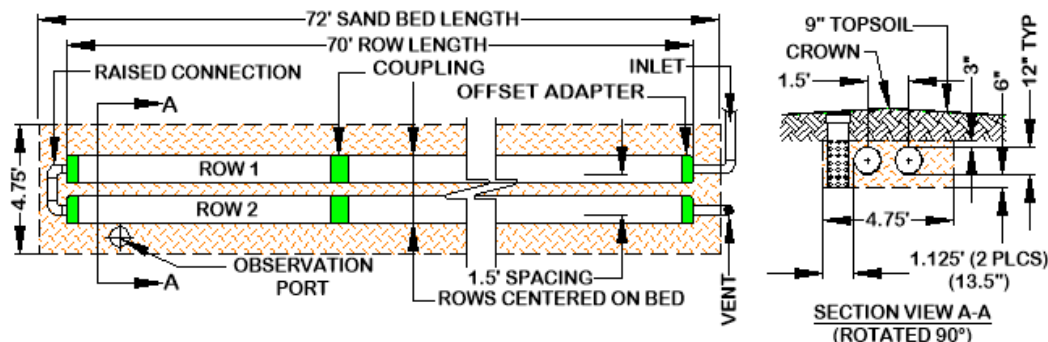

Design second bed as a (3) bedroom system, PR-SLR = 0.75:

Step #1: Pipe required from Table A = 70 ft./bedroom x 3 bedrooms = 210 ft. minimum

Step #2: The minimum SSBA from Table B = 600 sq. ft. (450 GPD ÷ 0.75 = 600 sq. ft.)

Step #3: Serial Section required = (3 bedrooms x 150 GPD) = 450 GPD ÷ 750 GPD/section = 0.6 (round up to 1). This bed will be a Basic Serial System.

Step #4: Choosing a row length of 70 ft. provides 3 rows (210 ft. of pipe).

Step #5: Table C shows a PLW of 4.0 ft.

Step #6: The minimum SSBW = 600 sq. ft. SSBA ÷ (70 ft. row + 2 ft.) = 8.34 ft., which is greater than (4 ft. PLW + 2 ft. = 6 ft.), System Sand extensions will be present and equally divided to both sides of the rows grouped in the middle of the sand bed (basal area). The System Sand extensions = (8.34 ft. – 6 ft.) ÷ 2 = 1.17 ft. each (use 1.5 ft. for ease of construction). This will make the final sand bed width 9 ft.

Illustration of Bed 2:

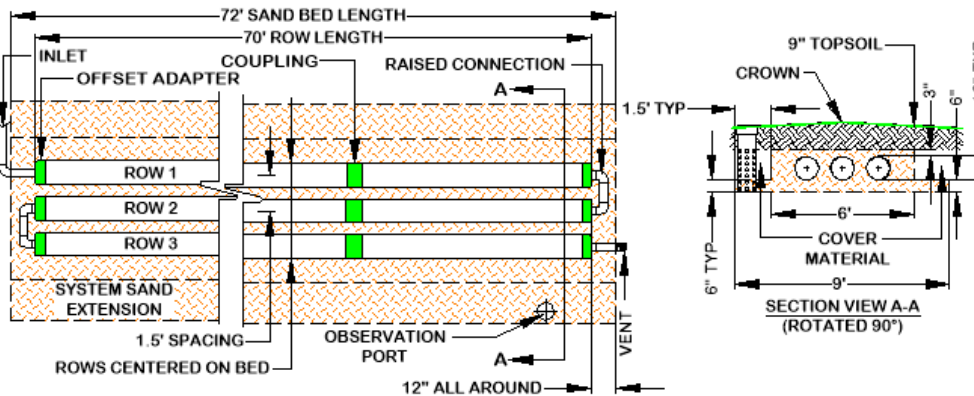

A splitter box will be used to divide flow proportionally to each treatment field (other methods allowed, if approved). Two and three distribution box outlets respectively will be manifolded together and directed to the appropriate system. Illustration of Proportional Flow Splitter Box:

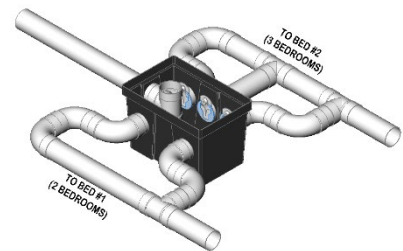
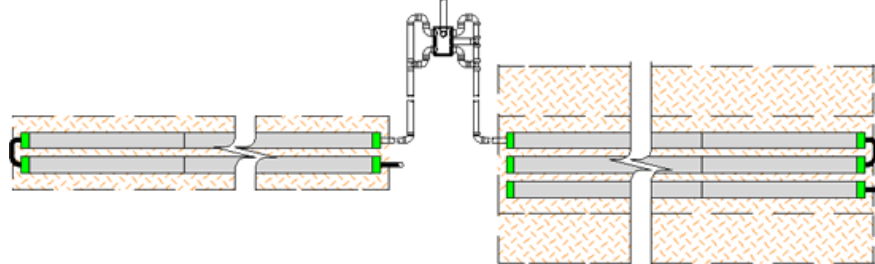

Illustration of design example (both beds):



19.0 Pumping & Dosing

Pumped systems supply effluent to the field using a pump and distribution box when gravity is not possible or if the system requires dosing. Dosing siphons are an acceptable means of delivering effluent to a gravity feed AES system.

19.1 Siphon Dosing Gravity Systems

Dosing siphons are used with gravity feed systems to provide a measured dose of effluent. Unlike pumps, siphons are not used to gain elevation and are not required by Presby Environmental but offered as an acceptable method for dosing gravity feed fields. As with pumping, velocity reduction is required when using dosing siphons. See Velocity Reduction, para. 19.5 below.

19.2 Alarm

Indiana requires all pump systems to have a high-water alarm float or sensor installed inside the pump chamber.

19.3 Differential Venting

All pump systems and dosing siphons must use differential venting (see Differential Venting, para.20.2, below).

19.4 Distribution Box

All pump systems require a distribution box.

19.5 Velocity Reduction

The rate at which effluent enters the AES pipe must be controlled. Excessive effluent velocity can disrupt solids that settle in the pipes.

- a) Effluent must never be pumped directly into AES pipes.
- b) Force mains must discharge into a distribution box which includes a Rule-compliant baffle, 90° bend with weep hole, tee or equivalent.

19.6 Dose Volume

- a) Pump volume per dose must be no greater than 1-gallon times the total linear feet of AES pipe.
- b) Pump dosing should be designed for a minimum of 6 cycles per day ($\leq 1/6$ of Daily Design Flow).
- c) If possible, the dosing cycle should provide one hour of drying time between doses.

19.7 Basic Serial Distribution Limit

Pumped systems with Basic Serial distribution are limited to a maximum dose rate of 40 GPM. Never pump directly into AES pipe.

20.0 Venting Requirements

20.1 General Rules

- a) Adequate air supply is essential to the proper functioning of the system.
- b) Venting as described below is required for all systems.
- c) Vent openings must be located to ensure the unobstructed flow of air through the entire system.
- d) The low vent inlet must be a minimum of 1 ft. above final grade.
- e) One 4 in. vent is required for every 1,000 feet of AES pipe.
- f) A single 6 in. vent may be installed in place of up to three 4 in. vents.
- g) If a vent manifold is used, it must be the same diameter as the vent(s).
- h) When venting multiple beds, it is preferred that each bed be vented separately rather than manifolding bed vents together.
- i) Remote Venting (see, para. 20.5, pg. 20) may be utilized to minimize the visibility of vent stacks.

20.2 Differential Venting

- a) Differential venting is the use of high and low vents in a system.
- b) In a gravity system, the roof stack acts as the high vent. If the building has no roof vent, a high vent must be added. It can be attached to a D-box, which is then attached to the field. It can also be attached to the sewer line feeding or leaving the septic tank. Consult the factory if these options are not possible.
- c) High vents must be adequately supported. See illustration below.
- d) High and low vent openings must be separated by a minimum of 10 vertical feet.
- e) If possible, the high and low vents should be of the same capacity.
- f) Sch. 40 PVC or equivalent should be used for all portions of the vent that extends above the ground.

20.3 Pump System Vent Locations

- a) A low vent is installed through an offset adapter at the end of each section, Basic Serial bed or attached to a vent manifold.
- b) A high vent is installed through an unused distribution box outlet (see diagram below).
- c) A 10 ft. minimum vertical differential is required between high and low vent openings.
- d) When venting multiple beds, it is preferred that each bed be vented separately (have their own high and low vents) rather than manifolding bed vents together.
- e) Illustration of Differential Venting for Pump Systems:
Note: the low vent may be attached to the D-box and the high vent attached to the end of the last row (or manifold) only when the D-box is insulated against freezing.

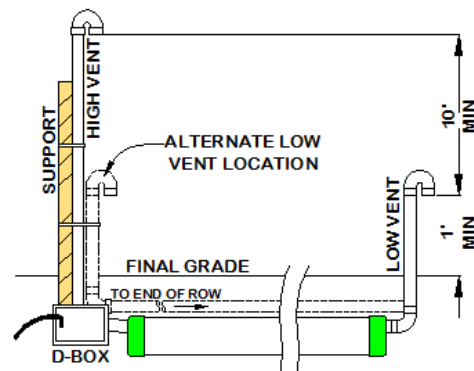

20.4 Vent Locations for Gravity Systems

- A low vent through an offset adapter is installed at the end of the last row of each section or the end of the last row in a Basic Serial bed, or at the end of each row in a Parallel Distribution Configuration system. A vent manifold may be used to connect the ends of multiple sections or rows.
- The house (roof) vent functions as the high vent as long as there are no restrictions or other vents between the low vent and the house (roof) vent.
- There must be a minimum of a 10 ft. vertical differential between the low and high vent openings.

Illustration of Gravity System Air Flow:

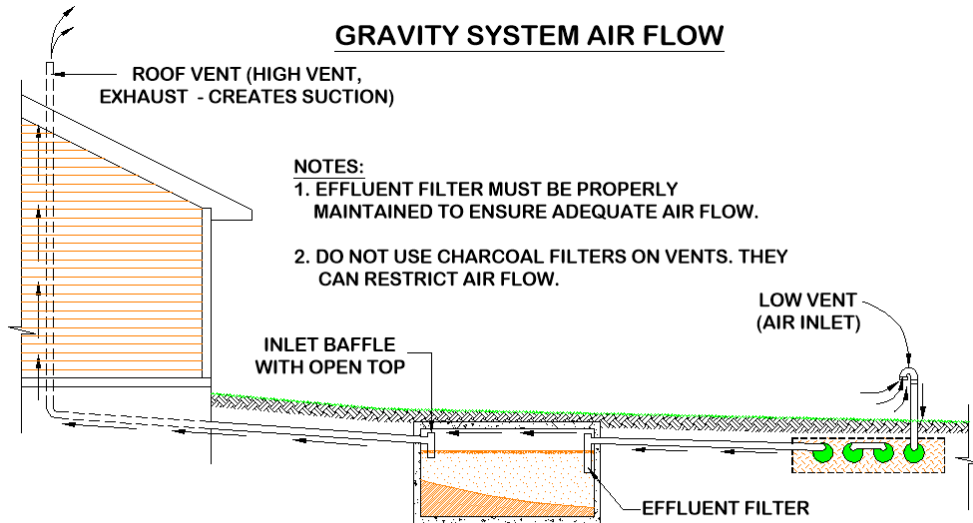

VENTING IS ESTABLISHED THROUGH SUCTION (CHIMNEY EFFECT) CREATED BY THE DRAW OF AIR FROM THE HIGH VENT, WHICH DRAWS AIR FROM THE LOW VENT, THROUGH THE LEACH FIELD, THROUGH THE SEPTIC TANK, AND EXHAUSTED THROUGH THE (HIGH) ROOF VENT.

20.5 Remote Venting

If site conditions do not allow the vent pipe to slope toward the system, or the owner chooses to utilize remote venting for aesthetic reasons (causing the vent pipe not to slope toward the system), the low point of the vent line must be drilled with several 1/4 in. holes to allow drainage of condensation. This procedure may only be used if the vent pipe connecting to the system has a high point that is above the highest point of the AES pipes or the D-box and the low point opened for drainage (1/4 in. holes).

Illustration of Remote Venting:

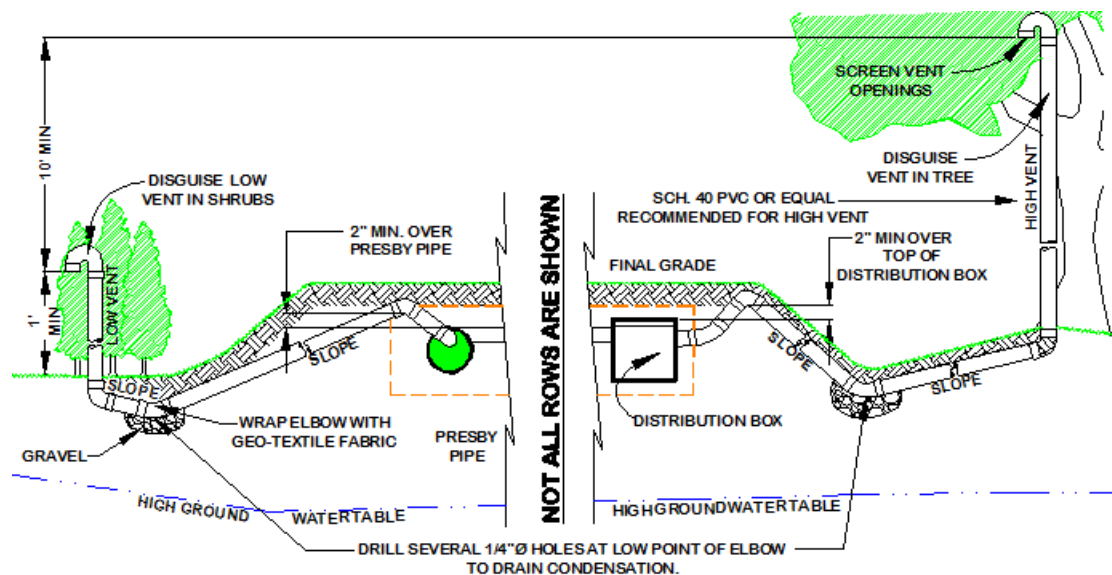

20.6 By-Pass Venting

When a field is fed using pumping or dosing, it is necessary to provide air flow through the system by using “by-pass venting”. In by-pass venting, the system is plumbed by attaching Sch. 40 PVC to the D-box- back to the septic tank. This process “by-passes” the pump chamber and allows air to flow from the low vent to the roof vent which acts as the high vent.

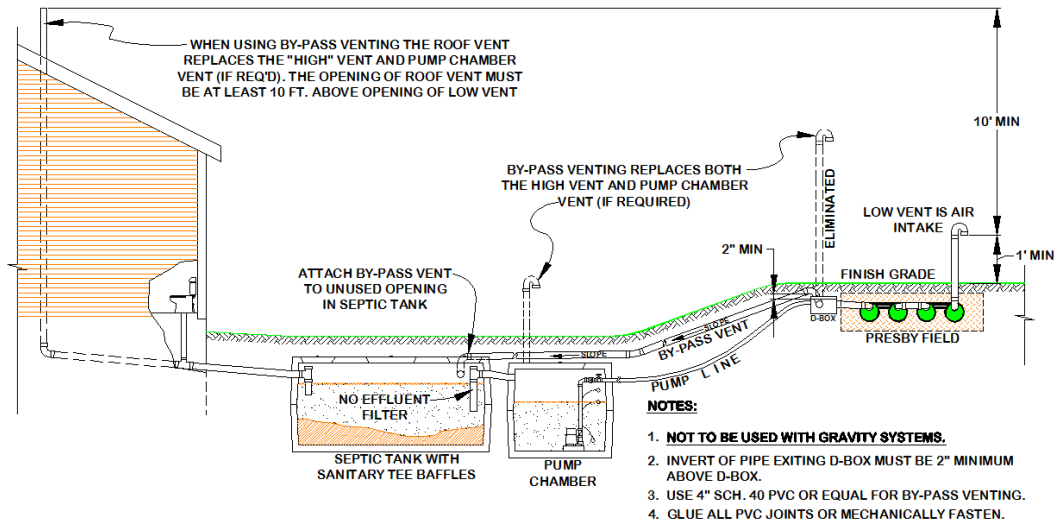

20.7 Vent Manifolds

For Combination systems, a vent manifold may be incorporated to connect the ends of a number of sections to a single vent opening. However, D-box (Parallel) Configurations require the ends of all rows to be manifolded together. The vent stack must be attached to the manifolded rows. See diagrams below.

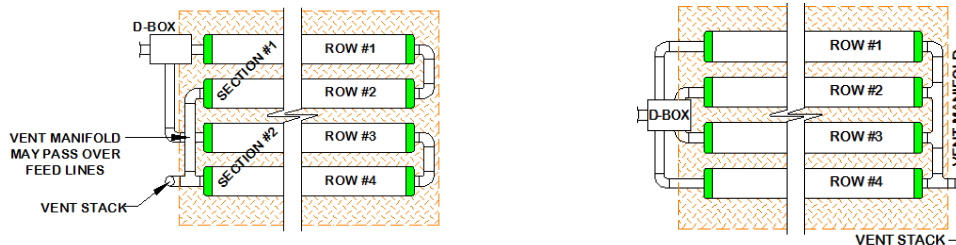

20.8 Vent Piping Slope

Vent piping should slope downward toward the system to prevent moisture from collecting in the pipe and blocking the passage of air.

21.0 Site Selection

21.1 Access

Systems should be located to allow access for septic tank maintenance and to at least one end of all rows. Planning for future access will facilitate Rejuvenation in the unlikely event the system malfunctions. (See System Bacteria Rejuvenation and Expansion, para. 23.0, pg. 25.)

21.2 Common Causes of Excessive Hydraulic Loading

While an onsite system can easily handle isolated, occasional surges in volume either of effluent or storm water runoff, prolonged dosing in excess of what the system was designed to handle can be problematic. Some of the more common sources of excess hydraulic loading discovered were the result of drain or gutter systems discharging into or near the treatment field, inadequate perimeter drains, ineffective surface diversion installations, and leaking septic tank connections. These are the most common installation errors contributing to hydraulic overloading of onsite systems. Also, leaks in the plumbing system can also result in overloading the onsite system and should be repaired immediately. Care should be taken to ensure that the septic tank and all of its connections, access ports, risers, etc. are properly sealed and watertight to prevent ground water from infiltrating and overburdening the system.

21.3 Determining Site Suitability

Refer to Indiana Rules regarding site suitability requirements.

21.4 Hydraulic Loading

Systems should not be located where lawn irrigation, roof drains, or natural flows increase water loading to the soils around the system. Systems should not be located where structures such as curbs, walls or foundations might adversely restrict the soil's ability to transport water away from the system.

21.5 Reserve (Set-Aside) Area

Presby Environmental does not require a reserve or set-aside area for future use as a system replacement location in the unlikely event a Presby system malfunctions, which can often be rejuvenated (see para.23.0, pg. 25). Presby fields may be constructed in the same location as failed systems provided all the contaminated materials are removed and replaced. Contact our Technical Support for recommendations (800-473-5298). Secure the required state and local permits/approvals prior to beginning any work

21.6 Subsurface Drainage/Surface Diversions

See para. 14.0 on pg. 12

21.7 Systems under Traffic Bearing Surfaces

The State of Indiana does not permit systems to be installed under traffic bearing surfaces.

21.8 Topography

Locate systems on convex, hill slope or level locations that do not concentrate surface flows. Avoid swales, low areas, or toe-of-slope areas that may not provide sufficient drainage away from the system.

22.0 Installation Requirements, Component Handling and Site Preparation

22.1 Component Handling

- a) Keep mud, grease, oil, etc. away from all components.
- b) Avoid dragging pipe through wet or muddy areas.
- c) Store pipe on high and dry areas to prevent surface water and soil from entering the pipes or contaminating the fabric prior to installation.
- d) The outer fabric of the AES pipe is ultra-violet stabilized; however, this protection breaks down after a period of time in direct sunlight. To prevent damage to the fabric, cover the pipe with an opaque tarp if stored outdoors.

22.2 Critical Reminder Prevent Soil Compaction

It is critical to keep construction equipment off the excavated or tilled surface of a bed. Before installing the System Sand, excavation equipment should be operated around the bed perimeter, not on the bed itself and never directly down slope of the field for sloping systems.

22.3 Site Preparation Prior to Excavation

- a) Locate and stake out the System Sand bed, extension areas and soil material cover extensions on the site according to the approved plan.
- b) Install sediment/erosion control barriers prior to beginning excavation to protect the system from surface water flows during construction.
- c) Do not travel across or locate excavation equipment within the portion of the site receiving System Sand.
- d) Do not stockpile materials or equipment within the portion of the site receiving System Sand.
- e) It is especially important to avoid using construction equipment down slope of the system to prevent soil compaction.

22.4 When to Excavate

Do not work wet or frozen soils (see Indiana 410 IAC 6-8.3-74(e) for residential systems or 410 IAC 6-10.1-82(e) for commercial systems, for complete instructions and testing criteria). Do not excavate the system area immediately after, during or before precipitation.

22.5 Tree Stumps

Cut and remove excessive vegetation at the bed site.

- a) If possible, locate the system on the site such that no tree stumps greater than 3" in diameter are located in the system bed or dispersal area.
- b) Avoid soil disturbance, relocation, or compaction.
- c) Avoid mechanical leveling or tamping of dislodged soil.
- d) Fill all voids created by unintentional stump or root removal with System Sand.

22.5.1 Elevated Systems

- a) Cut tree stumps 3 inches in diameter and smaller, measured at the ground surface, flush with the ground surface.
- b) Remove tree stumps larger than 3 inches in diameter, measured at the ground surface, and the central root system below grade.
- c) Use a backhoe or excavator with a mechanical "thumb" or similar extrication equipment, lifting or leveraging stump in a manner that minimizes soil disturbance.
- d) Fill all voids created by stump removal with System Sand
- e) If possible, do not locate the down slope edge of the system bed directly above tree stumps greater than 3" in diameter.

22.5.2 Subsurface Systems

- a) Remove all tree stumps and the central root system below grade.
- b) Use a backhoe or excavator with a mechanical "thumb" or similar extrication equipment, lifting or leveraging stump in a manner that minimizes soil disturbance.
- c) Fill all voids created by stump removal with System Sand.

22.6 Organic Material Removal

Before tilling, remove all grass, leaves, sticks, brush and other organic matter or debris from the excavated system site. Do not remove topsoil for elevated systems. It is not necessary for the soil of the system site to be smooth when the site is prepared.

22.7 Raking and Tilling Procedures

All areas receiving System Sand, sand fill and cover material extensions must be raked or tilled. If a backhoe/excavator is used to till the site, fit it with chisel teeth and till the site. The excavator should remain outside of the proposed System Sand area and extensions. When installing System Sand, keep at least 6" of System Sand between the vehicle tracks and the tilled soil of the site. Equipment with tires should be avoided due to likely wheel compaction of underlying soil structures.

22.7.1 Proper Tilling Procedures

- a) If a chisel plow or a bulldozer with a ripper is used, make only one pass parallel to the contour of the site.
- b) If a moldboard plow is used, it must have at least 2 bottoms and make only one pass parallel to the contour of the site. On slopes greater than ½%, turn the furrows upslope.
- c) If a backhoe/excavator is used to till a wooded site, fit it with chisel teeth, till the site using the chisel teeth, and keep the backhoe on untilled soil at all times.
- d) If a plow pan exists not exceeding 12" from the original grade, till the soil to at least 2" below the bottom of the plow pan.
- e) The state or local department of health may require field supervision of tilling operations.

22.7.2 Subsurface Systems

- a) For in-ground bed systems, excavate the system bed area to a depth of at least 4 in. below original grade.
- b) Using an excavator or backhoe, tilt the bucket teeth perpendicular to the bed and use the teeth to rake furrows 2 in.- 6 in. deep into the bottom of the entire area receiving System Sand or sand fill ("receiving area").
- c) After tilling the site, cut off all roots that protrude above the tilled surface (without compaction of the soil material).
- d) Remove all stumps, organic material, stones larger than 6", and construction debris
- e) Add 6 in. of System Sand (measured from the original grade) to the excavated site on the same day the system is excavated and before any precipitation.

22.7.3 Elevated Systems

The site for elevated systems shall be prepared in accordance with Indiana 410 IAC 6-8.3-86 and -87 for residential systems, or 410 IAC 6-10.1-94 and -95 for commercial systems, or the most current version of the rules that control this practice. After preparing the surface place at least 12 inches of System Sand (IN DOT 23 sand) on the prepared surface before placing the AES pipes.

22.8 Install System Sand and/or Sand Fill Immediately After Excavation

- a) To protect the tilled area (System Sand bed area and System Sand extension area) from damage by precipitation, System Sand should be installed immediately after tilling (6 in. for below grade and 12 in. for elevated systems).

- b) When installing the System Sand, work off either end or the uphill side of the system to avoid compacting soil (see “Critical Reminder” in para. 22.2, pg. 22).
- c) When installing System Sand, keep at least 6 in. of sand between the vehicle tracks and the tilled soil of the site if equipment must work on receiving soil.
- d) Track construction equipment should not travel over the installed system area until at least 12 in. of cover material is placed over the pipes.
- e) Heavy equipment with tires must never enter the receiving area due to likely wheel compaction of underlying soil structures.

22.9 Distribution Box Installation

To prevent movement, be sure D-boxes are placed level on compacted soil, sand, pea gravel base, or concrete pad.

22.10 Level Row Tolerances

Use a laser level or transit to install rows level. Variations beyond a total of 1 in. ($\pm 1/2$ in.) may affect system performance and are not acceptable.

22.11 Correct Alignment of Bio-Accelerator®

The Bio-Accelerator (white geo-textile fabric) is to be positioned centered along the bottom of the pipe rows with the sewn seam up (12 o'clock position).

22.12 Row Spacers

System Sand may be used to keep pipe in place while covering, but simple tools may also be constructed for this purpose. Two examples are shown below. One is made from rebar, the other from wood. Grade stakes may also be used. Caution: Remove all tools used as row spacers before final covering.

Two methods for spacing pipe for backfill.

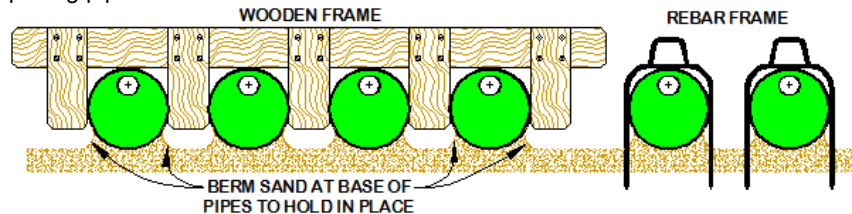

22.13 Connect Rows Using Raised Connections

Raised connections consist of offset adapters, 4 in. PVC sewer and drain pipe, and 90° elbows. They enable greater liquid storage capacity and increase the bacterial surfaces being developed. Use raised connections to connect the rows of the AES system.

22.14 Backfilling Rows

- a) Confirm pipe rows are positioned with Bio-Accelerator along the bottom with the sewn seam up (12 o'clock position).
- b) Spread System Sand between the rows.
- c) Straddle each row of pipe and walk heel-to-toe its entire length, ensuring that System Sand fills all void spaces beneath the AES pipe.
- d) Finish spreading System Sand to the top of the rows and leave them exposed for inspection purposes.

22.15 Backfilling and Final Grading

Spread System Sand to a minimum of 3 in. over the pipe and a minimum of 12 in. beyond the AES pipe on all four sides. Spread soil material free of organics, stones over 4 in. and building debris having a texture similar to the soil at the site, without causing compaction. Construction equipment should not travel over the installed system area until at least 12 in. of cover material is placed over the AES pipes (H-10 Loading). 18 in. of cover material over the system is required for H-20 loading. Vehicular traffic is not allowed on systems in Indiana at this time.

22.16 System Soil Cover Material

A minimum of 9 inches of suitable earth cover (topsoil or loam), with a texture similar to the soil at the site and capable of sustaining plant growth, must be placed above the installed system (see para. 6.13, pg. 7).

22.17 Erosion Control

To prevent erosion, soil cover above the system shall be planted with native, shallow-rooted vegetation such as grass, wildflowers and certain perennials or ground covers.

22.18 Trees and Shrubs

Trees or shrubs should not be located within 10 ft. of the system or D-boxes to prevent roots from growing into and damaging the system.

23.0 System Bacteria Rejuvenation and Expansion

This section covers procedures for bacteria rejuvenation and explains how to expand existing systems. Presby Environmental, Inc. must be contacted for technical assistance prior to attempting rejuvenation procedures.

23.1 Why would System Bacteria Rejuvenation be needed?

Bacteria rejuvenation is the return of bacteria to an aerobic state. Flooding, improper venting, alteration or improper depth of soil material cover, use of incorrect sand, sudden use changes, introduction of chemicals or medicines, and a variety of other conditions can contribute to converting bacteria in any system from an aerobic to an anaerobic state. This conversion severely limits the bacteria's ability to effectively treat effluent, as well as limiting liquids from passing through. With the exception of Simple-Septic, a unique feature of the AES systems are their ability to be rejuvenated in place.

23.2 How to Rejuvenate Bacteria

System bacteria are "rejuvenated" when they return to an aerobic state. By using the following procedure, this can be accomplished in most AES systems without costly removal and replacement. Caution: This procedure must be followed in such a way as to not create a public health hazard:

1. Contact ISDH for the appropriate permit.
2. Contact Presby Environmental before attempting Rejuvenation for technical assistance.
3. Determine the problem causing the bacteria conversion.
4. Drain the system by excavating one end of all the rows and removing the offset adapters. Sewage from the system must be removed by an Indiana licensed Septic Tank Cleaner.
5. If foreign matter has entered the system, flush the pipes.
6. Safeguard the open excavation.
7. Guarantee a passage of air through the system.
8. Allow all rows to dry for 72 hours minimum. The System Sand should return to its natural color.
9. Re-assemble the system to its original design configuration. AES components are not biodegradable and may be reused as long as there is no physical damage and they are adequately cleaned.

23.3 System Expansion

Presby systems are easily expanded by adding equal lengths of pipe to each row of the original design or by adding additional equal sections. In the event that ES or SS product is not readily available, AES pipe may be used for expanding systems originally constructed with ES or SS pipe. All system expansions must comply with State and local regulations. Permits will be required prior to system expansion.

23.4 System Replacement or Repair

If a Presby system requires replacement or repair, follow the procedure outlined below. Caution: This procedure must be followed in such a way as to not create a public health hazard.

- a) An onsite soil evaluation must confirm that the soils at the site are suitable for the replacement system and a probable reason for system failure must be determined before securing the required state and local permits/approvals prior to beginning any work.
- b) Use an Indiana licensed Septic Tank Cleaner to remove any sewage, contaminated components (not being reused) or contaminated soils from the site.
- c) Replace damaged components with new AES products. If components are not damaged, they may be flushed and reused.
- d) Replace in the same excavated location with new System Sand (IN DOT 23 sand).
- e) When site conditions do not allow for a system to be designed as full-sized replacement system based upon current specifications, "in-kind" replacement using AES pipe is permitted.
- f) All system replacements or repairs must comply with State and Local regulations.

24.0 Operation & Maintenance

24.1 Proper Use

The Advanced Enviro-Septic Wastewater Treatment System requires minimal maintenance provided the system is not subjected to abuse. An awareness of proper use and routine maintenance will guarantee system longevity. We encourage all system owners and service providers to obtain and review a copy of our Owner's Manual, available

from our website www.PresbyEnvironmental.com or via mail upon request to (800) 473-5298 or info@presbyeco.com.

24.2 System Abuse Conditions

The following conditions constitute some examples of system abuse:

- a) Liquid in high volume (excessive number of occupants, excessive use of water in a short period of time, leaking fixtures, whirlpool tubs, hot tubs, water softening equipment or additional water discharging fixtures if not specified in system design).
- b) Solids in high volume (excessive number of occupants, paper products, personal hygiene products, garbage disposals or water softening equipment if not specified in system design)
- c) Antibiotic medicines in high concentrations
- d) Cleaning products in high concentrations
- e) Fertilizers or other caustic chemicals in any amount
- f) Petroleum products in any amount
- g) Latex and oil paints
- h) System suffocation (compacted soils, barrier materials, etc.)
- i) Special Note: Presby Environmental, Inc. and most regulatory agencies do not recommend the use of septic system additives.

24.3 System Maintenance/Pumping of the Septic Tank

- a) Inspect the septic tank at least once every two years under normal usage.
- b) Pump the tank when surface scum and bottom sludge occupy one-fourth or more of the liquid depth of the tank (only use a licensed Septic Tank Cleaner for sewage removal).
- c) If a garbage disposal is used, the septic tank will likely require more frequent pumping.
- d) After pumping, inspect the septic tank for integrity to ensure that no groundwater is entering it. Also check the integrity of the tank inlet and outlet baffles and repair if needed.
- e) Inspect the system to ensure that vents are in place and free of obstructions.
- f) Effluent filters require ongoing maintenance due to their tendency to clog and cut off oxygen to the system. Follow filter manufacturer's maintenance instructions and inspect filters frequently.

24.4 Site Maintenance

It is important that the system site remain free of shrubs, trees, and other woody vegetation to within a minimum of 10 ft. of the system, including the entire System Sand bed area, and areas impacted by side slope tapering and perimeter drains (if used). Roots can infiltrate and cause damage or clogging of system components. If a perimeter drain is used, it is important to make sure that the outfall pipes are screened to prevent animal activity. Also check outfall pipes regularly to ensure that they are not obstructed in any way.

25.0 Glossary

This Manual contains terminology which is common to the industry and terms that are unique to the AES system. While alternative definitions may exist, this section defines how these terms are used in this Manual.

25.1 Advanced Enviro-Septic® (AES) Pipe

A single unit comprised of corrugated plastic pipe, Bio-Accelerator® fabric (see illustration in para. 2.0, pg. 2, and description in para. 25.4, pg. 27) along its bottom which is surrounded by a layer of randomized plastic fibers and a sewn geo-textile fabric, is 10 ft. in length, with an outside diameter of 12 in. and a storage capacity of approximately 58 gallons. Each foot of AES provides over 40 sq. ft. of total surface area for bacterial activity. The sewn seam is always oriented up (12 o'clock position) within the bed. A white tag is sewn into the seam indicating the product is Advanced Enviro-Septic pipe. Pipes are joined together with couplings to form rows. Advanced Enviro-Septic is a combined wastewater treatment and dispersal system.

25.2 Enviro-Septic® (ES) Pipe

A single unit comprised of corrugated plastic pipe which is surrounded by a layer of randomized plastic fibers and a sewn geo-textile fabric, is 10 ft in length, with an outside diameter of 12 in. and a storage capacity of approximately 58 gallons. Each foot of Enviro-Septic provides over 25 sq. ft. of total surface area for bacterial activity. A white tag is sewn into the seam indicating the product is Enviro-Septic pipe. Pipes are joined together with couplings to form the rows. Enviro-Septic is a combined wastewater treatment and dispersal system.

25.3 Basic Serial Distribution

Basic Serial distribution incorporates AES pipe rows in serial distribution in a single bed. See Basic Serial Distribution in para. 7.0, pg. 8.

25.4 Bio-Accelerator®

Bio-Accelerator fabric screens additional solids from the effluent, enhances and accelerates treatment, facilitates quick start-up after periods of non-use, provides additional surface area for bacterial growth, promotes even distribution, and further protects outer layers and the receiving surfaces so they remain permeable. Bio-Accelerator is only available with Advanced Enviro-Septic pipe.

25.5 Butterfly Configuration

A variation of a standard, single bed system with the D-box located in the center, with rows oriented symmetrically on either side, and with each side or section receiving an equal volume of flow from the D-box. See Butterfly Configuration, para. 9.0, pg. 10.

25.6 Center-to-Center Spacing

The distance from the center of one pipe row to the center of the adjacent row.

25.7 Coarse Randomized Fiber

A mat of coarse, randomly-oriented fibers which separates more suspended solids from the effluent protecting the bacterial surface in the geo-textile fabric (see illustration in para. 2.0, pg. 2).

25.8 Combination Serial Distribution

Incorporates two or more sections of AES pipe in a single bed, with each section receiving a maximum of 750 GPD of effluent from a distribution box (see para. 8.0, pg. 9).

25.9 Cooling Ridges

Pipe ridges that allow the effluent to flow uninterrupted around the circumference of the pipe and aid in cooling (see illustration in para. 2.0, pg. 2).

25.10 Coupling

A plastic fitting that joins two AES pipe pieces in order to form rows. See para. 3.3, pg. 3.

25.11 Cover Material Extension

Utilized in constructing Elevated Systems and blending the raised portion of the system with side slope tapering to meet existing grade (see illustrations in para. 6.12, pg. 7). For all systems, the cover material extensions are 3 ft. minimum on all sides, measured from the AES pipe. Systems sloping greater than 10% require a 5 ft. cover material extension on only the down slope side of the field.

25.12 Design daily flow

The peak daily flow of wastewater to a system, expressed in gallons per day (GPD); systems are typically sized based on the design daily flow. Design flow calculations are set forth in the Indiana Rules. In general, actual daily use is expected to be one-half to two-thirds of the "design daily flow."

25.13 Differential Venting

A method of venting a system utilizing high and low vents. See Venting Requirements, para. 20.2, pg. 19.

25.14 Distribution Box or "D-box"

A distribution box is a device designed to distribute effluent from the septic tank equally to each of the outlet pipes that carry effluent into the system. D-boxes are also used for velocity reduction, see Velocity Reduction, para. 19.5, pg. 19.

25.15 Distribution Box Manifold

A PVC configuration which connects several distribution box outlets together in order to equalize effluent flow. Refer to drawing in para. 5.4, pg. 4.

25.16 Elevated Bed System

A soil absorption field with the infiltrative surface less than 4 inches below the original grade or higher. Elevated systems utilize 12 in. of System Sand below all the pipes.

25.17 End-to-End Configuration

Consists of two or more beds constructed in a line (i.e., aligned along the width of the beds). A butterfly system is not considered an end-to-end configuration, but a single bed.

25.18 Flow Equalizer

An adjustable plastic insert installed in the outlet pipes of a D-box to equalize effluent distribution to each outlet.

25.19 GPD

An acronym for Gallons per Day.

25.20 GPM

An acronym for Gallons per Minute.

25.21 High and Low Vents

Pipes used in differential venting. Detailed information about venting requirements can be found in Venting Requirements, para. 20.0, pg. 19.

25.22 IN DOT

An acronym for Indiana Department of Transportation.

25.23 Infiltrative surface

The surface used for the absorption of effluent by soil. For *subsurface bed systems*, bed sidewalls are not included in the calculation of the total infiltrative surface area required for the soil absorption field. For *elevated bed systems*, the infiltrative surface is the original grade.

25.24 Multiple Bed Distribution

Incorporates two or more beds, each bed with Basic Serial, Combination Serial, or Parallel distribution and receiving effluent from a distribution box.

25.25 Non-Conventional Configurations

Have irregular shapes or row lengths in order to accommodate site constraints. See Non-conventional Configurations, para. 13.0, pg. 12.

25.26 Offset Adapter

A plastic fitting with a 4-in. hole installed at the 12 o'clock position which allows for connections from one row to another and for installation of venting (see para. 3.2, pg. 3).

25.27 Parallel Configuration

A design in which each AES row receives effluent from a distribution box outlet. Such a system is also called a "parallel system" or a "finger system." See D-box (Parallel) Distribution, para. 7.1, pg. 9.

25.28 Pressure Distribution

Pressure distribution is a pressurized, small-diameter pipe system used to deliver effluent to an absorption field. The AES system is designed to promote even distribution without the need for pressure distribution.

25.29 Pump Systems

Utilize a pump to gain elevation in order to deliver effluent to a distribution box (see para. 19.0, pg. 18).

25.30 Raised Connection

A U-shaped, 4" diameter, PVC pipe configuration which is used to connect rows oriented in a serial configuration and to maintain the proper liquid level inside each row. See drawing in Raised Connection, para. 3.4, pg. 3.

25.31 Raking and Tilling

Refers to methods of preparing the native soil that will be covered with System Sand or Sand Fill, creating a transitional layer between the sand and the soil (see para. 22.7, pg. 23).

25.32 Row

Consists of a number of AES pipe sections connected by couplings with an offset adapter on the inlet end and an offset adapter or double offset adaptor on the opposite end. Rows are typically between 30 ft. and 100 ft. long.

25.33 Sand Fill (IN DOT 23 Sand)

Clean sand, free of organic materials and meeting the specifications set forth in System Sand and Fill Material Specifications, para. 6.11, pg. 7. Sand fill is used to raise the elevation of the system to meet required separation distance or in side slope tapers. System Sand (IN DOT 23 sand) is used for Sand Fill.

25.34 Section / Serial Section

A group of interconnected rows receiving effluent from one distribution box outlet. Each Serial Section is limited to 750 GPD design daily flow. More than one Serial Section forces the use of Combination Serial Distribution (see para. 8.0, pg. 9).

25.35 Segment Drain

A segment drain is a subsurface drainage system that is constructed between two beds in the same on-site sewage system to intercept and divert subsurface water away from the downslope soil absorption field.

25.36 Serial Distribution

Two or more AES rows connected by a raised connection. Basic Serial distribution is described in detail in para. 7.0, pg. 8; Combination Serial distribution is described in detail in para. 8.0, on pg. 9.

25.37 SHWT

An acronym for Seasonal High-Water Table.

25.38 Skimmer Tabs

Projections into the AES pipe that help to capture grease and suspended solids from the existing effluent (see illustration in para. 2.0, pg. 2).

25.39 Side-to-Side Configuration

Consist of two or more beds arranged so that the rows are parallel to one another.

25.40 Slope (3:1)

In this Manual's illustrations, slope is expressed as a ratio of run to rise. Example: A slope with a grade of three to one (3:1) is the difference in horizontal distance of three (3) horizontal feet (run) over an elevation difference of one (1) ft. (rise).

25.41 Slope (%)

Expressed as a percent, is the difference in elevation divided by the difference in horizontal distance between two points on the surface of a landform. Example: A site slope of one (1) percent is the difference in elevation of one (1) foot (rise) over a horizontal distance of one hundred (100) feet (run).

25.42 Smearing

The mechanical sealing of soil air spaces along an excavated, tilled or compressed surface. This is also referred to as "compacting." In all installations, it is critical to avoid smearing or compacting the soils under and around the system.

25.43 Surface Diversion

A natural or manmade barrier that changes the course of surface flow of water around an onsite system's soil absorption field.

25.44 System Sand Bed

System Sand area required/used in AES systems extends a minimum of 6 in. below (subsurface systems), 12 in. below (elevated systems), 3 in. above and 12 in. horizontally from the outside edges of the pipes in the system.

25.45 System Sand Extension Area

Any portion of the System Sand bed that is more than 1 ft. away from the AES pipe. The System Sand extension area is a minimum of 6 in. deep (see illustration in para. 6.6, pg. 6).

25.46 Subsurface (In-ground) Bed System

A soil absorption field with the infiltrative surface (bottom of the System Sand bed) a min. of 4" below original grade.

25.47 Topsoil Material

Topsoil, also known as Loam, is soil material cover capable of sustaining plant growth which forms the topmost layer of cover material above the system.

26.0 Indiana System Installation Form

Installers must complete and fax or mail a copy of this form to the local approving authority and to:
Presby Environmental, Inc., 143 Airport Rd, Whitefield, NH 03598 Fax: (603) 837-9864

Installer's Name:		Installer's PEI Certification Number:	
Company Name:			
Street Address:			
City:		State:	Zip:
Installer's Phone Number:			
Designer's Name:		Company Name:	
Street Address:			
City:		State:	Zip:
Phone Number:			
Property Owner(s):			
Site Street Address:			
City:		State:	Zip:
System Information (<i>check all that apply</i>):			
<input type="checkbox"/> New Construction	<input type="checkbox"/> Replacement System	<input type="checkbox"/> System Repair	
<input type="checkbox"/> Elevated System	<input type="checkbox"/> Subsurface System		
<input type="checkbox"/> Gravity Fed	<input type="checkbox"/> Pump to D-box		
<input type="checkbox"/> Basic Serial Distribution	<input type="checkbox"/> Parallel Distribution	<input type="checkbox"/> Combination Serial Distribution	
<input type="checkbox"/> Effluent Filter Used			
Number of Beds: _____ Design Flow (bedrooms or GPD): _____ Indiana Soil Loading Rate (GPD/ft ²): _____			
Pipe used: <input type="checkbox"/> Advanced Enviro-Septic®			
Installation Date:		System Startup Date:	
State Permit Number:		Local Construction Permit Number:	
Comments:			