

**3/4 IN. STAINLESS STEEL U-BOLT DETAIL**

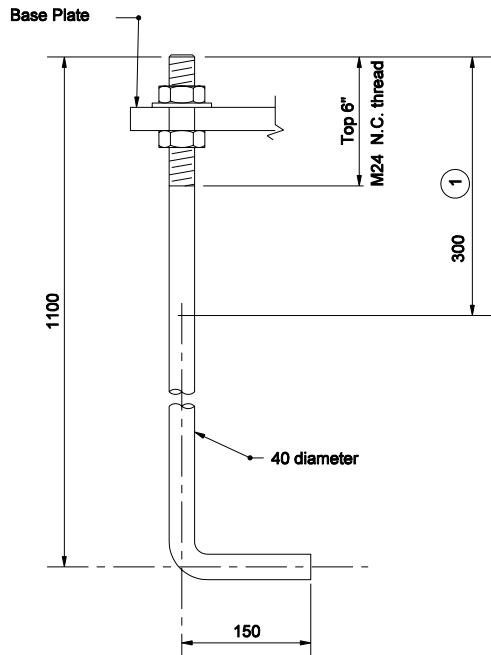

**ANCHOR BOLT DETAIL**

**NOTES:**

- ① After threading, coat or mechanically galvanize as required.

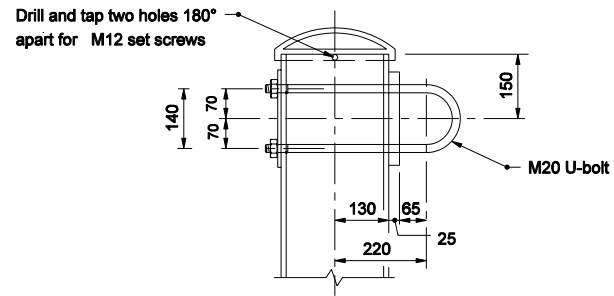

**UPPER CHORD CONNECTION DETAIL**

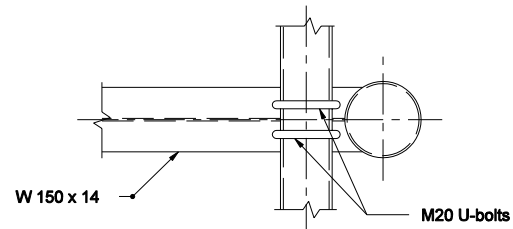

**LOWER CHORD CONNECTION DETAIL**

All Dimension are in mm unless otherwise specified

INDIANA DEPARTMENT OF TRANSPORTATION

ALUMINUM STRUCTURE  
BOLT DETAILS

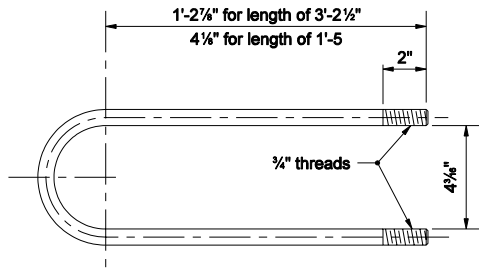

**3/4 IN. STAINLESS STEEL U-BOLT DETAIL**

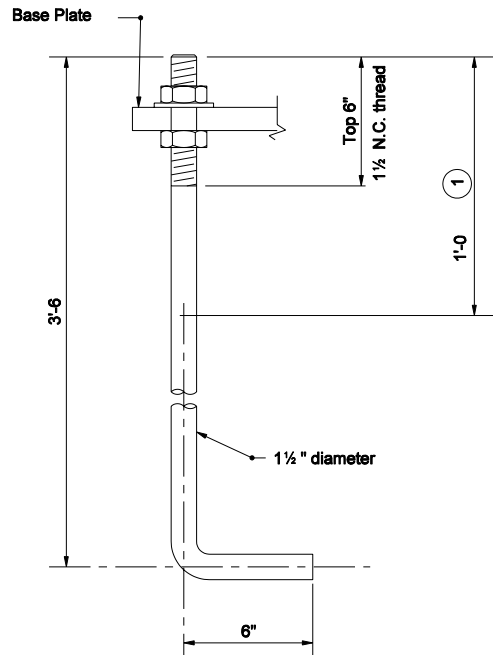

**ANCHOR BOLT DETAIL**

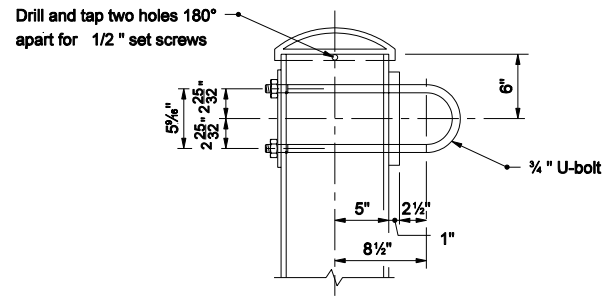

**UPPER CHORD CONNECTION DETAIL**

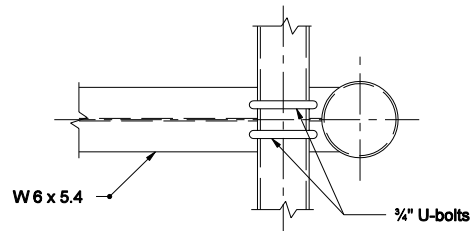

**LOWER CHORD CONNECTION DETAIL**

**NOTES:**

- ① After threading, coat or mechanically galvanize as required.