



APPLICATION FOR VARIANCE

State Form 44400 (R5 / 10-10)

Approved by State Board of Accounts, 2008

INDIANA DEPARTMENT OF HOMELAND SECURITY
 CODE SERVICES SECTION
 402 West Washington Street, Room **E341**
 Indianapolis, IN 46204-2739
http://www.in.gov/dhs/fire/ip_bs_comm_code/



INSTRUCTION: Please refer to the attached four (4) page instructions.
 Attach additional pages as needed to complete this application.

Variance number (Assigned by department)

17-12-08 (a)

1. APPLICANT INFORMATION (Person who would be in violation if variance is not granted; usually this is the owner)

Name of the applicant	Title
Name of organization	Board member
Whispering Knoll School	Telephone number
Address (number and street, city, state, and ZIP code)	(574) 773-0643

2. PERSON SUBMITTING APPLICATION ON BEHALF OF THE APPLICANT (If not submitted by the applicant)

Name of person on behalf of the applicant	Title
Jacob Bepko	agent
Name of organization	Telephone number
Whispering Knoll School	(574) 646-2069
Address (number and street, city, state, and ZIP code)	
8016 750-N ETRA GREEN IN. 46524	

3. DESIGN PROFESSIONAL OF RECORD (If applicable)

Name of design professional	License number
Name of organization	Telephone number
Address (number and street, city, state, and ZIP code)	

4. PROJECT IDENTIFICATION

Name of project	State project number	County
Whispering Knoll School		Marshall
Site address (number and street, city, state, and ZIP code)		

Type of project: New Addition Alteration Change of occupancy Existing

5. REQUIRED ADDITIONAL INFORMATION

The following required information has been included with this application (check as applicable):

- A check made payable to the Indiana Department of Homeland Security for the appropriate amount. (see instructions)
- One (1) set of plans or drawings and supporting data that describe the area affected by the requested variance and any proposed alternatives.
- Written documentation showing that the local fire official has received a copy of the variance application.
- Written documentation showing that the local building official has received a copy of the variance application.

6. VIOLATION INFORMATION

Has the Plan Review Section of the Division of Fire & Building Safety issued a Correction Order?

Yes (if yes, attach a copy of the Correction Order) No

Has a violation been issued? Yes (if yes, attach a copy of the Violation and answer the following) No

Violation issued by: Local Building Department State Fire and Building Code Enforcement Section
 Local Fire Department

7. DESCRIPTION OF REQUESTED VARIANCE

Name of code or standard and edition involved 2008 Indiana Building Code	Specific code section 907.2.3
--	---

Nature of non-compliance (include a description of spaces, equipment, etc. involved as necessary)
 This is a small rural two-room Amish School with an occupant load of less than 70. The manual fire alarm system required by Section 907.2.3 will not be installed.

8. DEMONSTRATION THAT PUBLIC HEALTH, SAFETY, AND WELFARE WILL BE PROTECTED

Select one of the following statements:

- Non-compliance with the rule will not be adverse to the public health, safety or welfare; or
- Applicant will undertake alternative actions in lieu of compliance with the rule to ensure that granting of the variance will not be adverse to public health, safety, or welfare. Explain why alternative actions would be adequate (be specific).

Facts demonstrating that the above selected statement is true:

-Provide interconnected, long life battery smoke and heat detectors throughout building.

9. DEMONSTRATION OF UNDUE HARDSHIP OR HISTORICALLY SIGNIFICANT STRUCTURE

Select at least one of the following statements:

- Imposition of the rule would result in an undue hardship (unusual difficulty) because of physical limitations of the construction site or its utility services.
- Imposition of the rule would result in an undue hardship (unusual difficulty) because of major operational problems in the use of the building or structure.
- Imposition of the rule would result in an undue hardship (unusual difficulty) because of excessive costs of additional or altered construction elements.
- Imposition of the rule would prevent the preservation of an architecturally or a historically significant part of the building or structure.

Facts demonstrating that the above selected statement is true:

This small, two-room school will have a fully operational interconnected smoke and heat detection/alarm system throughout the building. Adequate notice to evacuate the building will be provided via this system. The only difference between the system proposed and the required system is the addition of a manual pull station at the exit doors. Given the small size of the building these pull stations are not necessary.

10. STATEMENT OF ACCURACY

I hereby certify under penalty of perjury that the information contained in this application is accurate.

Signature of applicant or person submitting application <i>Jacob Beechy</i>	Please print name Jacob Beechy	Date of signature (month, day, year) 8-31-2017
Signature of design professional (if applicable)	Please print name	Date of signature (month, day, year)

11. STATEMENT OF AWARENESS (If the application is submitted on the applicant's behalf, the applicant must sign the following statement)

I hereby certify under penalty of perjury that I am aware of this request for variance and that this application is being submitted on my behalf.

Signature of applicant <i>Wayne Schwartz</i>	Please print name Wayne Schwartz	Date of signature (month, day, year) 8-31-2017
---	--	--



APPLICATION FOR VARIANCE

State Form 44400 (R5 / 10-10)

Approved by State Board of Accounts, 2008

INDIANA DEPARTMENT OF HOMELAND SECURITY
CODE SERVICES SECTION
402 West Washington Street, Room E241
Indianapolis, IN 46204-2739
http://www.in.gov/dhs/firefp_bs_comm_code/



INSTRUCTION: Please refer to the attached four (4) page instructions.
Attach additional pages as needed to complete this application.

Variance number (Assigned by department)

17-12-0866

1. APPLICANT INFORMATION (Person who would be in violation if variance is not granted; usually this is the owner)

Name of the applicant	Title
	Board member
Name of organization	Telephone number
Whispering Knoll School	(574) 773-0643
Address (number and street, city, state, and ZIP code)	

2. PERSON SUBMITTING APPLICATION ON BEHALF OF THE APPLICANT (If not submitted by the applicant)

Name of person on behalf of the applicant	Title
Jacob Bepko	Agent
Name of organization	Telephone number
Whispering Knoll School	(574) 646-2067
Address (number and street, city, state, and ZIP code)	
Rt 16 W 750 N ETNA GREEN IN. 46504	

3. DESIGN PROFESSIONAL OF RECORD (If applicable)

Name of design professional	License number
Name of organization	Telephone number
	()
Address (number and street, city, state, and ZIP code)	

4. PROJECT IDENTIFICATION

Name of project	State project number	County
Whispering Knoll School		Marshall
Site address (number and street, city, state, and ZIP code)		

Type of project: New Addition Alteration Change of occupancy Existing

5. REQUIRED ADDITIONAL INFORMATION

The following required information has been included with this application (check as applicable):

- A check made payable to the Indiana Department of Homeland Security for the appropriate amount. (see instructions)
- One (1) set of plans or drawings and supporting data that describe the area affected by the requested variance and any proposed alternatives.
- Written documentation showing that the local fire official has received a copy of the variance application.
- Written documentation showing that the local building official has received a copy of the variance application.

6. VIOLATION INFORMATION

Has the Plan Review Section of the Division of Fire & Building Safety issued a Correction Order?

Yes (if yes, attach a copy of the Correction Order) No

Has a violation been issued? Yes (if yes, attach a copy of the Violation and answer the following) No

Violation issued by: Local Building Department State Fire and Building Code Enforcement Section
 Local Fire Department

7. DESCRIPTION OF REQUESTED VARIANCE

Name of code or standard and edition involved 2014 Indiana Building Code	Specific code section 1011.3
--	--

Nature of non-compliance (include a description of spaces, equipment, etc. involved as necessary)
This is a rural, two-room Amish school without electricity. The electrically powered illumination of the exit signs will not be provided.

8. DEMONSTRATION THAT PUBLIC HEALTH, SAFETY, AND WELFARE WILL BE PROTECTED

Select one of the following statements:

- Non-compliance with the rule will not be adverse to the public health, safety or welfare; or
- Applicant will undertake alternative actions in lieu of compliance with the rule to ensure that granting of the variance will not be adverse to public health, safety, or welfare. Explain why alternative actions would be adequate (be specific).

Facts demonstrating that the above selected statement is true:

Highly reflective, photo-luminescent exit signs will be provided at all exit doors.
There will be hard-piped L.P. gas lights or Coleman lanterns or Leacock lights installed for lighting.

9. DEMONSTRATION OF UNDUE HARDSHIP OR HISTORICALLY SIGNIFICANT STRUCTURE

Select at least one of the following statements:

- Imposition of the rule would result in an undue hardship (unusual difficulty) because of physical limitations of the construction site or its utility services.
- Imposition of the rule would result in an undue hardship (unusual difficulty) because of major operational problems in the use of the building or structure.
- Imposition of the rule would result in an undue hardship (unusual difficulty) because of excessive costs of additional or altered construction elements.
- Imposition of the rule would prevent the preservation of an architecturally or a historically significant part of the building or structure.

Facts demonstrating that the above selected statement is true:

This rural Amish school is not served with electricity to power the exit sign lighting. There will be hard-piped L.P. gas lights or Coleman lanterns or Leacock lights installed for lighting.

10. STATEMENT OF ACCURACY

I hereby certify under penalty of perjury that the information contained in this application is accurate.

Signature of applicant or person submitting application <i>Jacob Beechy</i>	Please print name Jacob Beechy	Date of signature (month, day, year) 8-31-2017
Signature of design professional (if applicable)	Please print name	Date of signature (month, day, year)

11. STATEMENT OF AWARENESS (If the application is submitted on the applicant's behalf, the applicant must sign the following statement)

I hereby certify under penalty of perjury that I am aware of this request for variance and that this application is being submitted on my behalf.

Signature of applicant <i>Wayne Schwartz</i>	Please print name Wayne Schwartz	Date of signature (month, day, year) 8-31-2017
---	--	--



APPLICATION FOR VARIANCE

State Form 44400 (R5 / 10-10)

Approved by State Board of Accounts, 2008

INDIANA DEPARTMENT OF HOMELAND SECURITY
 CODE SERVICES SECTION
 402 West Washington Street, Room E241
 Indianapolis, IN 46204-2739
http://www.in.gov/dhs/fire/ip_bs_comm_code/



INSTRUCTION: Please refer to the attached four (4) page instructions.
 Attach additional pages as needed to complete this application.

Variance number (Assigned by department)
 17-12-08 (4)

1. APPLICANT INFORMATION (Person who would be in violation if variance is not granted; usually this is the owner)

Name of the applicant	Title
Name of organization	Board member
Whispering Knoll School	Telephone number
Address (number and street, city, state, and ZIP code)	(574) 773-0643

2. PERSON SUBMITTING APPLICATION ON BEHALF OF THE APPLICANT (If not submitted by the applicant)

Name of person on behalf of the applicant	Title
Jacob Bepko	Agent
Name of organization	Telephone number
Whispering Knoll School	(574) 646-2069
Address (number and street, city, state, and ZIP code)	
701 W 750-N ETNA GREEN IN 46504	

3. DESIGN PROFESSIONAL OF RECORD (If applicable)

Name of design professional	License number
Name of organization	Telephone number
Address (number and street, city, state, and ZIP code)	

4. PROJECT IDENTIFICATION

Name of project	State project number	County
Whispering Knoll School		Marshall
Site address (number and street, city, state, and ZIP code)		

Type of project: New Addition Alteration Change of occupancy Existing

5. REQUIRED ADDITIONAL INFORMATION

The following required information has been included with this application (check as applicable):

- A check made payable to the Indiana Department of Homeland Security for the appropriate amount. (see instructions)
- One (1) set of plans or drawings and supporting data that describe the area affected by the requested variance and any proposed alternatives.
- Written documentation showing that the local fire official has received a copy of the variance application.
- Written documentation showing that the local building official has received a copy of the variance application.

6. VIOLATION INFORMATION

Has the Plan Review Section of the Division of Fire & Building Safety issued a Correction Order?
 Yes (if yes, attach a copy of the Correction Order) No

Has a violation been issued? Yes (if yes, attach a copy of the Violation and answer the following) No

Violation issued by: Local Building Department State Fire and Building Code Enforcement Section
 Local Fire Department

7. DESCRIPTION OF REQUESTED VARIANCE

Name of code or standard and edition involved

2008 Indiana Building Code

Specific code section

1006

Nature of non-compliance (include a description of spaces, equipment, etc. involved as necessary)

This is a small rural Amish school. Means of egress illumination required by Section 1006 will not be installed.

8. DEMONSTRATION THAT PUBLIC HEALTH, SAFETY, AND WELFARE WILL BE PROTECTED

Select one of the following statements:

- Non-compliance with the rule will not be adverse to the public health, safety or welfare; or
- Applicant will undertake alternative actions in lieu of compliance with the rule to ensure that granting of the variance will not be adverse to public health, safety, or welfare. Explain why alternative actions would be adequate (be specific).

Facts demonstrating that the above selected statement is true:

-For the safety of the children, travel to and from these schools is accomplished during daylight hours. Because of this, the school building will not be used during non-daylight hours.
-Highly reflective photo luminescent exit signs will be installed at each exit door.
-An interconnected smoke and heat detection/alarm system will be installed throughout the building.

9. DEMONSTRATION OF UNDUHARDSHIP OR HISTORICALLY SIGNIFICANT STRUCTURE

Select at least one of the following statements:

- Imposition of the rule would result in an undue hardship (unusual difficulty) because of physical limitations of the construction site or its utility services.
- Imposition of the rule would result in an undue hardship (unusual difficulty) because of major operational problems in the use of the building or structure.
- Imposition of the rule would result in an undue hardship (unusual difficulty) because of excessive costs of additional or altered construction elements.
- Imposition of the rule would prevent the preservation of an architecturally or a historically significant part of the building or structure.

Facts demonstrating that the above selected statement is true:

This rural Amish school is not served with electricity to power the emergency lighting.

10. STATEMENT OF ACCURACY

I hereby certify under penalty of perjury that the information contained in this application is accurate.

Signature of applicant or person submitting application

Please print name

Date of signature (month, day, year)

Jacob Beecher

Jacob Beecher

8-31-2017

Signature of design professional (if applicable)

Please print name

Date of signature (month, day, year)

11. STATEMENT OF AWARENESS (If the application is submitted on the applicant's behalf, the applicant must sign the following statement)

I hereby certify under penalty of perjury that I am aware of this request for variance and that this application is being submitted on my behalf.

Signature of applicant

Please print name

Date of signature (month, day, year)

Wayne Schwartz

Wayne Schwartz

8-31-2017



APPLICATION FOR VARIANCE

State Form 44400 (R5 / 10-10)

Approved by State Board of Accounts, 2008

INDIANA DEPARTMENT OF HOMELAND SECURITY
 CODE SERVICES SECTION
 402 West Washington Street, Room E241
 Indianapolis, IN 46204-2739
http://www.in.gov/dhs/fire/fp_bs_comm_code/



INSTRUCTION: Please refer to the attached four (4) page instructions.
 Attach additional pages as needed to complete this application.

Variance number (Assigned by department)

17-12-08(d)

1. APPLICANT INFORMATION (Person who would be in violation if variance is not granted; usually this is the owner)

Name of the applicant	Title
	Board member
Name of organization	Telephone number
Whispering Knoll School	(574) 773-0643
Address (number and street, city, state, and ZIP code)	

2. PERSON SUBMITTING APPLICATION ON BEHALF OF THE APPLICANT (If not submitted by the applicant)

Name of person on behalf of the applicant	Title
Jacob Beechy	agent
Name of organization	Telephone number
Whispering Knoll School	(574) 646-2069
Address (number and street, city, state, and ZIP code)	
8016 750-N Etna Green IN 46524	

3. DESIGN PROFESSIONAL OF RECORD (If applicable)

Name of design professional	License number
Name of organization	Telephone number
	()
Address (number and street, city, state, and ZIP code)	

4. PROJECT IDENTIFICATION

Name of project	State project number	County
Whispering Knoll School		Marshall
Site address (number and street, city, state, and ZIP code)		

Type of project: New Addition Alteration Change of occupancy Existing

5. REQUIRED ADDITIONAL INFORMATION

The following required information has been included with this application (check as applicable):

- A check made payable to the Indiana Department of Homeland Security for the appropriate amount. (see instructions)
- One (1) set of plans or drawings and supporting data that describe the area affected by the requested variance and any proposed alternatives.
- Written documentation showing that the local fire official has received a copy of the variance application.
- Written documentation showing that the local building official has received a copy of the variance application.

6. VIOLATION INFORMATION

Has the Plan Review Section of the Division of Fire & Building Safety issued a Correction Order?

Yes (if yes, attach a copy of the Correction Order) No

Has a violation been issued? Yes (if yes, attach a copy of the Violation and answer the following) No

Violation issued by: Local Building Department State Fire and Building Code Enforcement Section
 Local Fire Department

7. DESCRIPTION OF REQUESTED VARIANCE

Name of code or standard and edition involved

2014 Indiana Building Code

Specific code section

903.2.7

Nature of non-compliance (include a description of spaces, equipment, etc. involved as necessary)

This is a mixed use E/R-3 occupancy building. The automatic sprinkler system required by IBC 903.2.7 will not be installed in this building.

8. DEMONSTRATION THAT PUBLIC HEALTH, SAFETY, AND WELFARE WILL BE PROTECTED

Select one of the following statements:

- Non-compliance with the rule will not be adverse to the public health, safety or welfare; or
- Applicant will undertake alternative actions in lieu of compliance with the rule to ensure that granting of the variance will not be adverse to public health, safety, or welfare. Explain why alternative actions would be adequate (be specific).

Facts demonstrating that the above selected statement is true:

This is a one room school with a classroom occupant load of less than 50 and a single occupant studio type apartment for the teacher to use during the school week. In addition to those items required by code, the following will be installed:

1. A long-life battery operated smoke and heat detection system with interconnected alarms will be installed throughout the building.
 2. A second exit door from the classroom area will be installed.
 3. Highly reflective exit signs will be at all interior and exterior exit doors.
- In addition, there will be no open flames allowed in the classroom area.

9. DEMONSTRATION OF UNDUE HARDSHIP OR HISTORICALLY SIGNIFICANT STRUCTURE

Select at least one of the following statements:

- Imposition of the rule would result in an undue hardship (unusual difficulty) because of physical limitations of the construction site or its utility services.
- Imposition of the rule would result in an undue hardship (unusual difficulty) because of major operational problems in the use of the building or structure.
- Imposition of the rule would result in an undue hardship (unusual difficulty) because of excessive costs of additional or altered construction elements.
- Imposition of the rule would prevent the preservation of an architecturally or a historically significant part of the building or structure.

Facts demonstrating that the above selected statement is true:

- This is a mixed use private Amish school with the following constraints:
1. This school is in a rural location with no readily available source of water for the sprinkler system.
 2. Excessive costs would be incurred to install an oversize well, storage tanks and a dry pipe system to install sprinklers for a single efficiency apartment.
 3. An electric well pump would be required on a property not served by commercial electricity.
 4. Any attempt to provide separation between the E and R-3 would not be desirable or practical for the use of the building.

10. STATEMENT OF ACCURACY

I hereby certify under penalty of perjury that the information contained in this application is accurate.

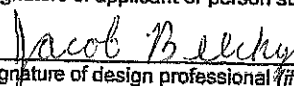
Signature of applicant or person submitting application	Please print name	Date of signature (month, day, year)
	Jacob Beechy	8-31-2017
Signature of design professional (if applicable)	Please print name	Date of signature (month, day, year)

11. STATEMENT OF AWARENESS (If the application is submitted on the applicant's behalf, the applicant must sign the following statement)

I hereby certify under penalty of perjury that I am aware of this request for variance and that this application is being submitted on my behalf.

Signature of applicant	Please print name	Date of signature (month, day, year)
	Wayne Schwartz	8-31-2017

Whispering Knoll School

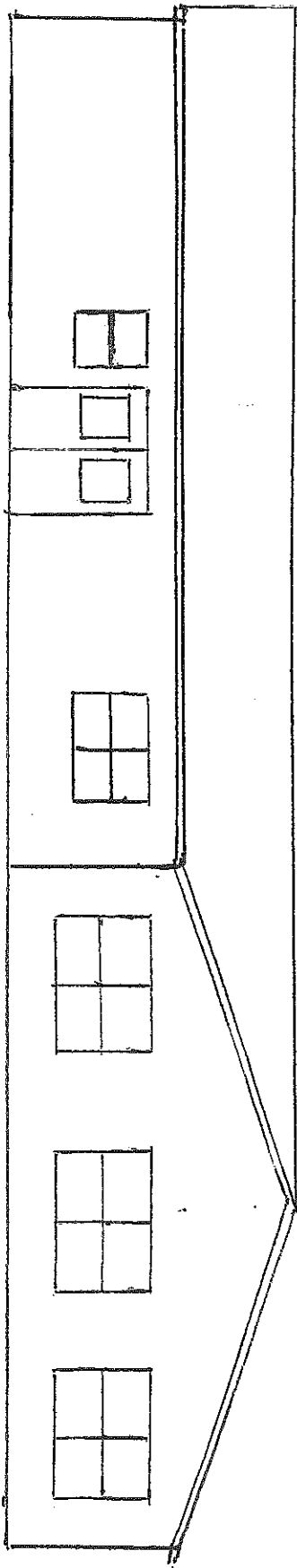

East Elevation

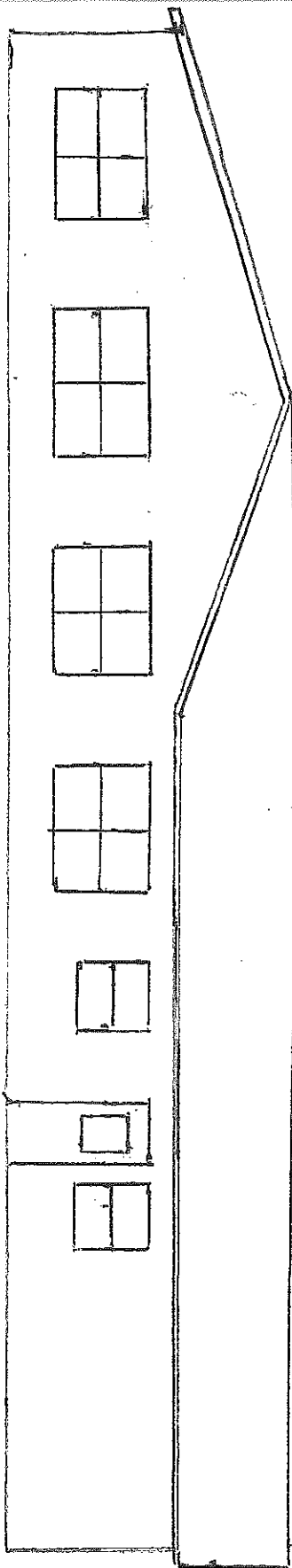

West Elevation

Whispering Knoll School

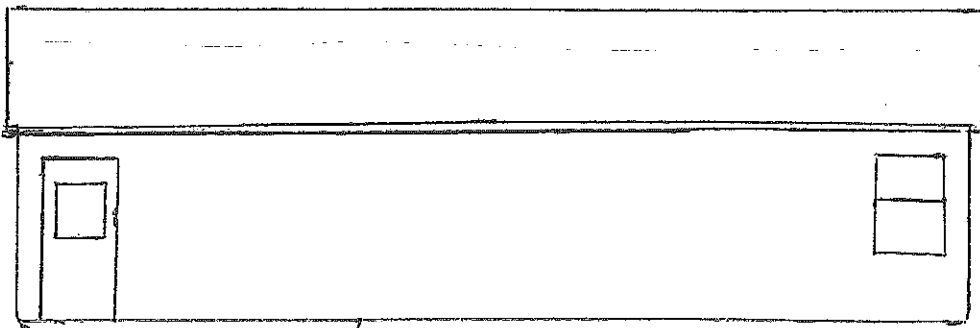

North Elevation

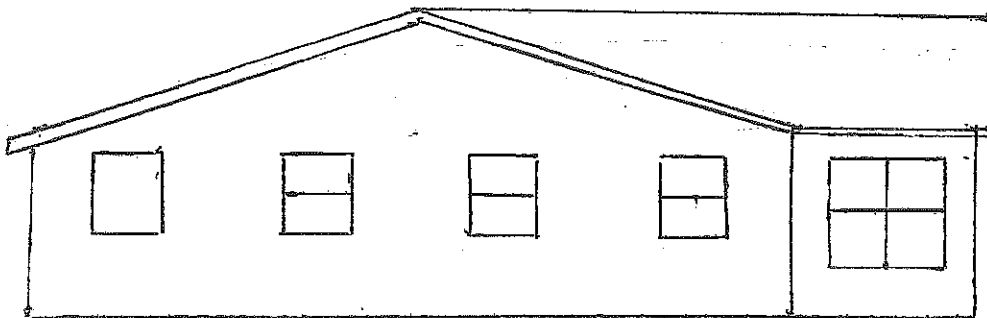

South Elevation

Whispering Knoll School

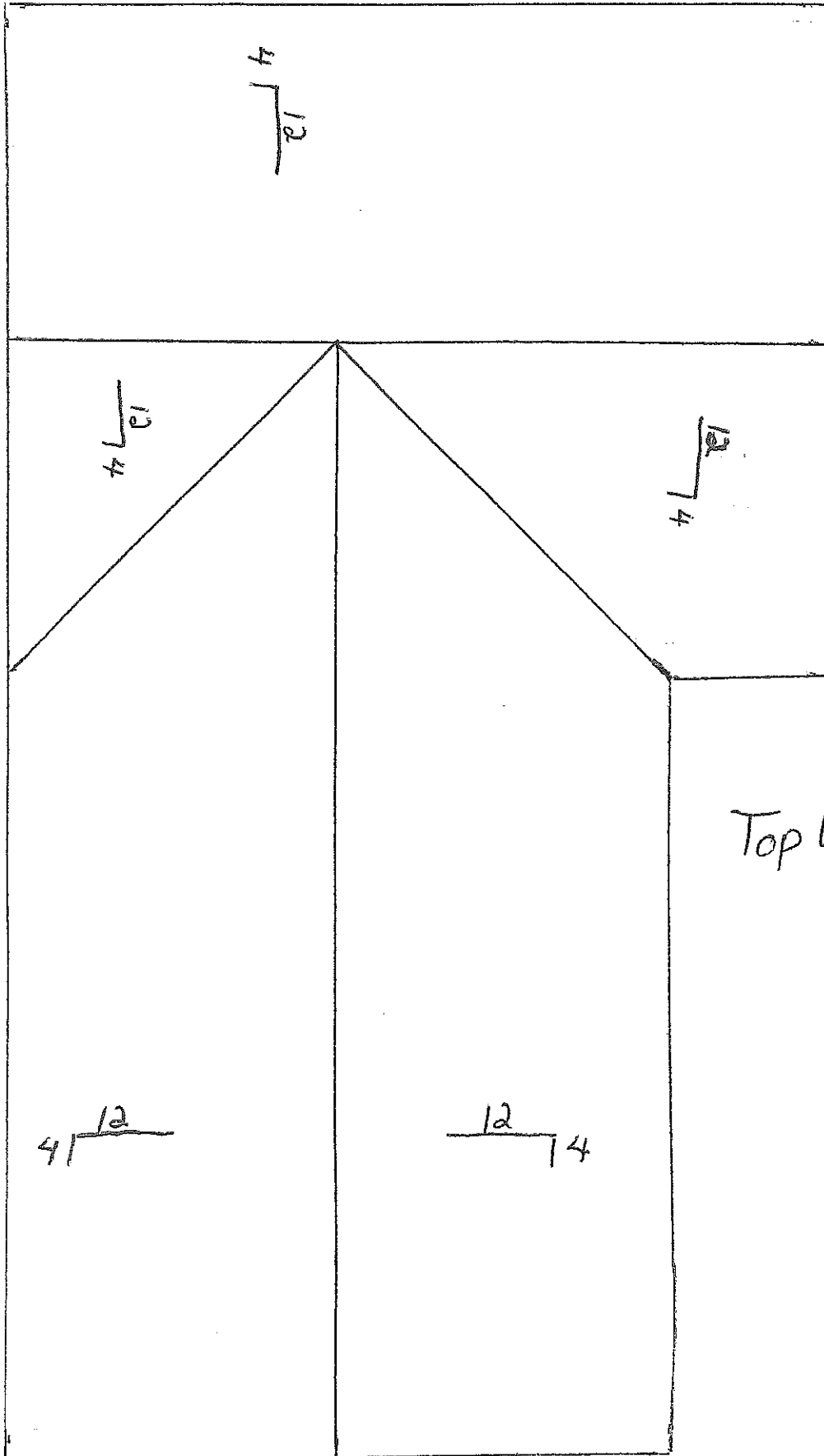
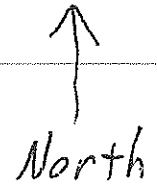

Top View

North ↑ Whispering Knoll

40'

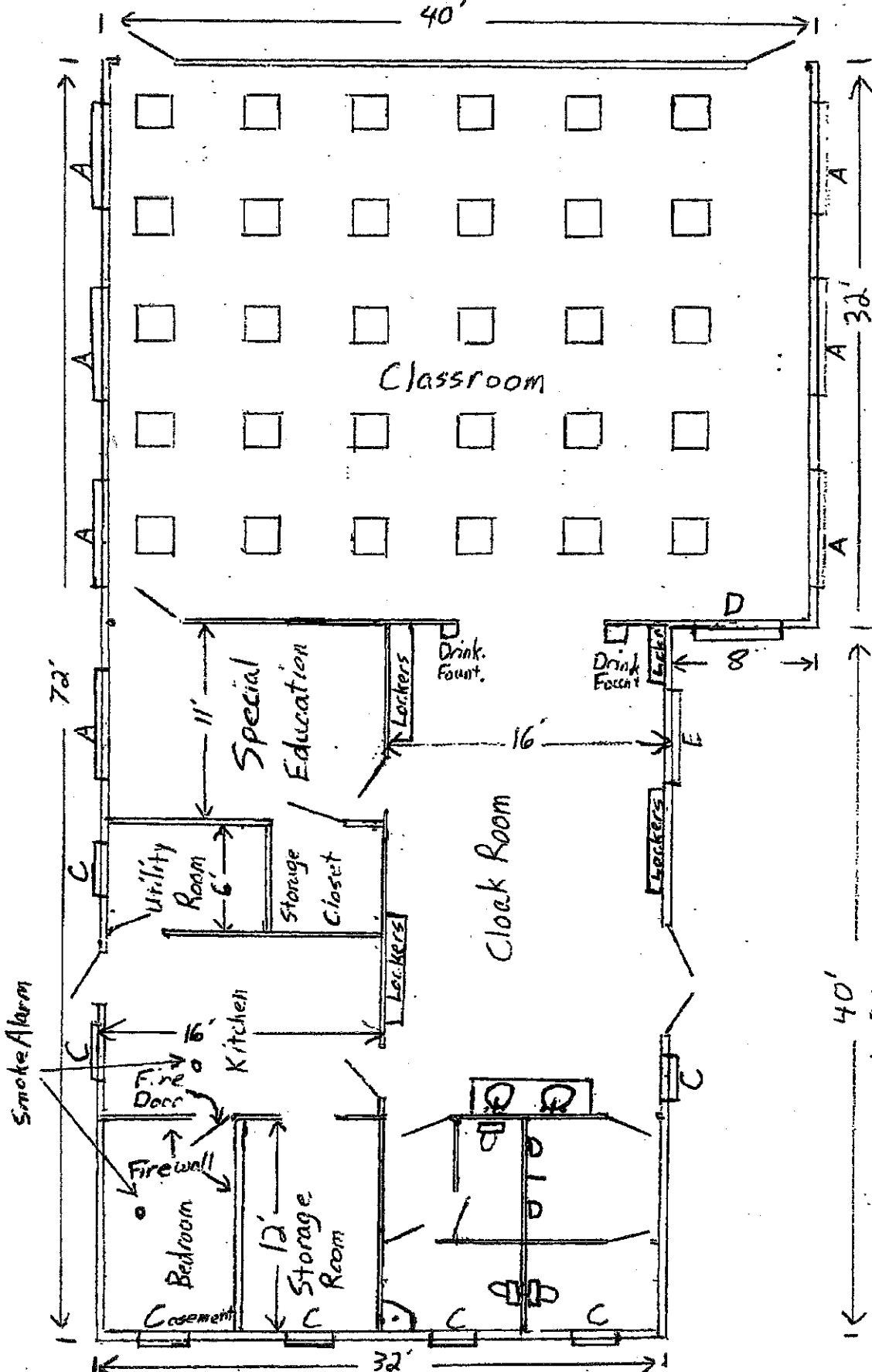

Windows

- A=6'4" x 4'4"
- B=3'2" x 4'4"
- C=2'8" x 3'6"
- D=5' x 4'4"
- E=5' x 3'6"

40'

32'

72'

Whispering Knoll School

Foundation Plan

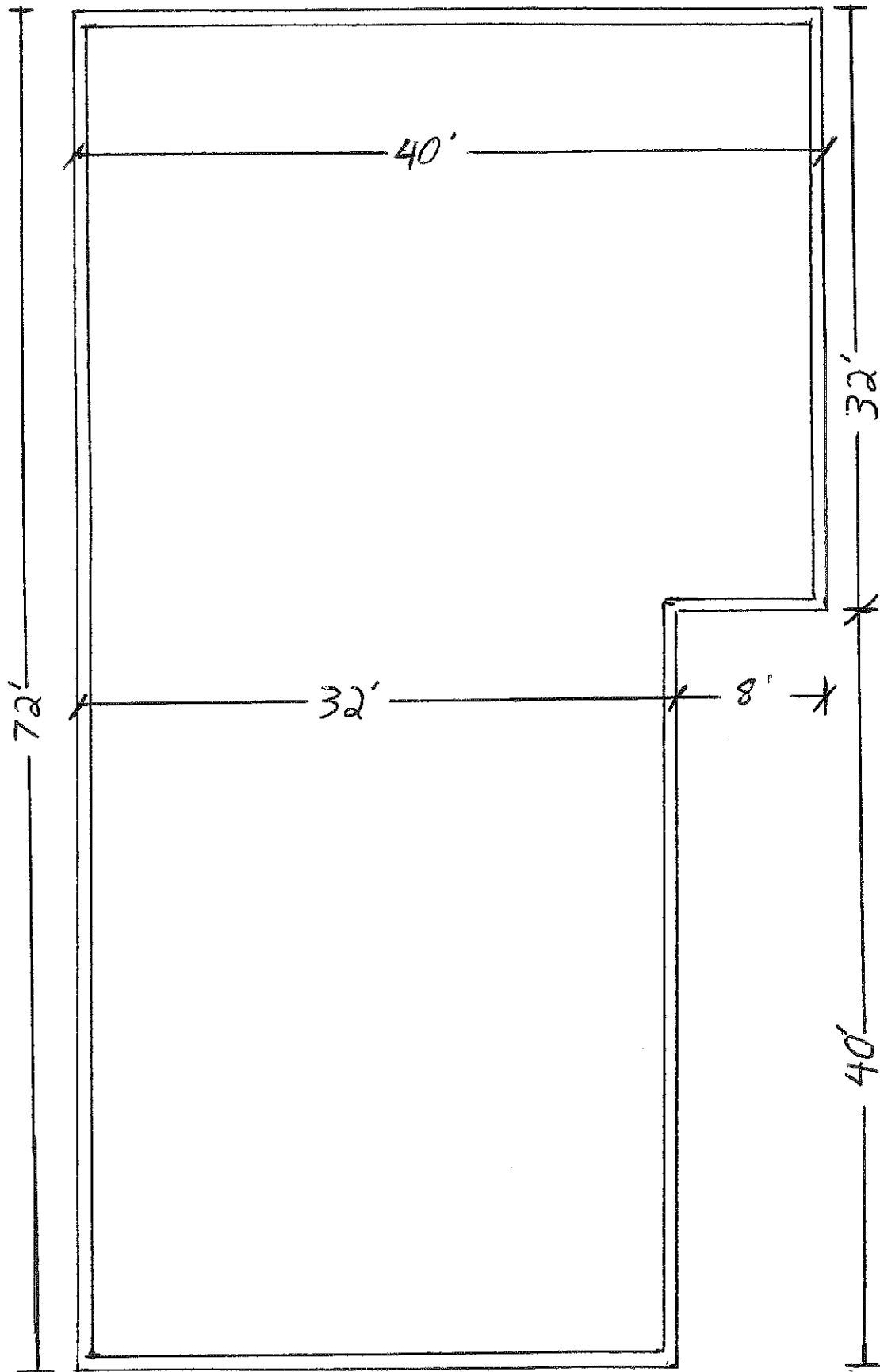

Whispering Knoll School

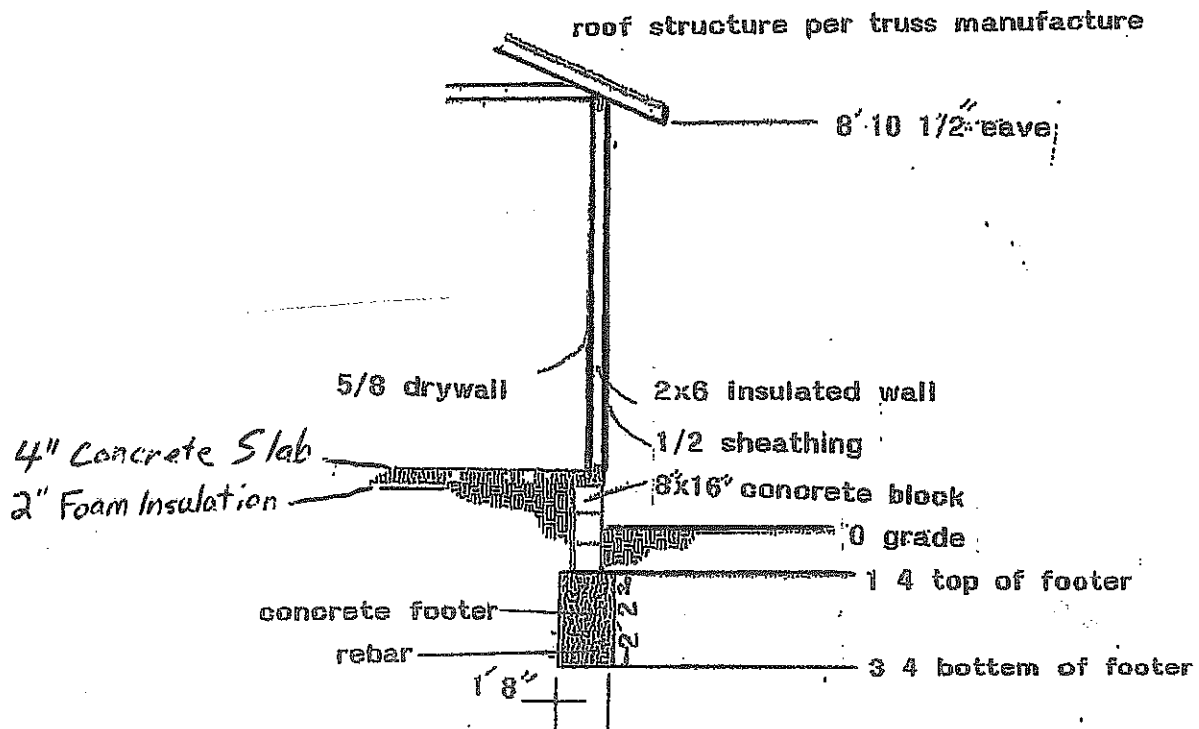

5/8 drywall 2 sides extending to roof line

firewall at bedroom storage room separation

Firewall At Bedroom-Kitchen Separation

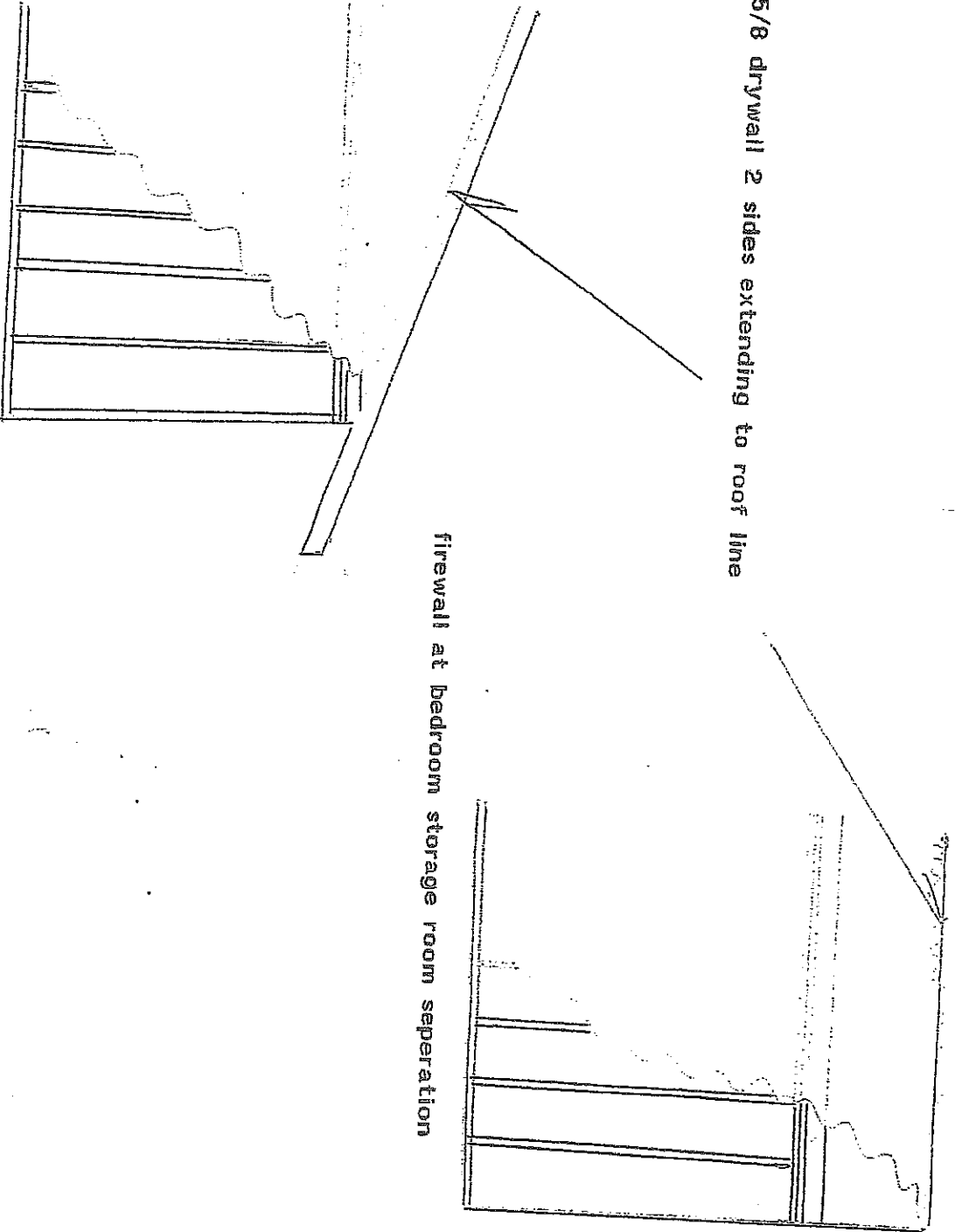



SCHROCK PLUMBING, INC

Menno Schrock (License #PC89200011) • Nathan Schrock (License #PC10400543)

Ph. 574-773-4194

30951 County Road 50 • Nappanee IN 46550

Whispering Knoll School

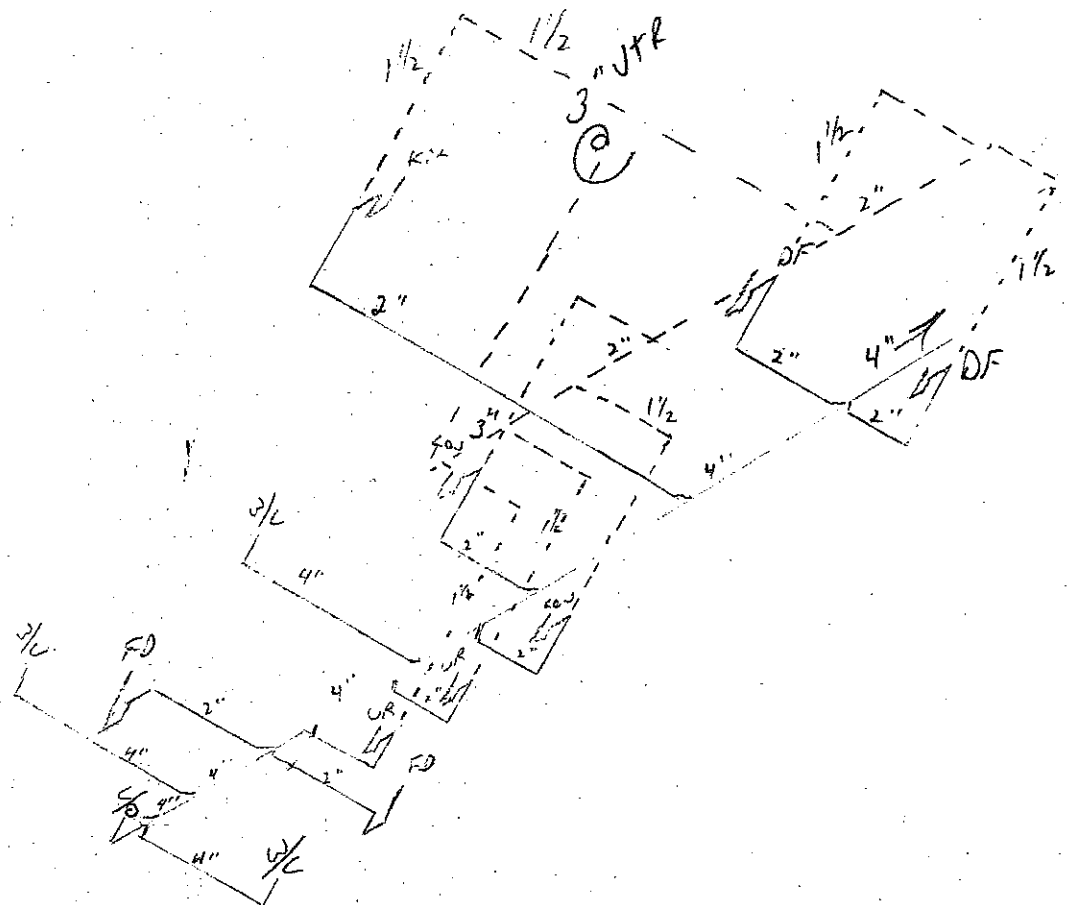

STRUCTURAL RENEWAL

	Document Title:	Doc No:	FRM B1-02	
	Structural Performance Certification Authorization Report	Rev No: 6	Page: 1	Of: 1
Required By: PRO B1-03				

CAR & Product ID Number: 112 - 416.0
 Issue Date: 7/31/2008
 Revision Date: 7/10/2014
 Expiration Date: 7/18/2018
 Company Code: 112

This Certification Authorization Report (CAR) is issued by Keystone Certifications, Inc. (KCI) after full validation review of the product qualification documents for the product named below. This report is only valid when signed by an officer of KCI, and indicates the product as manufactured by the company named below has been tested and meets the requirements of the referenced standard and is eligible for the application of Keystone Certification Program certification labels. Licensee stipulates in affixing certification labels to products, that those products are representative of the specimen evaluated and documented for certification authorization. Only products bearing such a certification label shall be considered certified. The information in this report can be verified at www.keystonecerts.com.

Licensee Information:	Product Information:
American Window Alliance 1239 Erie Street North Kansas City MO 64116	Model: Windgate/Belmont Equal Lite Double Hung Operator Type: H Config: EM/IM Max Width: 48 Max Height: 72

Referenced Standard:	Product Rating:
AAMA/WDMA/CSA 101/IS2/A440-05	H-R15 1219x1829 (48x72)

Qualifying Test Information:	
Test Report No:	ATI-80489.02-501-47-R1
Test Report Expiration:	7/18/2018

Authorized Signature:



Digitally signed by Steven M. Ulrich
 DN: cn=Steven M. Ulrich,
 o=Keystone Certifications, Inc., ou,
 email=sulrich@keystonecerts.com,
 c=US
 Date: 2014.07.15 11:25:48 -04'00'

Keystone Certifications, Inc.

564 Old York Road, Suite 5
 Eiters, Pennsylvania 17319
 Phone: 717-932-8500
 Fax: 717-932-8501

THERMAL PERFORMANCE RENEWAL



KEYSTONE CERTIFICATIONS, INC.
564 OLD YORK ROAD, SUITE 5
ETTERS, PA 17319 / PHONE 717-932-8500

Notice of Product Certification Authorization National Fenestration Rating Council

Issued To:

Manufacturer: American Window Alliance
Address: 1600 North Jackson Avenue
Kansas City MO 64120
Man'f Code AMW
Cert Date: 7/23/2002

Certification Number

1618

Product Line Number

AMW - K - 006

Revision Date

12/16/2015

The Following NFRC Product Line Has Been Authorized For Certification:

Model / Series: Windgate/Belmont/Stormgate/Hawthorne Double Hung
Operator Type: VSDH
Frame Type: VY,VF
Sash Type: VI,VA,VP
Exp. Date: 12/14/2018

Ratings Authorized For Certification:

Rating	Property	Authorized
NFRC 100	U-factor	<input checked="" type="checkbox"/>
NFRC 200	Solar Heat Gain Coefficient	<input checked="" type="checkbox"/>
NFRC 200	Visible Light	<input checked="" type="checkbox"/>
NFRC 400	Air Leakage	<input checked="" type="checkbox"/>
NFRC 500	Condensation Resistance	<input checked="" type="checkbox"/>

Fenestration products are not NFRC Certified unless manufactured and labeled in accordance with the current version of NFRC-700, Product Certification Program requirements.

*This is a cover sheet for an NFRC Certification Authorization Report (CAR)
the corresponding CAR may be downloaded for printing at www.nfrc.org.*

The Manufacturer is authorized to label the options listed in the corresponding CAR

Please notify Keystone of any errors or omissions within 10 days of receipt.

Due diligence was used in authorizing these products for certification. By accepting this report the licensee agrees to hold harmless and indemnify Keystone Certifications, Inc. from all claims or liabilities which may arise based on this certification authorization. Certification authorization is based on NFRC program requirements and simulation and test reports from accredited laboratories.



*Bremen Volunteer
Fire Department*

123 S. Center St. • Bremen, Indiana 46506 •

September 14, 2017

To whom it may concern:

I received a copy of the variances in the attached pages for the Whispering Knoll School.

If you have any questions or concerns, please feel free to give me a call.

Thank You

A handwritten signature in cursive script that reads "Matt Neher".

Matt Neher
Fire Chief
Bremen Fire Department
123 S Center Street
Bremen, IN 46506
Phone #: (574) 546-3660

BREMEN FIRE STATION

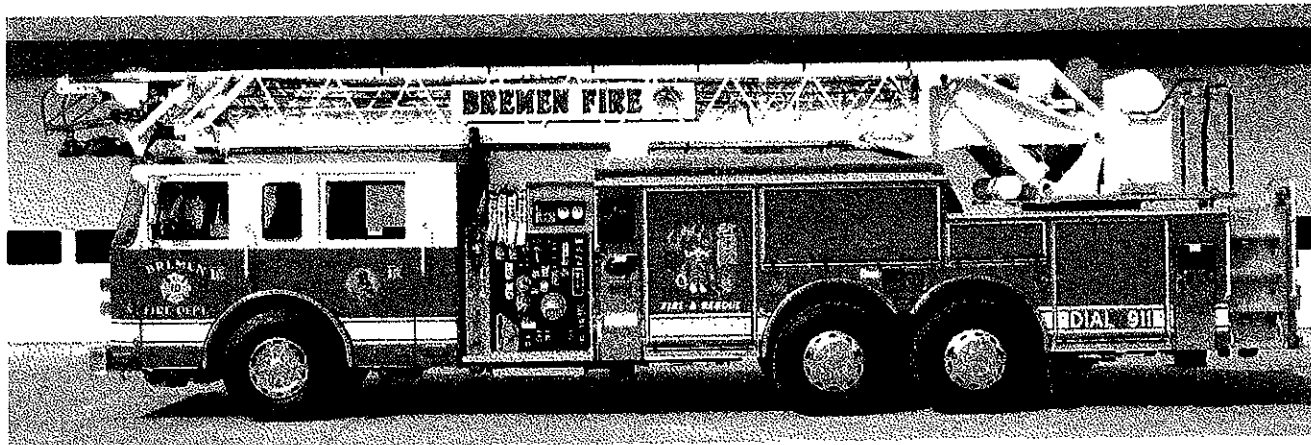

DIRECT NUMBER: (574) 546-3660
CELL NUMBER: (574) 527-9001
FAX: (574) 546-5223

FAX Communication Cover Letter

Confidential - Eyes Only Addressee

To:	<u>Jake Beechy</u>	Date:	<u>9/14/2017</u>
Fax#:	<u>(574) 646-2098</u>	Time:	<u>11:00 PM</u>
From:	<u>Matthew Neher</u>	Total Pages:	<u>2</u>
Department:	<u></u>		(Including Cover)

Message: Letter of variance.

Handling Instructions:
 High Priority - Deliver Immediately
 If you do not receive all the pages, please call back as soon as possible.



Marshall County Building Department

Chuck DeWitt, Building Commissioner

112 W. Jefferson Room 302

Plymouth, IN 46563

574-935-8531

September 18, 2017

To Whom It May Concern,

I have received a copy of the Application for Variance for not installing sprinklers, manual fire alarms, making exit lighting modifications and elimination of vestibule requirements to Whispering Knoll School.

Respectfully,

A handwritten signature in cursive script that reads 'Chuck DeWitt'.

Chuck DeWitt
Marshall County Building Commissioner



Borkholder Buildings and Supply

P.O. Box 32 U.S. 6 West
Nappanee, IN 46550
Phone: (574) 773-3144 Fax: (574) 773-2897

DATE: 8/11/17

Quote ID	Account ID	Salesperson	Designer	Order Date	Required Date	Shipped Date	Ship Via
B081701547		Arlin	AS	//	//	//	

Bill To: Hastings
(574) 930-6490

Ship To:

Job Name: Whispering Knoll School
Lot # SUBDIV:

NOTES:
Quote is good for only 15 DAYS and subject to Borkholders terms and conditions. Refer to WTCA 4-2002 for Design Responsibilities. Wood truss quote only. No hand framing or bracing included.

ROOF TRUSSES

PROFILE	QTY PLY	PITCH		TYPE ID	SPAN	LOAD Spacing	LUMBER		OVERHANG		CANTILEVER		STUB	
		TOP	BOT				TOP	BOT	LEFT	RIGHT	LEFT	RIGHT	LEFT	RIGHT
	1	4.00	2.00	GABLE S01	32-00-00	50.0 24"	2 X 6	2 X 4	01-00-00	01-00-00				
	3	4.00	2.00	SCISSOR S02	32-00-00	50.0 24"	2 X 6	2 X 4	01-00-00	01-00-00				
	16	4.00	2.00	SCISSORS S03	32-00-00	50.0 24"	2 X 6	2 X 4	01-00-00					
	1	4.00	2.00	GABLE S04	32-00-00	50.0 24"	2 X 6	2 X 4	01-00-00					
	1	4.00	0.00	GABLE T01	32-00-00	50.0 24"	2 X 6	2 X 4	01-00-00	01-00-00				
	20	4.00	0.00	COMMON T02	32-00-00	50.0 24"	2 X 6	2 X 4	01-00-00	01-00-00				

ITEMS

QTY	ITEM TYPE	DESCRIPTION	LENGTH FT-IN-10	NOTES
1	Miscellaneous	Layout		
1	Miscellaneous	Truss Packet		

ACCEPTED BY SELLER	ACCEPTED BY BUYER	SUB-TOTAL	\$4,986.25
		DISCOUNT	\$879.52
BY: _____	PURCHASER: _____	SUB-TOTAL	\$4,106.73
TITLE: _____	BY: _____ TITLE: _____	DELIVERY	\$50.00
DATE OF ACCEPTANCE: _____	ADDRESS: _____	SUB-TOTAL	\$4,156.73
	PHONE: _____ DATE: _____	SALES TAX 7.000%	\$290.97
		GRAND TOTAL	\$4,447.70
		3% Net 10 days	\$123.20
		Total:	\$4,324.50

Thank you for your order.

Job B091701547	Truss Tr2	Truss Type Common	Qty 20	Ply 1	Hastings-Whispering Knoll School
Berkholder Building & Supply, Napponee, IN 46554 AS					Job Reference (optional) B-100-Msr 02017 Mitak Industries, Inc. Fr Aug 11 10:32:43 2017 Page 1
ID:9eeeb71dXRf7E2N0VHAdyp_8f470duLGrZDl6faNNZTYqDxLIDNRBDdK_ArdwGyoyvo					

-1-0-00-0-0
1-0-0
64-8
8-4-8
7-7-8
18-0-0
7-7-8
23-7-8
8-4-8
32-0-0 33-0-0
(1-0-0)
Scale = 1:88.5

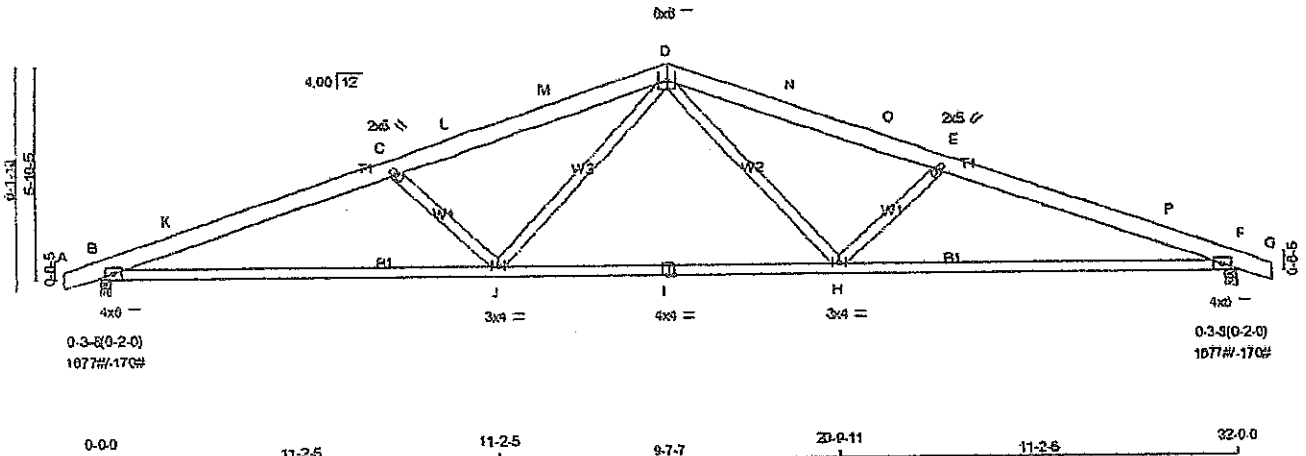

LOADING (psf)	SPACING	CSL	DEFL	PLATES	GRIP
TCLL (roof) 30.0	2-0-0	TC 0.53	in (loc) 1/del 1/d	MT20	244/190
Snow (Plf) 25.4/30.0	Plate Grip DOL 1.15	BC 0.95	Ver(TL) -0.36 F-H >=23 240		
TCOL 10.0	Lumber DOL 1.15	WB 0.24	Ver(TL) -0.97 F-H >=23 180		
BCLL 0.0	Rep Stress Incr YES	Matrix-S	Horz(TL) 0.17 F n/a w/s		
BCOL 10.0	Code IBC2012/TP12007			Weight 164 lb	FT = 20%

LUMBER-
 TOP CHORD 2x6 SP No.1
 BOT CHORD 2x4 SP No.1
 WEBS 2x4 SP No.2

BRACING-
 TOP CHORD Structural wood sheathing directly applied or 3-4-5 oc purlins.
 BOT CHORD Rigid purlin directly applied or 2-2-0 ceiling.

Mitak recommends that Stabilizers and required cross bracing be installed during truss erection, in accordance with Stabilizer Installation Guide.

REACTIONS: (b/size) B=1521/0-3-8 (min. 0-2-0), F=1521/0-3-8 (min. 0-2-0)
 Max: Horz B=50(LC 14)
 Max: Uplift B=170(LC 16), F=170(LC 16)
 Max: Grav B=1677(LC 2), F=1677(LC 2)

FORCES: (lb) - Max. Comp./Max. Ten. - All forces 250 (lb) or less except when shown.
 TOP CHORD B-K=-3708/449, C-K=-3041/473, C-L=-3190/370, L-M=-3087/383, D-M=-3079/336, D-N=-3079/397, N-O=-3087/283, E-O=-3160/370
 E-P=-3041/473, F-P=-3708/449
 BOT CHORD B-J=-375/2430, L-J=-181/2318, H-J=-181/2318, F-H=-280/2430
 WEBS O-H=-45/301, E-H=-731/234, D-J=-45/301, C-J=-731/234

NOTES-
 1) Unbalanced roof live loads have been considered for this design.
 2) Wind: ASCE 7-10: V=120mph (3-second gust) V=95mph: TCOL=6.0psf; BCOL=6.0psf; h=20ft; E=45ft; L=32ft; eave=4ft; Cat. III; Exp. C, enclosed; MWFRS (directional) and C-C Exterior(2) -1.0-0 to 2-2-0, Interior(1) 2-2-0 to 10-0-0, Exterior(2) 10-0-0 to 10-2-8 zone; cantilever left and right exposed; end vertical left and right exposed C-C for members and forces & MWFRS for reactions shown; Lumber DOL=1.60 plate grip DOL=1.60
 3) TCLL: ASCE 7-10: Pr=30.0 psf (roof live load); Lumber DOL=1.15 Plate DOL=1.15; Pp=24.0 psf (ground snow); Pl=25.4 psf (flat roof snow); Lumber DOL=1.15 Plate DOL=1.15; Category III; Exp. C; Partially Exp.; Ct=1.1
 4) Unbalanced snow loads have been considered for this design.
 5) This truss has been designed for greater of min roof live load of 12.0 psf or 1.00 times flat roof load of 25.4 psf on overhangs non-concurrent with other live loads.
 6) This truss has been designed for a 10.0 psf bottom chord live load nonconcurrent with any other live loads.
 7) Provide mechanical connection (by others) of truss to bearing plate capable of withstanding 170 lb uplift at joint B and 170 lb uplift at joint F.
 8) This truss is designed in accordance with the 2012 International Building Code section 2305.1 and referenced standard ANSI/TP1-1.

LOAD CASE(S) Standard

Job B081701547	Truss T01	Truss Type GABLE	Qty 1	Ply 1	Hastings - Willapong Knoll School
Borchardt Building & Supply, Nappanee, IN 46550 AS					Job Reference (optional)
					61605168 9/2017 MITek Industries, Inc. Fri Aug 11 10:32:41 2017 Page 1
					ID: x9aeeb71dXRF7E2N10VHAdyp_61jk_dJfAaWc2QuYE_w2WM6WGJZmHRFFXmWshyoyvq

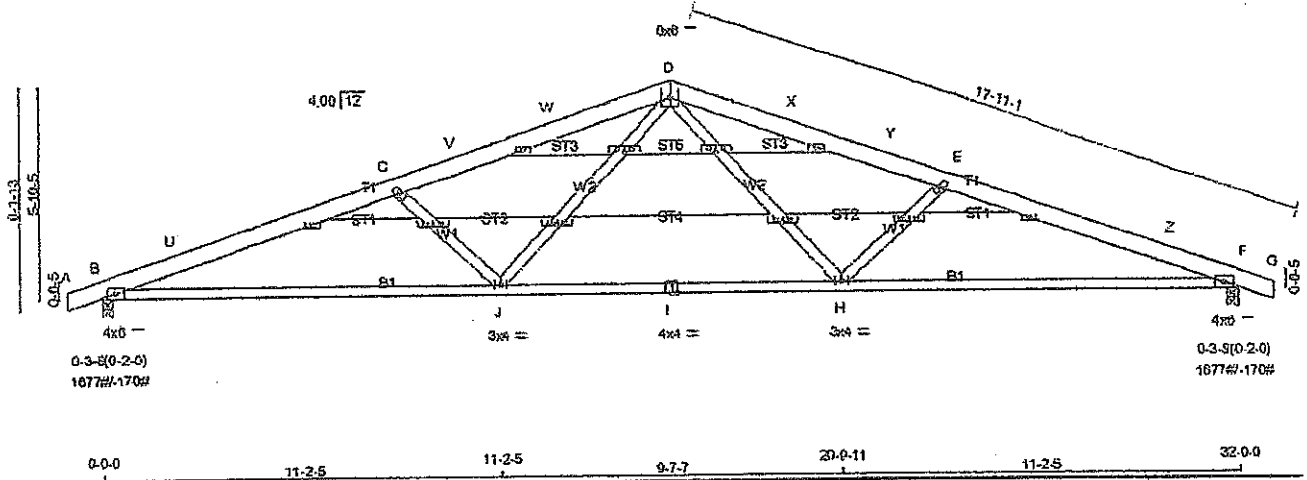
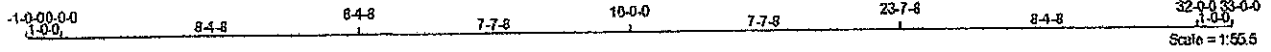

Plate Offsets (X-Y) (B=0-2-5,0-1-0) (C=0-2-5,0-1-0) (D=0-2-5,0-1-0) (E=0-2-5,0-1-0)	
LOADING (psf)	SPACING- 2-0-0
TCLL (roof) 30.0	Plate Grip DOL 1.15
Snow (P/F/S) 25.4/30.0	Lumber DOL 1.15
TCOL 10.0	Rep Stress Incr YES
BCOL 0.0	Code IBC2012/TP12007
BCOL 10.0	Matrix-S
CSL	DEFL In (loc) I/dell Lad
TC 0.53	Ver(LL) -0.38 F-H >999 240
BC 0.08	Ver(TL) -0.07 F-H >992 180
WB 0.24	Horz(TL) 0.17 F n/a n/a
Matrix-S	Weight: 205 lb FT = 20%

LUMBER-
TOP CHORD 2x4 SP No.1
BOT CHORD 2x4 SP No.1
WEBS 2x4 SP No.2
OTHERS 2x4 SP No.2

BRACING-
TOP CHORD Structural wood sheathing directly applied or 3-4-5 copurlins.
BOT CHORD Rigid ceiling directly applied or 2-2-0 cbracing.
MITek recommends that Stabilizers and required cross bracing be installed during truss erection, in accordance with Stabilizer Installation guide.

REACTIONS (lb/size) B=1521/0-3-3 (min 0-2-0) F=1521/0-3-3 (min 0-2-0)
Max Horiz B=80(LC 14)
Max UpR/B=170(LC 16) F=170(LC 16)
Max Grav B=1677(LC 2) F=1677(LC 2)

FORCES (lb) -Max Comp, Max Ten - All forces 250 (lb) or less except when shown.
TOP CHORD E-U=3708/1023, C-U=3041/1049, D-V=3160/865, V-W=3087/898, D-W=3079/912, D-X=2079/912, X-Y=3097/908, E-Y=3169/885
E-Z=2641/1049, F-Z=3709/1023
BOT CHORD B-J=603/3436, I-J=513/2318, H-I=513/2318, F-H=603/3430
WEBS D-H=177/961, E-H=731/378, D-J=177/961, C-J=731/378

- NOTES-
- 1) Unbalanced roof live loads have been considered for this design.
 - 2) Wind: ASCE 7-10; Vult=120mph (3-second gust) Vasd=85mph; TCOL=0.0psf; BCOL=0.0psf; h=20ft; B=49ft; L=33ft; eave=2ft; Cat. III; Exp C; enclosed; MWFRS (directional) and C-C Corner(3) 1-0-0 to 2-2-8. Exterior(2) 2-2-6 to 10-0-0, Corner(3) 10-0-0 to 10-2-6 zones; eave/over left and right exposed; end vertical left and right exposed C-C for members and forces & MWFRS for readings shown; Lumber DOL=1.80 plate grip DOL=1.60
 - 3) Truss designed for wind loads in the plane of the truss only. For studs exposed to wind (normal to the face), see Standard Industry Gable End Details as applicable, or consult qualified building designer as per ANS/ITP 1.
 - 4) TCLL: ASCE 7-10; P=30.0 psf (roof live load); Lumber DOL=1.15 Plate DOL=1.15; Pp=30.0 psf (ground snow); Pf=25.4 psf (flat roof snow); Lumber DOL=1.15 Plate DOL=1.15; Category III; Exp C; Partially Exp; Cf=1.1
 - 5) Unbalanced snow loads have been considered for this design.
 - 6) This truss has been designed for greater of min roof live load of 12.0 psf or 1.00 times flat roof load of 25.4 psf on overhangs non-concurrent with other live loads.
 - 7) All plates are 2x5 MT20 unless otherwise indicated.
 - 8) Horizontal gable studs spaced at 2-0-0 oc.
 - 9) This truss has been designed for a 10.0 psf bottom chord live load nonconcurrent with any other live loads.
 - 10) Provide mechanical connection (by others) of truss to bearing plate capable of withstanding 170 lb up/ft at joint B and 170 lb up/ft
 - 11) This truss is designed in accordance with the 2012 International Building Code section 2308.1 and referenced standard ANS/ITP

LOAD CASE(S) Standard

Job	Truss	Truss Type	Qty	Ply	Headings: Whispering Knoll School
B081701547	S04	GABLE	1	1	Job Reference (optional)
Bridgeway Building & Supply, Nappanee IN 46550 AS					84005 Mar 02017 MITek Industries, Inc. Fri Aug 11 10:32:40 2017 Page 1
					ID:9eeeb71d0RF7E2N0VHADyp_8F-PYQUJGJ9ytlvZGOfcML77bJ7kATvDB15IzZf0yoyur

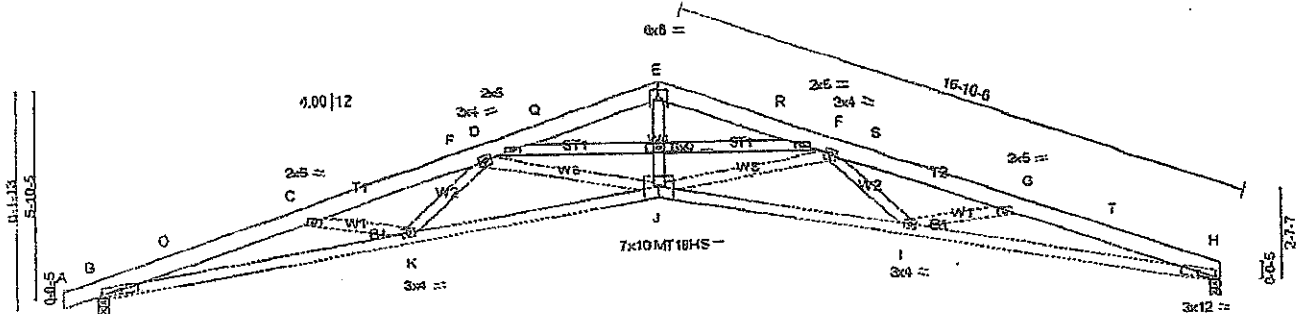
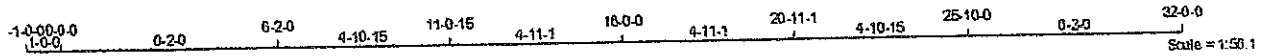

0.0-0	3-10-3	8-10-3	7-1-13	18-0-0	7-1-13	23-1-13	3-10-3	32-0-0
-------	--------	--------	--------	--------	--------	---------	--------	--------

LOADING (psf)	SPACING-	3.0-0	CSL	DEFL	in (loc)	1/2in	L/H	PLATES	GRIP
TOLL (roof)	Plate Grip DOL	1.15	T/C 0.6J	Ver(LL)	-0.65	I-J	>287	MT20	214/190
Snow (P/R/g)	Lumber DOL	1.15	BC 0.71	Ver(TL)	-1.33	J-K	>287	MT18MS	214/190
TCDL	Rep Stress Incr	YES	WB 0.63	Horz(TL)	0.60	H	n/a		
BCL	Code IBC2012/IFC2007		Matkx-S						Weight: 170 lb FT = 20%
BCL									
BCL									

LUMBER-
 TOP CHORD 2x6 SP No.1
 BOT CHORD 2x4 SP 2400F 2.0E
 WEBS 2x4 SP No.2
 OTHERS 2x4 SP No.2

BRACING-
 TOP CHORD Structural wood sheathing directly applied or 2x5-D or purins.
 BOT CHORD Rigid ceiling directly applied or 0-8-11 oak bracing

MITek recommends that stabilizers and required cross bracing be installed during truss erection, in accordance with Stabilizer Installation guide.

REACTIONS: (k/size) H=1438.0-3.8 (min. 0-1-8), B=15220-3.8 (min. 0-1-8)
 Max Horz B=80(LC 15)
 Max Uplift H=127(LC 16), B=171(LC 16)
 Max Grwt H=1584(LC 2), B=1679(LC 2)

FORCES: (lb) -Max. Comp./Max. Ten. - All forces 250 (lb) or less except when shown.
 TOP CHORD B-O=-6535/752 C-O=-6457/795 G-P=-6103/625 D-P=-6006/637 D-G=-4761/527 E-O=-4691/539 E-R=-4601/548 F-R=-4751/530
 F-S=-8116/650 G-S=-8211/640 G-T=-6498/620 H-T=-6571/608
 BOT CHORD B-K=-688/154 J-K=-663/565 I-J=-554/5073 H-I=-7208/191
 WEBS E-J=-210/2650 F-J=-1254/215 I-I=0/495 G-I=-358/222 D-J=-1241/214 D-K=-6491 C-K=-332/180

- NOTES-**
- Unbalanced roof live loads have been considered for this design.
 - Wind: ASCE 7-10; V_{ult}=120mph (3-second gust) V_{used}=95mph; TCOL=6.0psf; BCL=0.0psf; h=20ft; B=4ft; L=30ft; eave=4ft; Cat. III; Exp. C; enclosed; MWFRS (directional) and C-C Exterior(2) 1-0-0 to 2-2-8 Interior(1) 2-2-8 to 18-0-0, Exterior(2) 18-0-0 to 10-2-8 zone; cantilever left end right exposed; end vertical left and right exposed C-C for members and forces & MWFRS for reactions shown; Lumber DOL=1.00 plate grip DOL=1.60
 - Truss designed for wind loads in the plane of the truss only. For studs exposed to wind (normal to the face), see Standard Industry Gable End Details as applicable, or consult qualified building designer as per ANSI/TPI 1.
 - TOLL ASCE 7-10; Pre=20.0 psf (roof live load Lumber DOL=1.15 Plate DOL=1.15); P-g=30.0 psf (ground snow); P_f=25.4 psf (flat roof snow); Lumber DOL=1.15 Plate DOL=1.15; Category III; Exp. C; Partially Exp.; Ct=1.1
 - Unbalanced snow loads have been considered for this design.
 - This truss has been designed for greater of min roof live load of 12.0 psf or 1.00 times flat roof load of 25.4 psf on overhangs non-concurrent with other live loads.
 - All plates are MT20 plates unless otherwise indicated.
 - Horizontal gable studs spaced at 2-0-0 oc.
 - This truss has been designed for a 10.0 psf bottom chord live load nonconcurrent with any other live loads.
 - Seaming at joint(s) H, B considers parallel to grain value using ANSI/TPI 1 angle to grain formula; Building Code
 - Provide mechanical connection (by others) of truss to bearing plate capable of withstanding 1271b up/ft at J
 - This truss is designed in accordance with the 2012 International Building Code section 2305.1 and reference

LOAD CASE(S) Standard

Job B081701547	Truss S03	Truss Type SCISSORS	City 16	Fly 1	Headings: Whelping Knoll School
-------------------	--------------	------------------------	------------	----------	---------------------------------

Berkholder Building & Supply, Nappanee, IN 46550, AS

Job Reference (optional)
B:100 S:18r 9 2017 MITek Industries, Inc. Fri Aug 11 10:32:30 2017 Page 1
ID:xd9eeeb71dXRF7E2N10VtAdyp_8-nL_s03z9K_nkE4cpdUu35AyBni7gHkdy3SpPnUy0jvs

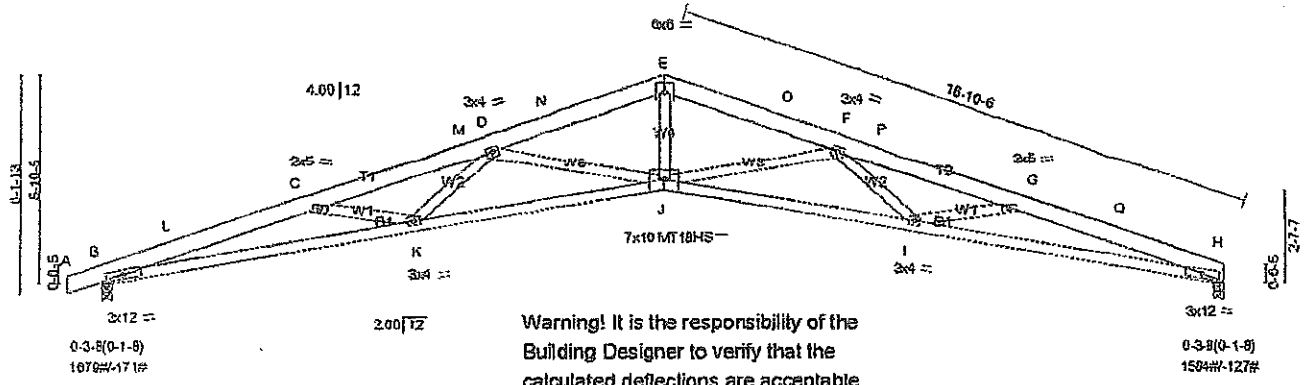
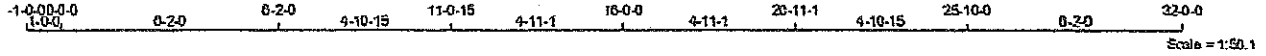

LOADING (psf)	SPACING	CSI	DEFL	PLATES	GRIP
TCLL (roof) 30.0	34-0	TC 0.60	in (loc) U/dell L/d	MT20	244/100
Snow (P/Fg) 25.4/30.0	Plate Grip DOL 1.15	BC 0.71	Vert(LL) -0.65 I-J >587 240	MT18H5	214/100
TCDL 10.0	Lumber DOL 1.15	WB 0.03	Vert(TL) -1.33 J-K >287 180		
BCLL 0.0	Rep Stress Incr YES	Matrix-S	Horz(TL) 0.09 H n/a i/c		
BCDL 10.0	Code IBC2312(TP)2007			Weight: 168 lb	FT = 20%

LUMBER-
 TOP CHORD 2x6 SP No.1
 BOT CHORD 2x4 SP 2400F 2 0E
 WEBS 2x4 SP No.2

BRACING-
 TOP CHORD Structural wood sheathing directly applied or 2S-0 occ puline.
 BOT CHORD Rigid ceiling directly applied or 0-8-11 occ bracing

MITek recommends that Stabilizers and required cross bracing be installed during truss erection, in accordance with Stabilizer Installation guide.

REACTIONS: (lb/size) H=1438/0-3-8 (min. 0-1-8), B=1522/0-3-8 (min. 0-1-8)
 Max Horz B=60(LC 15)
 Max Uplift H=127(LC 16), B=171(LC 10)
 Max Grav H=1584(LC 2), B=1670(LC 2)

FORCES: (lb) - Max. Comp./Max. Ten. - All forces 250 (lb) or less except when shown.
 TOP CHORD B-L=7535/752, C-L=6457/765, C-M=6163/625, D-M=6000/637, D-N=4751/527, E-N=4691/539, E-Q=4691/546, F-D=4751/526
 F-P=6116/650, G-P=6211/640, G-Q=6498/620, H-Q=6571/608
 BOT CHORD B-K=680/615, J-K=593/565, J-L=554/507, H-H=7280/191
 WEBS E-J=218/256, F-J=1254/215, F-I=6465, G-I=338/222, D-J=1241/214, D-K=6491, C-K=338/136

- NOTES-**
- 1) Unbalanced roof live loads have been considered for this design.
 - 2) Wind: ASCE 7-10; Vult=120mph (3-second gust) Vdes=95mph; TCCL=8.0psf; BCCL=6.0psf; h=20ft; E=49t; L=32ft; eave=4ft; Cat. III; Exp. C, enclosed; MWFRS (directional) and C-C Exterior (2) -1-0-0 to 2-2-0, Interior (1) 2-2-0 to 18-0-0, Exterior (2) 10-0-0 to 10-2-0 zone; cantilever left and right exposed; end vertical (left and right exposed) C-C for members and forces & MWFRS for reactions shown; Lumber DOL=1.60 plate grip DOL=1.60
 - 3) TCLL: ASCE 7-10; Pr=30.0 psf (roof live load); Lumber DOL=1.15 Plate DOL=1.15; Pg=30.0 psf (ground snow); P1=25.4 psf (flat roof snow); Lumber DOL=1.15 Plate DOL=1.15; Category III, Exp. C; Partially Exp.; Cf=1.1
 - 4) Unbalanced snow loads have been considered for this design.
 - 5) This truss has been designed for greater of min roof live load of 12.0 psf or 1.00 times flat roof load of 25.4 psf on overhangs non-occurrent with other live loads.
 - 6) All plates are MT20 plates unless otherwise indicated.
 - 7) This truss has been designed for a 10.0 psf bottom chord live load nonoccurrent with any other live loads.
 - 8) Bearing at joint(s) H, B, considers parallel to grain value using ANSITPI 1 angle to grain formula. Building designer should verify capacity of bearing surface.
 - 9) Provide mechanical connection (by others) of truss to bearing plate capable of withstanding 127 lb up/lift at joint H and 171 lb up/lift at joint E.
 - 10) This truss is designed in accordance with the 2012 International Building Code section 2308.1 and referenced standard ANSITPI 1.

LOAD CASE(S) Standard

Job B031701547	Truss SIZ	Truss Type Sasscr	Qty 3	Ply 1	Headings- Whispering Knoll School
Berkholder Building & Supply, Napponee, IN 46530 AS					Job Reference (optional)

B-1008 Mar 0 2017 A0Tek Industries, Inc. Fri Aug 11 10:32:37 2017 Page 1
ID: x9eeab71dXR7E2N0VHADyp_0l-qzMeI 748NY7PxaDhCRQ_g5d2-ty3Jpp9t6c8Kjcyrvu

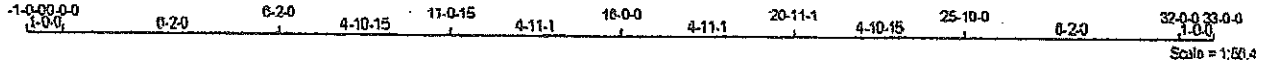

Scale = 1/80.4

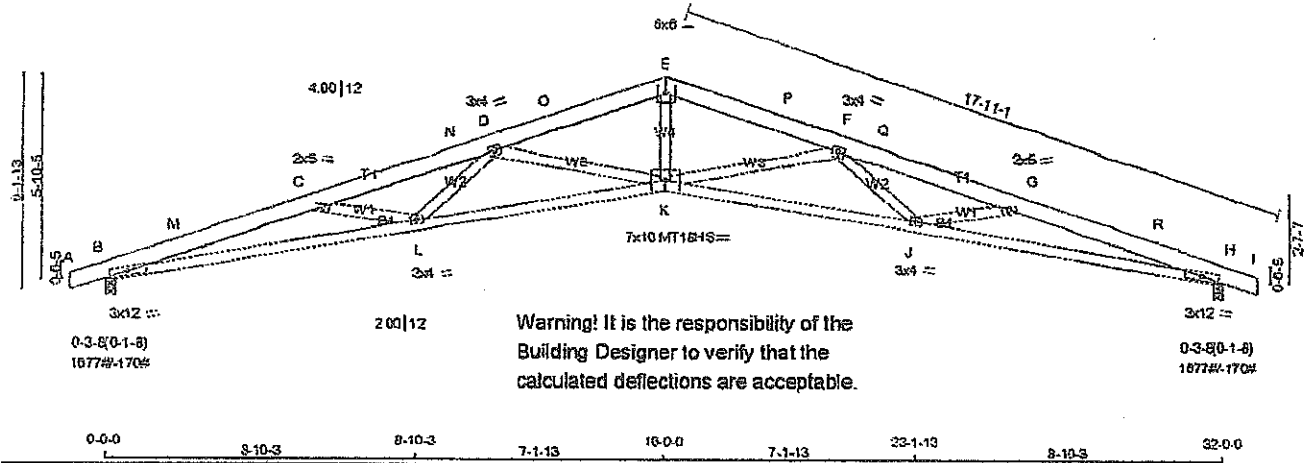

LOADING (psf)	SPACING- 24-0	CSL	DEFL. in (loc)	PLATES	GRIP
TCL (roof) 30.0	Plate Grip DOL 1.15	TC 0.58	Vert(LL) -0.65 J-K >500 240	MT20 244/100	
Snow (P/Pg) 25.4/30.0	Lumber DOL 1.15	BC 0.70	Vert(TL) -1.32 J-K >282 180	MT18x6 244/100	
TCDL 10.0	Rep Stress Incr YES	WB 0.63	Horz(TL) 0.60 H n/a n/a		
BCL 0.0	Code IBC2012/TP12007	Matrix-S			Weight 160 lb FT = 20%
BCDL 10.0					

LUMBER-
 TOP CHORD 2x4 SP No.1
 BOT CHORD 2x4 SP 2400# 20E
 WEBS 2x4 SP No.2

BRACING-
 TOP CHORD Structural wood sheathing directly applied at 24-2 oc purlins.
 BOT CHORD Rigid ceiling directly applied or 10-0-0 oc bracing

Mitek recommends that Stabilizers and required cross bracing be installed during truss erection, in accordance with Stabilizer installation guide.

REACTIONS. (k/size) B=1521/0-3-8 (min 0-1-8), H=1521/0-3-8 (min. 0-1-8)
 Max Horz B=30/L C 14
 Max Up/B=170(LC 10), H=170(LC 10)
 Max Grav B=1077(LC 2), H=1077(LC 2)

FORCES. (lb) -Max Comp./Max Ten. - All forces 250 (lb) or less except when shown.
 TOP CHORD B-M=0527/733, C-N=0448/742, C-N=0181/004, O-N=0089/015, D-O=4741/517, E-O=4681/520, E-P=4681/525, F-P=4741/513, F-Q=0089/019, G-Q=0181/004, G-R=0448/742, H-R=0527/733
 BOT CHORD B-L=001/0140, K-L=535/555, J-K=593/560, H-J=008/0140
 WEBS E-K=109/2554, F-K=1247/215, F-J=0/491, G-J=338/187, D-K=1297/215, D-L=0/491, C-L=333/187

- NOTES-**
- 1) Unbalanced roof live loads have been considered for this design.
 - 2) Wind: ASCE 7-10; Vw(120mph (2-second gust) Vw50=95mph; TCCL=6.0psf; BCDL=6.0psf; h=20ft; E=48L; L=32ft; eave=4ft; Cat III; Exp C, enclosed; MWFRS (directional) and C-C Exterior (2) - 1-0-0 to 2-2-0 Interior (1) 2-2-0 to 16-0-0, Exterior (2) 16-0-0 to 18-2-0 zone; cantilever left and right exposed; end vertical left and right exposed C-C for members and forces & MWFRS for reactions shown; Lumber DOL=1.00 plate grip DOL=1.00
 - 3) TCL: ASCE 7-10; Pr=30.0 psf (roof live load); Lumber DOL=1.15 Plate DOL=1.15; Pg=30.0 psf (ground snow); Pt=25.4 psf (flat roof snow); Lumber DOL=1.15 Plate DOL=1.15; Category III; Exp C; Partially Exp; Cf=1.1
 - 4) Unbalanced snow loads have been considered for this design.
 - 5) This truss has been designed for greater of min roof live load of 12.0 psf or 1.00 times flat roof load of 25.4 psf on overhangs non-concurrent with other live loads.
 - 6) All plates are MT20 plates unless otherwise indicated.
 - 7) This truss has been designed for a 10.0 psf bottom chord live load nonconcurrent with any other live loads.
 - 8) Bearing at joint(s) B, H considers parallel to grain value using ANSITPI 1 angle to grain formula. Building designer should verify capacity of bearing surface.
 - 9) Provide mechanical connection (by others) of truss to bearing plate capable of withstanding 170 lb uplift at joint B and 170 lb uplift at joint H.
 - 10) This truss is designed in accordance with the 2012 International Building Code section 2308.1 and referenced standard ANSITPI 1.

LOAD CASE(S) Standard

Job B081701547	Title SOF	Truss Type GABLE	Qty 1	Ply 1	Job Reference (optional) Hastings-Whispering Knoll School
-------------------	--------------	---------------------	----------	----------	--

8100 Mar 9 2017 MIT Industries, Inc. Fri Aug 11 10:32:30 2017 Page 1
 ID: B081701547 (0VHAdyp_8f-MnBzQy6SHQ8nnL17VwARTYSXV644NvNUUbiAAyoyv)

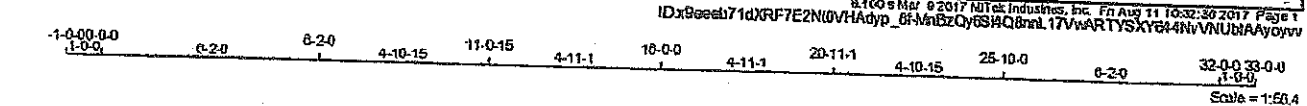

Warning! It is the responsibility of the Building Designer to verify that the calculated deflections are acceptable.

LOADING (psf)	SPACING-	CSI	DEFL.	PLATES
TCLL (roof) 30.0	2'-0"	TC 0.50	in (top) Uds4 Lfd	MT20 2x4/190
Snow (P179) 25.4/30.0	Plate Grip DOL 1.15	BC 0.70	Ver(LL) -0.65 J-K >590 240	MT18H5 2x4/190
TCOL 10.0	Lumber DOL 1.15	WB 0.03	Ver(TL) -1.32 J-K >282 180	
SCCL 0.0	Rep Stress Incr YES	Matrix-S	Horz(TL) 0.60 H n/a n/a	
BCOL 10.0	Code IBC2012/TP1207			Weight 182 lb FT = 20%

LUMBER-
 TOP CHORD 2x6 SP No.1
 BOT CHORD 2x4 SP 240CF 2 OE
 WEBS 2x4 SP No.2
 OTHERS 2x4 SP No.2

BRACING-
 TOP CHORD Structural wood sheathing directly applied or 2x2-2 cc purlins.
 BOT CHORD Rigid ceiling directly applied or 10-0-0 cc bracing

MITek recommends that Stabilizers and required cross bracing be installed during truss erection. In accordance with Stabilizer Installation guide.

REACTIONS: (lb/size) B=1521/0-3-3 (min. 0-1-5), H=1521/0-3-3 (min. 0-1-5)
 Max Horz B=90(L.C.14)
 Max Up/IRB=170(L.C.16), H=170(L.C.10)
 Max Grw B=1677(L.C.2), H=1677(L.C.2)

FORCES: (lb) -Max. Comp./Max. Ten. - All forces 250 (5) or less except when shown.
 TOP CHORD B-P=6527/733, C-P=6449/745, C-Q=6184/804, D-Q=6089/815, O-R=4741/517, E-R=4881/529, E-S=4691/525, F-S=4741/513
 F-T=6089/810, G-T=6184/808, G-U=6449/748, H-U=6527/738
 BOT CHORD B-L=661/1146, K-L=535/553, J-K=5135/550, H-J=6089/814
 E-K=193/254, F-K=1247/215, F-J=3491, G-J=333/187, D-K=1247/215, D-L=6401, C-L=339/187

- NOTES-
- Unbalanced roof live loads have been considered for this design.
 - Wind: ASCE 7-10; Vel=120mph (3-second gust) Vsea=55mph; TCOL=0.0psf; BCOL=0.0psf; h=20ft; B=48ft; L=22ft; eave=1ft; Cat. III; Exp. C; enclosed; MWFRS (directional) and C-C Exterior(2) -1-0-0 to 2-2-0, Interior(1) 2-2-0 to 16-0-0, Exterior(2) 16-0-0 to 19-2-0 zone; can/lever left and right exposed; end vertical left and right exposed C-C for members and fascia & MWFRS for reactions shown; Lumber DOL=1.60 plate grip DOL=1.60
 - Truss designed for wind loads in the plane of the truss only. For studs exposed to wind (normal to the face), see Standard Industry Gable End Details as applicable, or consult qualified building designer as per ANSI/TP1-1.
 - TCLL: ASCE 7-10; P=30.0 psf (roof live load), Lumber DOL=1.15 Plate DOL=1.15; Pg=30.0 psf (ground snow), P1=25.4 psf (flat roof snow), Lumber DOL=1.15 Plate DOL=1.15; Category III; Exp. C; Partially Exp. C=1.1
 - Unbalanced snow loads have been considered for this design.
 - This truss has been designed for greater of min roof live load of 12.0 psf or 1.00 times flat roof load of 25.4 psf on overhangs non-concurrent with other live loads.
 - All plates use MT20 plates, unless otherwise indicated.
 - Horizontal gable studs spaced at 2'-0" oc.
 - This truss has been designed for a 10.0 psf bottom chord live load nonconcurrent with any other live loads.
 - Bearing at joint(s) B, H considers parallel to grain value using ANSI/TP1-1 angle to grain formula. Building designer should verify capacity of bearing surface.
 - Provide mechanical connection (or others) of truss to bearing plate capable of withstanding 170 lb up at joint B and 170 lb up at joint H.
 - This truss is designed in accordance with the 2012 International Building Code section 2308.1 and referenced standard ANSI/TP1-1.

LOAD CASE(S) Standard